

APRIL

Radio-Electronics

TELEVISION • SERVICING • HIGH FIDELITY

Setting Up the Zenith and RCA Color TV Sets

Versatile Transistor Tester

More Stereo Multiplex Listings

Electroluminescent Flashlight

HUGO GERNSBACK,
Editor-in-chief

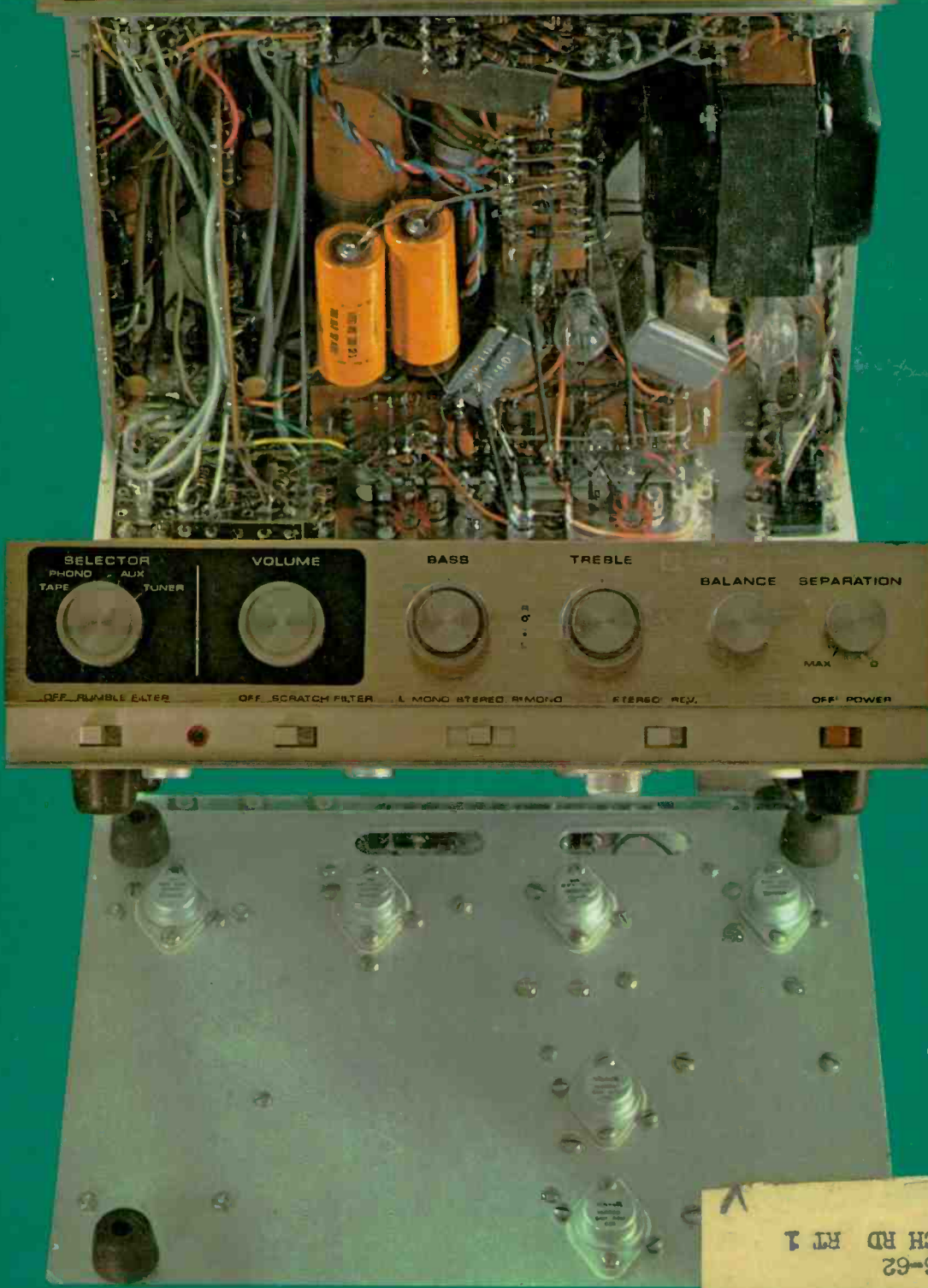

New 50-Watt Stereo Amplifier is All-Transistor

See page 4

50c

A L PRIDDY 6-62
BOX 133 BRANCH RD FT 1
HELLE W VA

TRIPLETT

ACTUAL SIZE

USES UNLIMITED:

- Field Engineers
- Application Engineers
- Electrical, Radio, TV,
and Appliance Servicemen
- Electrical Contractors
- Factory Maintenance Men
- Electronic Technicians
- Home Owners, Hobbyists



MODEL 310

complete
VOLT-OHM-
MILLIAMMETER



World's Largest Selling POCKET SIZE V-O-M

FEATURES:

- 1 Hand size and lightweight, but with the features of a full-size V-O-M.
- 2 20,000 ohms per volt DC; 5,000 AC.
- 3 EXCLUSIVE SINGLE SELECTOR SWITCH speeds circuit and range settings. The first miniature V-O-M with this exclusive feature for quick, fool-proof selection of all ranges.

SELF-SHIELDED Bar-Ring instrument; permits checking in strong magnetic fields • Fitting interchangeable test prod tip into top of tester makes it the common probe, thereby freeing one hand • UNBREAKABLE plastic meter window • BANANA-TYPE JACKS—positive connection and long life.

■ Price—only **\$37.50**; leather case **\$3.20**.

Available For Immediate Delivery From Your Triplet Distributor's Stock



MODEL 100

The most comprehensive test set in the Triplet line is Model 100 V-O-M Clamp-On-Ammeter Kit, now available at distributors. The world's most versatile instrument—a complete accurate V-O-M plus a clamp-on-ammeter with which you can take measurements without stripping the wires. Handsome, triple-purpose carton holds and displays all the components: Model 310 miniaturized V-O-M, Model 10 Clamp-On-Ammeter, Model 101 Line Separator, No. 311 Extension leads, and a leather carrying case, which neatly accommodates all the components. Model 101 literally makes it possible to separate the two sides of the line when using Model 10. Extension leads permit use of Model 10 at a distance from the V-O-M. Complete Model 100 is only

\$64.50

THE TRIPPLETT ELECTRICAL INSTRUMENT COMPANY, BLUFFTON, OHIO

MANUFACTURERS OF PANEL AND PORTABLE INSTRUMENTS; ELECTRICAL AND ELECTRONIC TEST EQUIPMENT

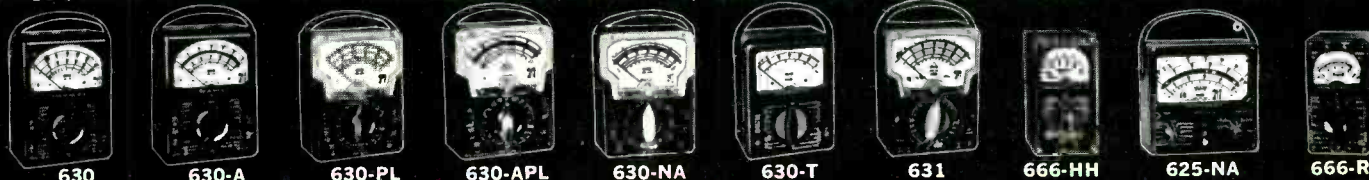

FOR EVERY PURPOSE—THE WORLD'S MOST COMPLETE LINE OF V-O-M'S

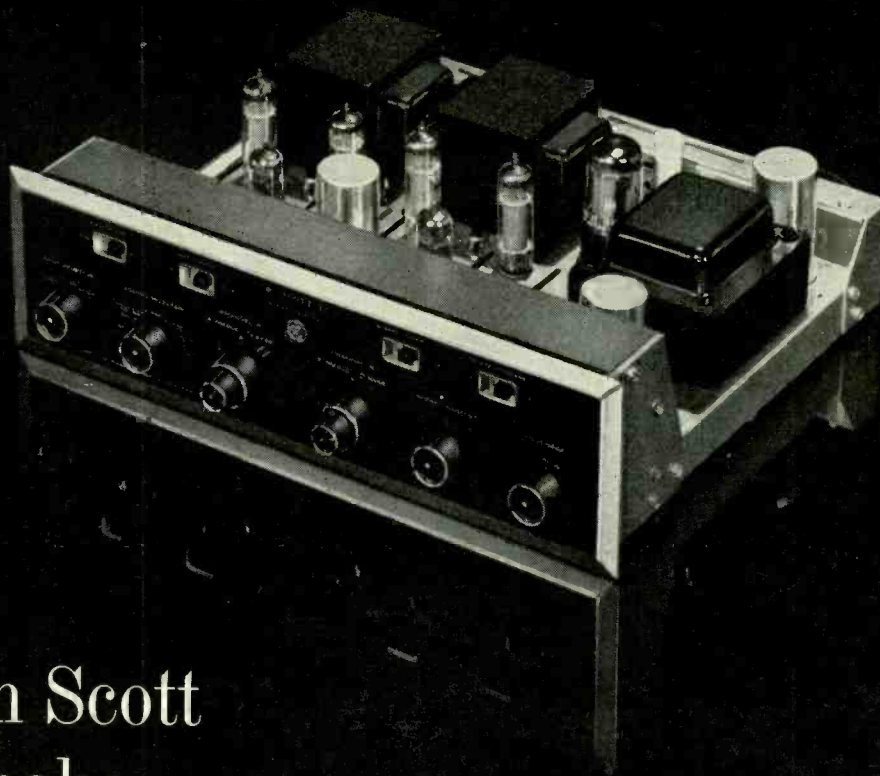

Hermon Scott could make this new kit for \$30 less, If...

Hermon Scott faced a basic choice . . . bring out his new LK-48 amplifier kit at \$124.95 or make it to sell for \$30 less like many other amplifier kits. All his engineering department had to do was make a few compromises.

The LK-48 is rated at 48 watts. By using a smaller power supply, ordinary output transformers, and pushing the output tubes to their limits, the amplifier might still produce 48 watts at 1000 cycles where many amplifier kits are rated. But measured at 20 cycles, where Scott engineers feel power is really important, output would be down considerably. No compromise was made. The LK-48 *actually* produces 28 watts per channel at 20 cycles, and delivers full power throughout the audio range.

Many kits use a one color instruction book. Hermon Scott decided to continue to use full color to insure factory-built performance, even at the hands of a novice.

Important Scott engineering extras like the all-aluminum chassis, DC operated preamp heaters and unique hum-null balancing could have been eliminated. Hum would have been audibly higher and distortion at levels normal to many kits, but Hermon Scott felt that the kit builder was entitled to the same performance he has come to expect from Scott factory-wired units.

Yes . . . Hermon Scott could have made the LK-48 to sell for \$30 less . . . but it would have meant compromising life-long standards. This is something he would never do. You can choose any Scott kit with complete confidence — the LK-48, the LK-72 80 watt complete stereo amplifier, the LK-150 130 watt stereo power amplifier, the LC-21 professional preamplifier, the LT-110 multiplex tuner, LT-10 FM tuner or the LM-35 multiplex adaptor. These superb kits have all the features and performance you've come to expect from the world's leader in audio engineering.

H. H. SCOTT

H. H. SCOTT INC., 111 Powdermill Rd., Maynard, Mass. Dept. 570-04

Please rush me your new full-color brochure telling about Scott's full line of superb stereo kits.

Name

Address

City State

Export: Morhan Exporting Corp., 458 Broadway, N.Y.C.
Canada: Atlas Radio Corp., 50 Wingold Ave., Toronto.
Prices slightly higher West of Rockies.

Radio-Electronics

Formerly RADIO CRAFT — Incorporating SHORT WAVE CRAFT — TELEVISION NEWS — RADIO & TELEVISION*

APRIL 1962
VOL. XXXIV No. 4

editorial

Hugo Gernsback 31 Electronic Germ Eradication

electronics

- Reginald W. Neale 38 Battery-Powered Electroluminescent Emergency Lamp
Portable unit uses new principle, is easy to build
- Mohammed Ulysses Fips 55 New—Electronic Razor
- John Collins 57 Solve Your Problems with Kirchhoff's Laws
Take the mystery out of those series-parallel circuits
- 66 What's Your EQ?
Answers to March puzzles on page 80

test instruments

- Capt. W. B. Bernard 42 Check Transistors 3 Ways
Get an accurate picture of transistor quality
- Homer L. Davidson 64 Substitution Box for Power Resistors
One-evening construction job you'll appreciate for years
- Wayne Lemons 71 Single Instrument for Color Servicing
Equipment Report on a combination color bar/dot/crosshatch generator

television

- Larry Steckler 45 Tube Layouts in TV Sets
General Electric 1961-1962
- Wayne Lemons 51 You Can Set Up Color
Procedure for the Zenith and RCA receivers
- Jack Darr 60 Service Clinic
Avoid callbacks on those marginal sets
- T. E. Duvall 68 TV Set Uses 6 Compactrons
Entire set has total of 10 tubes

industrial electronics

- Daniel M. Costigan 32 The Drive-in—Electronic Maze
How the audio system works
- S. A. Erceg 75 Sensor Controls Liquid Levels
Maintains level of any conductive liquid
- and N. J. Chervenak 79 Industrial Electronics Dictionary
From self-repeating timer to univibrator
- Ed Bukstein 82 Measure Torque with Electronics
- A. V. J. Martin

radio

- Leonard E. Geisler 47 Servicing CB Transistor Transceivers
Get into the fastest-growing service field!
- Stanley Leinwolf 50 SW Propagation Forecast
March 15—April 15
- George D. Philpott 53 Transistor Antenna Coil
- 59 Variable-Time-Constant Avc

what's new

- 54 Pictorial reports of new developments

audio—high fidelity—stereo

- A. V. J. Martin 34 Audio—Simple but Good
- Norman Kramer 35 New Directions in Hi-Fi Amplifiers (Cover Feature)
All-transistor stereo amplifier for the audiophile
- 40 FM Stereo Multiplex Equipment
Listing brings the October 1961 directory up to date
- R. C. Sandison 44 Improving Inexpensive Amplifiers
- Milton I. Ravich 83 PA Under Adverse Conditions

the departments

- | | | | |
|-------------------|-------------------------------|-------------------------|------------------|
| 22 Correspondence | 104 New Patents | 6 News Briefs | 98 Technotes |
| 108 New Books | 85 New Products | 102 Noteworthy Circuits | 105 Try This One |
| 93 New Literature | 95 New Tubes & Semiconductors | 100 Technicians' News | 103 50 Years Ago |

Over 50 Years of Electronic Publishing

EDITOR-IN-CHIEF AND PUBLISHER
Hugo Gernsback

EDITOR

M. Harvey Gernsback

MANAGING EDITOR

Fred Shunaman

TECHNICAL EDITOR

Robert F. Scott, W2PWG

ASSOCIATE EDITOR

Larry Steckler

EDITORIAL ASSOCIATE

I. Queen

SERVICE EDITOR

Jack Darr

TECH. ILLUSTRATION DIRECTOR

Wm. Lyon McLaughlin

ART ASSOCIATE

Fred Neinast

DIRECTOR OF PRODUCTION

Elizabeth Stalcup

DIRECTOR, ADVERTISING SALES

Lee Robinson

EASTERN SALES MANAGER

John J. Lamson

CIRCULATION MANAGER

G. Aliquo

DIRECTOR, NEWSSTAND SALES

Joseph L. Bund

PROMOTION MANAGER

Robert Fallath



Average Paid Circulation
Over 155,000

—on the cover—

(Story on page 35)

This one's done with mirrors.
The real Knight-Kit stereo
amplifier is in the middle. It
delivers 25 watts per channel
and uses a total of 20 trans-
istors.

Color original by Irving Kautman

Gernsback Publications, Inc.

EXECUTIVE, EDITORIAL, ADVERTISING OFFICES

154 W. 14 St., New York 11, N.Y.
Telephone AL 5-7755

CHAIRMAN OF THE BOARD

Hugo Gernsback

PRESIDENT

M. Harvey Gernsback

SECRETARY

G. Aliquo



Radio-Electronics is indexed in
Applied Science & Technology Index
(Formerly Industrial Arts Index)

*Trademark registered U. S. Pat. Office

GET YOUR ELECTRONICS-TV-RADIO HOME TRAINING FROM N.T.S. RESIDENT SCHOOL

BREAK THROUGH TO HIGHER PAY, GREATER JOB SECURITY

START NOW! Break through the Earning Barrier that stops "half-trained" men. N.T.S. "All-Phase" Training prepares you . . . at home in spare time . . . for a high-paying CAREER as a MASTER TECHNICIAN in Electronics — TV — Radio. One Master Course at One Low Tuition trains you for unlimited opportunities in All Phases: Servicing, Communications, Preparation for F.C.C. License, Broadcasting, Manufacturing, Automation, Radar and Micro-Waves, Missile and Rocket Projects.

A MORE REWARDING JOB . . . a secure future . . . a richer, fuller life can be yours! As an N.T.S.

MASTER TECHNICIAN you can go straight to the top in industry . . . or open your own profitable business.

Over 1 City Block of Modern School Facilities, Laboratories and Shops Housing Over 1,000 Students.

50,000 Graduates — all over the World — since 1905

BETTER . . . MORE COMPLETE . . . LOWER COST . . . WITH NATIONAL SCHOOLS' SHOP-METHOD HOME TRAINING!

BETTER . . . Training that is proved and tested in N.T.S. Resident School shops and laboratories, by a School that is the **OLDEST** and **LARGEST** of its kind in the world.

MORE COMPLETE . . . You learn **ALL PHASES OF** Television — Radio — Electronics.

LOWER COST . . . Other schools make several courses out of the material in **ONE MASTER COURSE . . .** and you pay more for less training than you get in our course at **ONE LOW TUITION!**

NATIONAL TECHNICAL SCHOOLS
WORLD-WIDE TRAINING SINCE 1905

THE SCHOOL BEHIND YOUR HOME-STUDY TRAINING

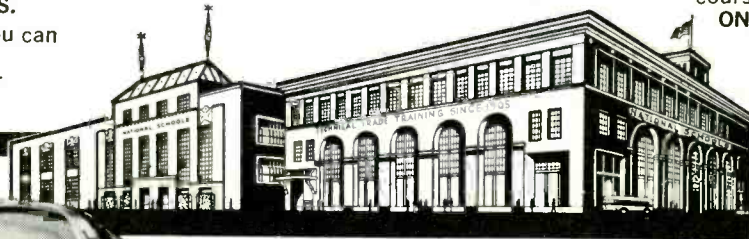

In these modern School Headquarters your Home Training is: Classroom-Developed, Lab-Studio Planned, Shop-Tested, Industry-Approved, Home Study-Designed.

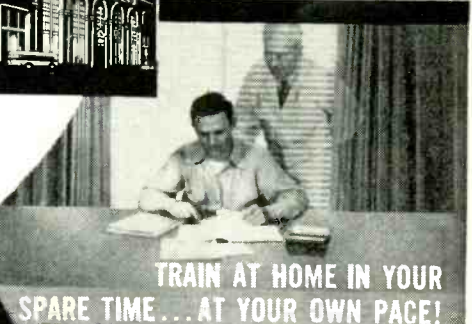
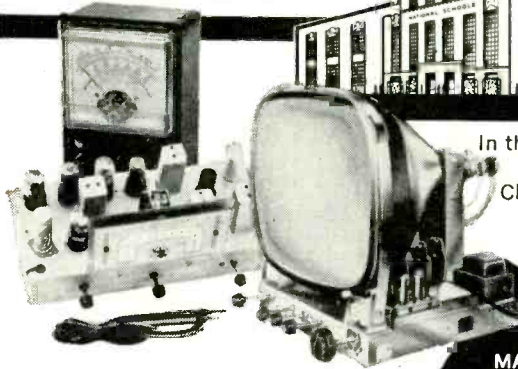

TRAIN AT HOME IN YOUR SPARE TIME . . . AT YOUR OWN PACE!

19 BIG KITS YOURS TO KEEP

- Friendly Instruction and Guidance
- Graduate Advisory Service
- Unlimited Consultation
- Diploma Recognized by Industry
- **EVERYTHING YOU NEED FOR SUCCESS**

N.T.S. IS NOT JUST A MAILING ADDRESS ON A COUPON

N.T.S. is a real school . . . a world famous training center since 1905. Thousands of men from all over the world come to train in our shops, labs, studios and classrooms.

You learn quickly and easily the N.T.S. Shop-Tested way. You get lessons, manuals, job projects, personal consultation from instructors as you progress. You build a Short-Wave, Long-Wave Superhet Receiver plus a large screen TV set from the ground up with parts we send you at no additional cost. You also get a Professional Multimeter for your practical job projects. The Multimeter will become one of your most valuable instruments in spare time work while training, and afterwards, too. Many students pay for their entire tuition with spare time work. You can, too . . . we show you how.

**SEND FOR INFORMATION NOW . . . TODAY!
IT COSTS YOU NOTHING TO INVESTIGATE**

After you graduate you can open your own TV-Radio repair business or go into high paying jobs like these: Communications Technicians, Hi-Fi, Stereo and Sound Recording Specialists, TV-Radio Broadcasting Technician, Technician in Computers & Missiles, Electronics Field Technician, Specialist in Micro-Waves and Servomechanisms, Expert Trouble Shooter, All-Phase Master Technician, TV-Radio Sales, Service and Repair.

RESIDENT TRAINING AT LOS ANGELES
If you wish to take your Electronics-TV-Radio training in our famous Resident School in Los Angeles — the oldest and largest school of its kind in the world — write for special Resident School catalog and information, or check special box in coupon.

MAIL COUPON NOW FOR FREE BOOK & ACTUAL LESSON

No obligation.
No salesman will call.



NATIONAL TECHNICAL SCHOOLS
WORLD-WIDE TRAINING SINCE 1905

Mail Now To
National Technical Schools, Dept. RG-42
4000 S. Figueroa St., Los Angeles 37, Calif.
Please rush FREE Electronics-TV-Radio "Opportunity" Book and Actual Lesson.

Name _____ Age _____
Address _____
City _____ Zone _____ State _____

Check here if interested ONLY in Resident Training at Los Angeles.
VETERANS: Give date of discharge _____



ACCREDITED MEMBER

NATIONAL TECHNICAL SCHOOLS

WORLD-WIDE TRAINING SINCE 1905

4000 SO. FIGUEROA ST., LOS ANGELES 37, CALIF., U. S. A.

News Briefs

Citizens Banders React

A federation of volunteer Citizens-band radio operators has been organized to provide aid to the authorities and their communities under local emergency conditions. The objectives of the organization are:

1—To provide a round-the-clock radio communications system, effectively supplementing police, fire, ambulance, hospital and civil defense efforts.

2—To promote correct and efficient use of Citizens-band radio.

The organization is known as the Radio Emergency Associated Citizens Teams (REACT), and is already functioning in Wisconsin. Membership is free, REACT being sponsored and supported by the Hallicrafters Co., Chicago communications equipment manufacturers. Since Citizens banders now number more than a quarter-million, it is felt the organization can become a valuable emergency service, especially in areas where existing communications facilities are limited.

Infrared Stabilizes Satellites

A "horizon sensor" that works with infrared, and therefore operates as well in darkness as in daylight, has been patented by Monty M. Merlen of Barnes Engineering Co. The device has been used in the US Air Force's Midas and Dis-

coverer programs, and in other NASA earth-orbiting and far-space projects. Two of them are used in the Project Mercury spacecraft. They detect pitch and roll and produce corrective signals that keep these space craft stable in flight.

The horizon sensor takes advantage of the fact that every object emits infrared energy, the amount being proportional to the fourth power of its absolute temperature (T^4). Thus, the earth, which has an average temperature of 280°K (45°F) in moderate zones, radiates far more energy than does outer space, which is approximately at absolute zero. To the thermistor infrared detector which forms the heart of the horizon sensor, the earth appears as a hot sphere whose edges are easily detected.

The horizon sensor described in the patent generates a conical scan by rotating a tilted mirror or prism some 1,800 times a minute. As the line of sight from the instrument cuts across the edge of the earth, the sudden change from the cold of outer space to the warm earth is sensed by the thermistor infrared detector and causes a change in voltage across this temperature-sensitive element. This signal, after amplification and processing, may provide corrective commands to an automatic stabilization system. The signal also may be telemetered to ground or used to operate a position indicator in the vehicle.

Two horizon sensors are normally installed in a spacecraft, their combined operation being used to correct both pitch and roll.

Machine Reads Script

Handwriting can be read electronically with 90% accuracy, the Symposium on Optical Character Recognition was told recently in Washington, D. C.

L. D. Harmon, Bell Telephone Laboratories, Inc. (Murray Hill, N.J.), described the process this way:

The writer is asked to observe base and guidelines, use no capitals and write legibly. Real-time signals giving stylus position are obtained from a transducer and recorded on magnetic tape, providing input data for a computer-simulated recognition system.

Most of the machine's errors are on the letters M, N, R, U, V and W—the same characters that humans have trouble identifying because of the importance of context.

Meanwhile, electronic reading of typewritten and special characters is continuing to progress rapidly. Farrington Electronics delivered to the Post Office a new experimental mail sorter that reads typed addresses photoelectronically at 9,300 letters an hour. They also announced a contract for a larger and faster machine. The ultimate objective is equipment that will read 36,000 addresses an hour.

"New Color Tube" a Fraud

Tokyo police raided the head office of the Toyo Electric Manufacturing Co., that recently announced and "demonstrated" a sensational new color TV tube supposed to produce colors with layers of gases trapped in silicone grease (RADIO-ELECTRONICS Nov. 1961, page 10). The homes of the former president of the company and an engineer were also raided. The police were apparently searching for evidence that the company had manipulated the market to push up the price of

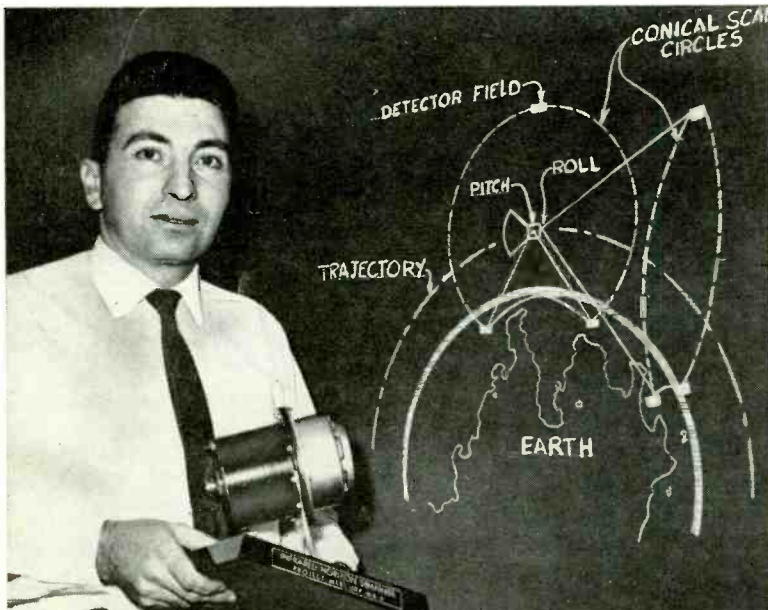

Monty Merlen, the inventor, with "horizon sensor" recovered after Project Mercury mission. Diagram shows how two of them control satellite's pitch and roll.

Advertising Representatives: Los Angeles: Harker-Husted-Coughlin, 408 1/2 South Alvarado St., Tel. DUmkirk 7-2328. San Francisco: Harker-Husted-Coughlin, 444 Market St., Tel. GARfield 1-0151. Atlanta: J. Sidney Crane & Associates, 22 Eighth St. N.E., Tel. TRinity 2-6720. Florida: Neff Associates, 15 Castle Harbor Isle, Fort Lauderdale, Fla. United Kingdom: Publishing & Distributing Co., Ltd., Mitre House, 177 Regent St., London, W. 1, England.

Foreign Agents: Great Britain: Atlas Publishing and Distributing Co., Ltd., 18 Bride Lane, London E.C. 4.

Subscription Service: Address form 3579 and correspondence to Radio-Electronics, Subscriber Service, 154 West 14th St., New York 11, N.Y. When requesting a change of address, please furnish an address label from a recent issue. Allow one month for change of address.

LET DeVRY TECH PREPARE YOU TO

Profit! Prosper!

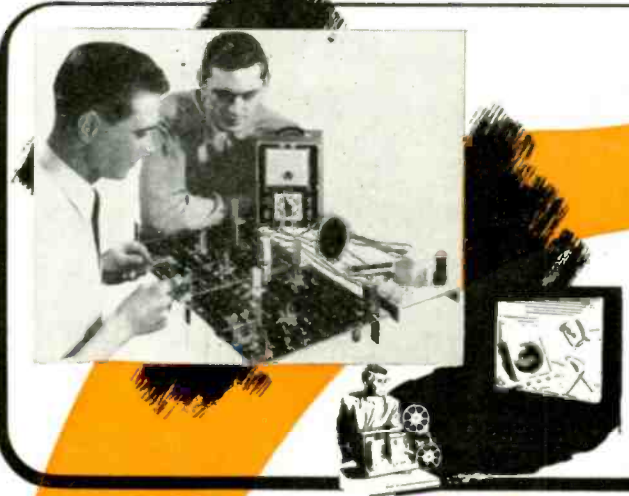

In the Big Job Opportunity Field of Electronics!

DeVRY'S MODERN METHODS HELP YOU LEARN FASTER . . . AT HOME!

**MEN
17 to 55
Eligible**

**NO
ADVANCED
EDUCATION
NEEDED!**

**PREPARE
FOR JOBS
FROM RADIO TO
GUIDED MISSILE
CONTROL**

**NO EXTRA
CHARGE FOR
EFFECTIVE
EMPLOYMENT
SERVICE**

**TIP FOR
MEN WHO FACE
MILITARY SERVICE
—Mail Coupon
today!**

**Prepare
At HOME or
in our CHICAGO
or TORONTO
Laboratories**

DeVry Tech training with its many time-saving features is designed to get you to the big opportunity field of Electronics well trained, in a minimum of time.

Our home training movies save hours of reading, show you electronics "in action," help you to learn faster. DeVry's patented home laboratory system helps you work practical experiments quicker with little soldering to slow you down.

We KNOW the value of good training . . . and understand that a man wants to start in a good job as soon as he can. That's why DeVry Tech provides everything you need to learn quickly at home: up-to-date texts, movie projector, reels of film and 16 shipments of Electronic equipment.

The same holds true in our well-equipped training centers in Chicago and Toronto, where you learn with the help of fine instructors and use modern equipment similar to that you can use later in the industry.

Send coupon for full facts today. Let DeVry Tech help you get ready for a job that pays REAL money. Do it in record time if you wish.

Accredited member of National Home Study Council

SEND FOR 2 FREE BOOKLETS MAIL COUPON TODAY!

DeVRY TECHNICAL INSTITUTE
4141 Belmont Ave, Chicago 41, Ill., Dept. RE-4-5
Please give me your two free booklets, "Pocket Guide to Real Earnings" and "Electronics in Space Travel"; also include details on how to prepare for a career in Electronics. I am interested in the following opportunity fields (check one or more):

- | | |
|---|--|
| <input type="checkbox"/> Guided Missile Control | <input type="checkbox"/> Communications |
| <input type="checkbox"/> Television and Radio | <input type="checkbox"/> Computers |
| <input type="checkbox"/> Microwaves | <input type="checkbox"/> Broadcasting |
| <input type="checkbox"/> Radar | <input type="checkbox"/> Industrial Electronics |
| <input type="checkbox"/> Automation Electronics | <input type="checkbox"/> Special "Short Courses" |

Name _____ Age _____
PLEASE PRINT
 Address _____ Apt. _____
 City _____ Zone _____ State _____
 Check here if you face military service.
 Canadian residents: Write DeVry Tech of Canada, Ltd.,
 2079 970 Lawrence Avenue West, Toronto 19, Ontario

De VRY TECHNICAL INSTITUTE
CHICAGO • TORONTO



STOCK—Hang it on the wall, stand it on a shelf, slip it into your caddy. Cartridge model number is always visible for quick identification.

SAVE—Save money on purchase of any 6 SONOTONE cartridges—save time by always having the right replacements.

SERVICE—You always have the right replacement to service virtually every record player on the market.

SELL—In your shop, an eye-compelling display (unique bonnet fits over 6-Pak to remind your walk-in customers to modernize their record players). In your caddy—a variety of cartridges for nearly every replacement.

Every time you buy 6 SONOTONE cartridges from your distributor, they come in the new attractive 6-Pak cartridge sleeve. You can select any 6 SONOTONE cartridges, or one of three pre-selected 6-Paks which include the most needed cartridges for the most often faced replacement situations.

- **STEREO 6-PAK**—covers nearly every stereo replacement or conversion. Six stereo cartridges from the audiophile's favorite, the 9T, to the budget-priced stereo crystal cartridge, the 12T. Consists of models: 9T, 8T-A, 16T, 18T, 10T and 12T.

- **STEREO/MONO 6-PAK**—covers most stereo or mono replacement needs. Consists of 3 stereo ceramics models 8T-A, 9T, 16T; and 3 mono ceramics; 1P, 2T, 3T.

- **MONOPHONIC 6-PAK**—covers virtually all most called for monophonic replacements. "LB" denotes "less bracket" for slim tonearms. Consists of models; 1P, two 2T's, 2T-LB, 3T-LB.

The 6-Pak is just another way that SONOTONE simplifies your inventory and makes it easier to sell cartridges. Order a SONOTONE 6-Pak today at your parts distributor.

FREE: The new SONOTONE cartridge cross-reference chart catalog is available at your distributor, or write:

SONOTONE® CORPORATION ELMSFORD, NEW YORK
ELECTRONIC APPLICATIONS DIVISION In Canada: Atlas Radio Corp., Ltd. Toronto
Cartridges • Speakers • Tape Heads • Mikes • Electronic Tubes • Batteries • Hearing Aids

their stocks, which soared from 130 yen a share in January 1961 to 505 in July. Technical persons who saw the original demonstration believed it to be a fake product, and that the new set was a Toshiba receiver modified to make it look sufficiently different. The president attacked such statements as slander, but changed his attitude in October and discharged the engineer who, he said, had cheated the company.

Subs to Eavesdrop on Whales

Darts, wired for sound and shot into the back of a baleen whale, may produce electronic data useful to the new Polaris submarines. Each small dart will carry a sound transmitting device. An oceanographic vessel, the Sea Quest, will follow the whale and record electronic data from the sound transmitter in the whale's back.

William V. Kielhorn, Lockheed-California Co.'s oceanographer engaged in anti-submarine warfare research, hopes to learn more about the whale's diving track and underwater habits, as well as build up a "library of sea noises" to prevent sonar recording of false contacts.

The experiment will take place sometime in 1962.

Home TV Tapes

Video tape recorders for home entertainment are being planned by Sony Corp., Tokyo, states Kazuo Iwama, the firm's director of research and development. He is uncertain how soon circuitry can be simplified and production cost reduced enough for large-scale production.

Sony is now improving its transistorized video tape recorder for industrial use, says Mr. Iwama. To date, there are no definite marketing plans for this model.

IRE Meets March 26-29

The 1962 50th Anniversary IRE International Convention is expected to draw more than 70,000 engineers and scientists from 40 countries to the Waldorf-Astoria Hotel and the Coliseum in New York City; dates are March 26 through March 29. A program of 240 papers is being presented in 54 sessions. The IRE Electronics Show held in conjunction with the convention includes 850 exhibitors and some \$15,000,000 worth of electronic equipment.

ETV To Pay Own Way

Airborne educational television has been operating regularly since Sept. 11, with regular instruction for students from the first grade to college levels. Up to the present, it has been experimental, with costs shared among various sponsors. Now a plan has been announced by Dr. John E. Ivey, Jr., former University of Michigan administrator, which would put the new Midwest Program

(Continued on page 12)

Free

ALLIED 1962 ELECTRONICS CATALOG 444 PAGES! WORLD'S BIGGEST—MOST COMPLETE

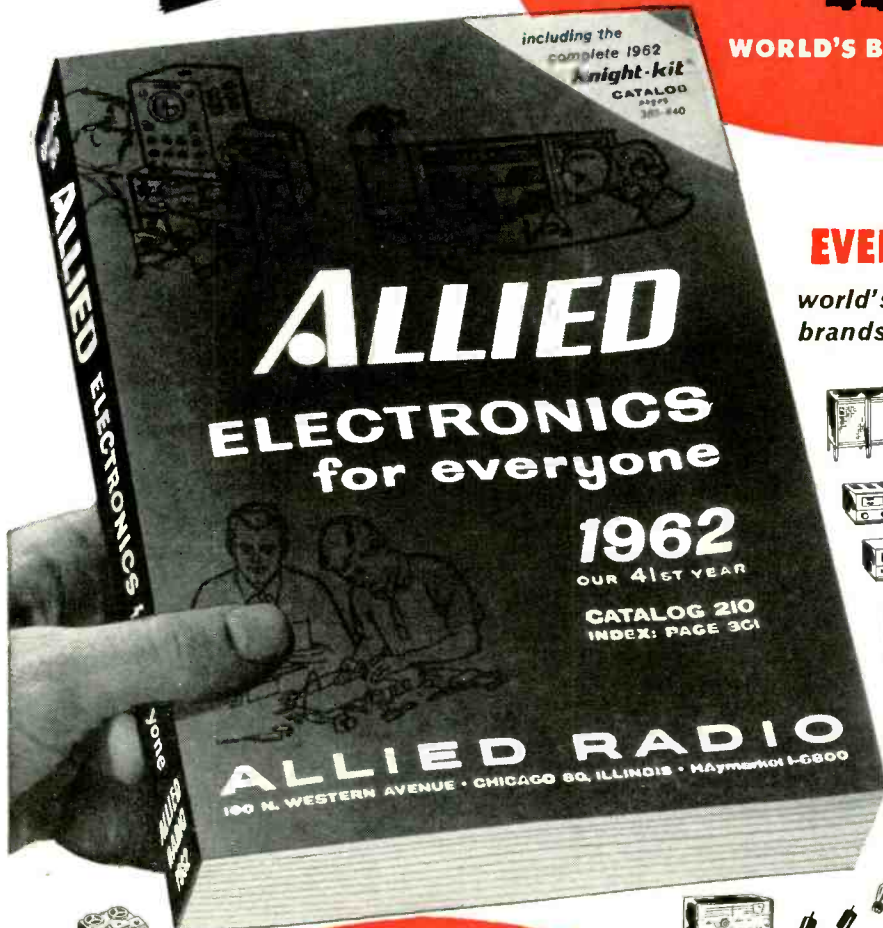

SAVE MOST ON

EVERYTHING IN ELECTRONICS

world's largest selection of famous-name brands, plus exclusive products & values

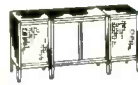

- New Multiplex Stereo FM—All-Transistor Stereo Hi-Fi
- New Stereo Hi-Fi Systems—Everything in Hi-Fi Components
- Money-Saving Build-Your-Own KNIGHT-KITS® for Every Need
- Best Buys in Tape Recorders, Tape and Recording Supplies
- Citizens Band 2-Way Radios
- Amateur Receivers, Transmitters, and Station Gear
- Public Address Systems, Paging and Intercom Equipment
- Test and Laboratory Instruments
- TV Tubes, Antennas, Accessories
- Batteries, Wire, Tools, Hardware
- Huge Listings of Parts, Tubes, Transistors, Technical Books



**NEW Multiplex Stereo FM
All-Transistor Stereo Hi-Fi**

NO MONEY DOWN
on Allied's new Credit Fund Plan
Now—enjoy 50% more buying power—up to 24 months to pay—see our 1962 Catalog for simple details.

ALLIED exclusives:

MONEY-SAVING KNIGHT-KITS®. Enjoy the most satisfying do-it-yourself experience in the world! Build KNIGHT-KITS—lowest in cost, easiest to assemble, best for performance. Select from over 90 exciting KNIGHT-KITS—Stereo, Hi-Fi, Hobbyist, Amateur and Test Instruments. An exclusive ALLIED product.

BEST-BUY KNIGHT® PRODUCTS. Save most on famous KNIGHT Stereo Hi-Fi—comparable to the best in quality, styling, performance—yet priced far lower. Select super-value KNIGHT components or complete systems (including latest Multiplex Stereo and All-Transistor Hi-Fi). KNIGHT products are acclaimed by all who recognize integrity in design and manufacture and who appreciate value.

ALLIED RADIO

World's Largest Electronic Supply House

Satisfaction Guaranteed or Your Money Back

- World's Largest Stocks • Lowest Money-Saving Prices
- Fastest Shipment • Expert Personal Service

send today for the world's biggest electronics catalog!



ALLIED RADIO, Dept. 2-D2
100 N. Western Ave., Chicago 80, Ill.

Send FREE 1962 ALLIED 444-page Catalog

Name _____
PLEASE PRINT

Address _____

City _____ Zone _____ State _____



50,000,000 tube hours... an unusual electron tube still keeps undersea voice signals strong

Deep on ocean floors, from North America to Europe, between Key West and Havana, Florida and Puerto Rico, under the Pacific to Hawaii and Alaska—in 20,000 miles of undersea telephone cable—a special kind of electron tube is setting a remarkable record for reliability.

This four-inch-long electron tube was designed, developed and fabricated at Bell Telephone Laboratories to operate with no attention for 20 years or more. It is part of the submarine cable repeater manufactured by Western Electric which faithfully and reliably amplifies voice signals transmitted along undersea coaxial cables.

All of the 1608 tubes built into the repeaters have operated to date without failure for a total of over 50,000,000 tube hours, or an average of three-and-a-half years. The oldest have been in service since the first deep-sea repeatered telephone cable was laid 12 years ago.

Years before it was put to use, Bell Laboratories scientists and engineers began developing this undersea tube, another example of forward-looking technology that has made the Bell Telephone Laboratories the world center of communications research and development.



BELL TELEPHONE LABORATORIES

how to get a Commercial FCC LICENSE

An FCC License, Or Your Money Back!

Completion of the Master Course (both Sections) will prepare you for a First Class Commercial Radio Telephone License with a Radar Endorsement. Should you fail to pass the FCC examination for this license after successfully completing the Master Course, you will receive a full refund of all tuition payments. This guarantee is valid for the entire period of your enrollment agreement.

FREE!

find out how . . .

1. You can get job security. Specialized education is the road to higher salary and important jobs in the growing field of electronics.
2. You can solve the problems that stump other technicians. Problems in electronics are becoming more complex. Your ability to solve problems will help you get ahead in your field.
3. You can handle new electronic devices. Every day, advances are being made in electronics. Only through education can you find out how to keep up with these developments and how to use the new devices.

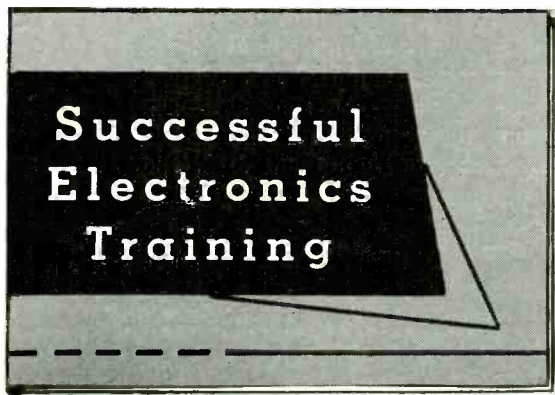

Increase Your Technical Knowledge

Get a government license plus an understanding of such electronic applications as computers . . . industrial electronics . . . radar . . . communications . . . and many more

CLEVELAND INSTITUTE OF ELECTRONICS

1776 E. 17th St. Desk RE64A, Cleveland 14, Ohio

APRIL, 1962

Mail Coupon NOW!



good training
doesn't cost . . .
it pays!

Get All 3 Booklets and This Handy Pocket Electronics Data Guide **Free**

Puts all the commonly used conversion factors, formulas, tables, and color codes at your fingertips. Yours absolutely free if you mail the coupon today. No further obligation.

Sorry—Not For Beginners

Please inquire only if you really want to get ahead and to add to what you have already learned in school, in the service, or on the job. Some previous schooling or experience in electronics, electricity, or related fields is necessary for success in Cleveland Institute programs.

Accredited by the National Home Study Council

Cleveland Institute of Electronics

Desk RE64A, 1776 E. 17th St., Cleveland 14, Ohio



Please send Free Career Information prepared to help me get ahead in Electronics. I have had training or experience in Electronics as indicated below.

- | | |
|---|---|
| <input type="checkbox"/> Military | <input type="checkbox"/> Broadcasting |
| <input type="checkbox"/> Radio-TV Servicing | <input type="checkbox"/> Home Experimenting |
| <input type="checkbox"/> Manufacturing | <input type="checkbox"/> Telephone Company |
| <input type="checkbox"/> Amateur Radio | <input type="checkbox"/> Other _____ |

In what kind of work are you now engaged?

In what branch of Electronics are you interested?

Name _____ Age _____

Address _____

City _____ Zone _____ State _____

RE64A

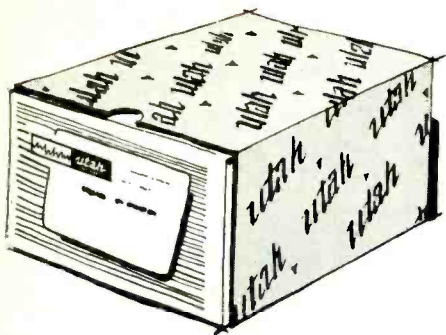

WHY PACK ONLY ONE SPEAKER TO A BOX?

A speaker is a delicate precision-built instrument which should be protected from dust and physical abuse.

By single-packing speakers in custom-fitted reshippable cartons, Utah actually saves the distributor time and money. There's no need for repacking. Clearly labeled, single-packed speakers make inventory control easy for both the distributor and serviceman.

Most important, Utah can guarantee factory tested performance of every speaker on delivery. This adds up to customer satisfaction all down the line.

Utah believes everyone benefits from single-packing—consumer, serviceman, distributor—and the electronics industry.



HUNTINGTON, INDIANA

(Continued from page 8)
on Airborne Television Instruction (MPATI) on a pay-as-you-go basis.

Under Dr. Ivey's plan, fees from participating schools would be pooled to build up an annual budget of a little less than \$4,000,000. The basic rate would be \$1 per pupil, with a minimum charge of \$200 for a participating school, and a reduction for schools with enrollments above 1,000. If put on a self-supporting basis, Dr. Ivey says, the system could be expanded by 1965 to cover an area of 172,000 square miles with a potential enrollment of 9,400,000 students.

Ruby Maser Works Continuously

The first solid-state optical maser to operate continuously has been announced by Bell Laboratories. A radical new way of exciting the maser crystal delivers five times the intensity that has been possible from previous continuous optical maser

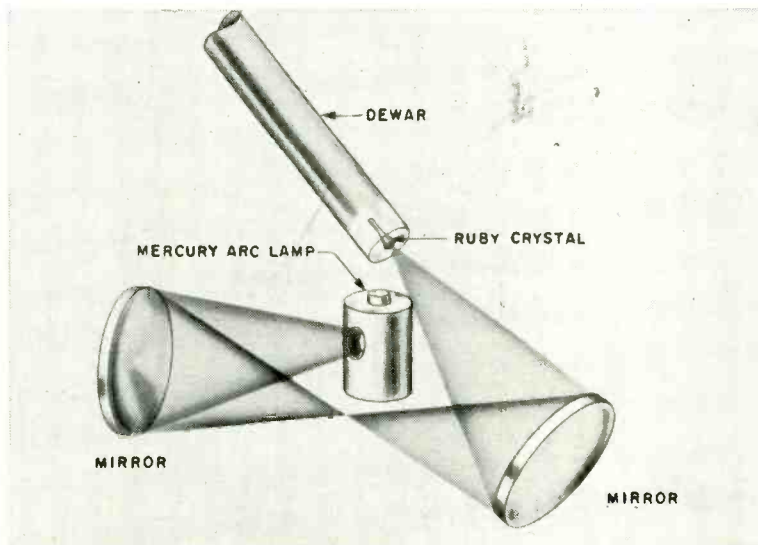

pumps. Instead of using a spiral xenon flash lamp, a mercury arc lamp is used, with a pair of concave spherical mirrors, to focus practically the whole of the light onto the face of the maser crystal. This reduces the power requirements from the more than 1,000 kw originally needed for pulsed operation to less than 1 kw for continuous operation.

Co-eds Enter Electronics

Young women college graduates this spring will find more jobs to choose from than did their sisters last year, according to a recent *Wall Street Journal* survey, and the barriers are more likely to be down in the electronics field than in others.

Litton Industries states: "We are stepping up our recruiting of women, especially those with electronic engineering and physics degrees. When we find a woman in one of those fields, we snap her up." Raytheon plans to hire about 10 scientifically oriented girls this year, compared with only 3 last year, and would hire more, excepting that the colleges "just don't have many girls

who specialize in the fields we are interested in."

There is a tendency to feel that women are better suited than men for some finicky lab jobs. "Women are more patient and painstaking," according to one research lab head.

University spokesmen agree that women's greatest opportunities lie in the engineering, math and science fields. Mildred Webber, placement official at the University of Michigan, maintains that "women have just as good a chance as men in any science field, and can earn comparable salaries."

CBS Backs All-Channel TV

CBS President Frank Stanton pledged the network's full support to the Federal Communications Commission's drive toward vhf-uhf TV sets, at the FCC's Washington hearings on TV programming. Dr. Stanton said "... We support the FCC in its effort to persuade the Congress

to enact legislation which would result in the manufacture of only all-channel receivers."

The statement made CBS the first major network to officially take this position.

The switch to all-channel TV would provide 80 channels instead of the 12 now found on vhf receivers.

Sniperscope Has New Use

A Navy infrared sniperscope promises to aid doctors in diagnosing and treating blindness of certain types, according to the *Naval Research Reviews*. When the cornea (transparent part of the outer covering of the eyeball) becomes opaque, the patient not only cannot see out, but the examining doctor cannot see the condition of the structures in the eye. By placing the sniperscope between the observer and the regular ophthalmic instrument used for examination, the observer can see what is not visible with ordinary light, since infrared penetrates many tissues that are quite opaque to the rest of the spectrum. There is a further

(Continued on page 16)

The Same School That Originated The RTS BUSINESS PLAN

...NOW
Proudly
Presents...

A SPECIAL COMPACT COURSE COVERING ALL THREE PHASES OF **ELECTRONICS**

The Entire Course Is Made Up Of The Following:

- 35 LESSONS COVERING BASIC AND INTERMEDIATE ELECTRONICS
- 9 EQUIPMENT KITS COMPLETE WITH TUBES AND BATTERIES
- SOLDERING IRON
- 25 LESSONS COVERING THESE ADVANCED ELECTRONIC SUBJECTS:
 - Thyratron Tubes • Semiconductors • Electronic Symbols and Drawings • Voltage-Regulators • Electronic-Timers • Control Systems • X-Rays • Photoelectric Devices • Dielectric Heating • Geiger Counters • Pulse Circuitry • Clippers and Limiters • Multivibrators • Electronic Counters • Radar • Magnetic Amplifiers • Analog-Computers • DC Amplifiers • Digital Computers • Storage Systems • Input and Output Devices • Servomechanisms • Telemetering
- 60 EXAMINATIONS
- UNLIMITED CONSULTATION SERVICE
- KIT MANUALS
- DIPLOMA UPON GRADUATION

**BASIC • INTERMEDIATE • ADVANCED
DESIGNED FOR THE BUSY MAN OF TODAY**

This is MODERN training for the MODERN man. You'll find no "horse and buggy" methods here. Every page of this streamlined course is devoted to important Electronics principles and practical projects. You'll be amazed how fast you grasp Electronics the RTS way. RTS has combined modern THEORY and PRACTICE to make this the finest training program of its kind available!

SATISFIES NOVICE, TECHNICIAN OR HOBBYIST

Whether you're new to Electronics or an old "pro," chances are you'll find this to be the ideal course for you. The novice will appreciate the completeness of the training. It starts with the most basic considerations, covering each important point thoroughly, yet concisely. The technician will enjoy the practical review of fundamentals and profit from the 25 advanced subjects covered.

RTS GIVES YOU "TOP MILEAGE" FOR YOUR TRAINING DOLLAR

The price quoted below buys EVERYTHING — there are no extras to pay for. RTS has gone "all out" to give you the best training value in America. Why pay hundreds of dollars for training such as we offer when it's available for this LOW PRICE? If you can find a better training bargain... BUY IT!

CAN BE COMPLETED IN MONTHS INSTEAD OF YEARS

Some students will complete this course with "Jet-Like" speed but we allow up to two years if your circumstances require it. You study at your own rate. You are ENCOURAGED but not pushed. You'll find the lessons professionally written but easy to understand. LET US SEND YOU ONE OF THESE LESSONS ALONG WITH YOUR CAREER BOOKLET SO YOU CAN SEE FOR YOURSELF. NO OBLIGATION!

AND MUCH MORE...

RTS' Membership in The Association of Home Study Schools is your assurance of Reliability, Integrity and Quality of Training.

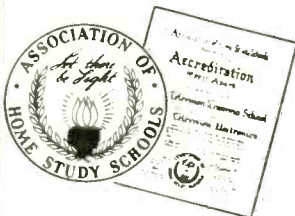

RTS ELECTRONICS DIVISION
815 E. ROSECRANS AVENUE
LOS ANGELES 59, CALIFORNIA

Est. 1922



L 2018

COMPLETE
COST...
INCLUDES ALL KITS,
TUBES, BATTERIES, ETC.
\$125.00*

**Rush
Coupon**

**NO
SALESMAN
WILL
CALL!**

* TERMS ALSO AVAILABLE
AS LITTLE AS

\$5⁰⁰ DOWN \$5⁰⁰ PER MONTH

**SAVE TIME — SEND
\$5.00 WITH COUPON**

**YOUR FIRST LESSONS AND
KIT WILL BE RUSHED TO YOU
THE SAME DAY THEY ARE RECEIVED!**

DON'T LOSE OUT — FIND OUT!

RTS ELECTRONICS DIVISION, Dept. RE-42
815 E. ROSECRANS AVENUE LOS ANGELES 59, CALIFORNIA

Rush me full information by return mail. (Please Print)

Name _____ Age _____

Address _____

City _____ Zone _____ State _____

ENROLL ME NOW **SEND MORE FACTS**

**MORE SERVICEMEN
USE CLAROSTAT
WIRE-WOUND CONTROLS
THAN ALL OTHERS
COMBINED BECAUSE...**



It's a fact . . . More Clarostat wire-wound controls are used by servicemen than all others combined! For over forty years the built-in quality of Clarostat wire-wound controls has proved itself to the satisfaction of servicemen and their customers alike.

Join the crowd. When you need a wire-wound control replacement, insist on Clarostat in the green box—your assurance that you're getting the control that works best.

**QUALITY
COMES
FIRST
WITH**

- ★ Series A43 and A43S 2-watt controls. With or without switch. Pick-A-Shaft convenience.
- ★ Series A58 and A58S 3-watt controls. With or without switch. Pick-A-Shaft convenience.
- ★ Series A10 and A10S 4-watt controls. With or without switch. Pick-A-Shaft convenience.
- ★ Series 39 2-watt "Humdinger" for screwdriver adjustment.

DISTRIBUTOR SALES DIVISION



CLAROSTAT

CLAROSTAT MFG. CO., INC. DOVER, NEW HAMPSHIRE

UPGRADE YOUR INCOME

through Grantham Training

Get
Your First Class Commercial
F.C.C. LICENSE
QUICKLY!

WHICH COURSE TO TAKE?

HERE ARE FIVE RULES to guide you
in selecting the course of training that is best suited to
YOUR PERSONAL NEEDS:

- ✓ IT MUST teach you *the theory of electronics*. WHAT good is a course if it doesn't really "MAKE ELECTRONICS YOURS," to use for your personal advancement? Select a course *that you can understand*... one that reveals to you the basic, underlying principles of electronics.
- ✓ IT MUST be one that can be completed successfully in a matter of WEEKS, not a course that goes *on and on!* Time is worth money. Every extra week which a "long course" may require is *money out of your pocket!* It costs more than tuition... it costs you real dollars! Let nothing delay YOU in preparing for your FCC license. Select a school that values YOUR TIME!
- ✓ IT MUST be *reasonable* in cost! The best test of the *true worth* of a product or service is in WHAT YOU GET FOR YOUR MONEY. Select a course that is sufficiently reasonable in cost *so that you know you won't have to drop out before you complete it!* Select a school with conservative tuition fees — but, *be sure it does something for you.*
- ✓ IT MUST gain recognition for you. Don't be satisfied with the mere promise of some sort of *diploma!* Be sure the course will qualify you for a nationally recognized measure of electronics knowledge — a **FIRST CLASS Commercial FCC License**. Remember: This is a U.S. Government license. No school can issue it, nor *promise it* to you! Select a school whose graduates consistently **PASS** the FCC exams.
- ✓ IT MUST be a mature course of training... for mature men... not a mere "memory" course or one in which you are expected to cram your way through by "brute force." IT MUST not be one that leaves you "on your own." Select a school that affords you personalized instruction. Select a course from a school that reflects maturity, dignity, and integrity.

Grantham Schools

LOS ANGELES • SEATTLE • KANSAS CITY • WASHINGTON
CORRESPONDENCE OR RESIDENCE CLASSES

Grantham training is available by correspondence or in resident classes. Either way, you are trained quickly and well. Write, or mail the coupon for details.

ACCREDITED BY THE NATIONAL HOME STUDY COUNCIL

APRIL, 1962

YOUR TIME

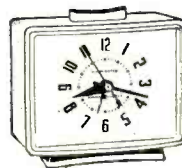

IS
WORTH



MONEY!

IS GRANTHAM TRAINING FOR YOU?

HERE ARE FIVE FEATURES OF GRANTHAM TRAINING
... check them off ... see if this is the course for you.

CHECK THESE FEATURES:

- Grantham teaches the *theory* of electronics. Every basic concept of electronics fundamentals is covered in the Grantham course... whether you take it in resident classes or by home study. Grantham training "*makes electronics yours.*"
- You can get your First Class FCC license **IN ONLY 12 WEEKS** in Grantham resident classes (or, in a correspondingly short time in the Grantham home-study program). **THINK OF IT!** A *commercial* U.S. Government license... **PROOF OF YOUR** qualifications in meeting these U.S. Government requirements as an electronics communications technician... a nationally recognized certificate. By preparing you for this license in only 12 WEEKS, Grantham conserves **YOUR TIME!**
- Grantham Schools' tuition rates are low, yet the instructional service is not equalled by many of the *most expensive schools!* Grantham can do this because of highly efficient instructional methods and because Grantham has a sincere desire to out-do all others in service rendered per tuition-dollar. Grantham has established *reasonable* tuition rates. And, the percentage of students who successfully complete the Grantham course — and who get their FCC licenses — is one of the highest in the nation.
- YOU GAIN RESPECT** by showing your Grantham diploma, once you earn it. **YOU GAIN RESPECT** by showing and posting your First Class FCC License — a nationally recognized certification of your electronics knowledge. Many companies which employ industrial electronics technicians require them to have this license. **YOU CAN GET IT IN ONLY 12 WEEKS.** Let Grantham show you how!
- Mature men select Grantham Schools for electronics training. (The average age of Grantham Students is 28.8 years.) **MATURE MEN** want a definite objective (not a pot of gold at the end of the rainbow). Grantham training has this specific objective: To prepare you for your First Class FCC license and greater earning capability. The Grantham Course is for mature men *who know what they want.*

TO: GRANTHAM SCHOOLS, INC.

NATIONAL HEADQUARTERS OFFICE
1505 N. Western Ave., Hollywood 27, Calif.

24-D

Please send me full details on the course indicated below.
I understand that there is no obligation and no salesman will call.

NAME _____ AGE _____

ADDRESS _____

CITY _____ STATE _____

I am interested in: Home Study Resident Classes

AEROVOX CERAMIC CAPACITORS

PRODUCT
NEWS
FROM



provide the complete line of proven top-quality types for your industrial requirements

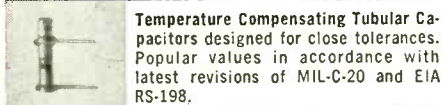

Temperature Compensating Tubular Capacitors designed for close tolerances. Popular values in accordance with latest revisions of MIL-C-20 and EIA RS-198.

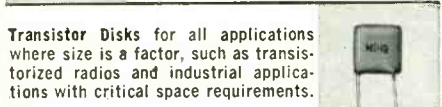

Transistor Disks for all applications where size is a factor, such as transistorized radios and industrial applications with critical space requirements.

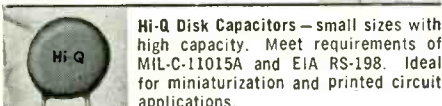

Hi-Q Disk Capacitors—small sizes with high capacity. Meet requirements of MIL-C-11015A and EIA RS-198. Ideal for miniaturization and printed circuit applications.

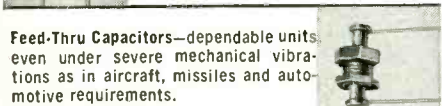

Feed-Thru Capacitors—dependable units, even under severe mechanical vibrations as in aircraft, missiles and automotive requirements.



Disk Stand-Off Capacitors for industrial applications with critical space requirements. • **Eyelet Feed-Thru Capacitors** featuring a unique design for high frequency bypass.

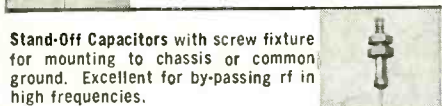

Stand-Off Capacitors with screw fixture for mounting to chassis or common ground. Excellent for by-passing rf in high frequencies.



Hi-Q Plate Assemblies—rugged combinations of resistor-capacitor networks in all sizes and values.

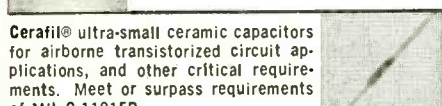

Cerafil® ultra-small ceramic capacitors for airborne transistorized circuit applications, and other critical requirements. Meet or surpass requirements of MIL-C-11015B.

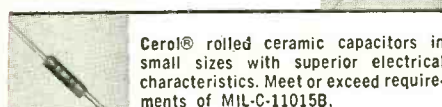

Cero® rolled ceramic capacitors in small sizes with superior electrical characteristics. Meet or exceed requirements of MIL-C-11015B.



Hi Voltage Cartwheels—provide dependable service while withstanding high voltage. Universal type for filter and bypass applications.

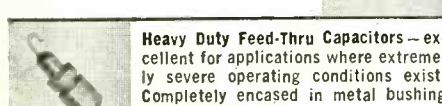

Heavy Duty Feed-Thru Capacitors—excellent for applications where extremely severe operating conditions exist. Completely encased in metal bushing with phenolic seal.



AEROVOX CORPORATION

DISTRIBUTOR DIVISION

NEW BEDFORD, MASS.

Technical Leadership - Manufacturing Excellence

Ask your Aerovox Industrial Distributor for a copy of Aerovox Industrial Catalog IDC-561.



The Fort Dix Advent antenna as it approached completion.

(Continued from page 12)

advantage if infrared light only is applied to the patient, his pupil dilates as if in total darkness, giving the doctor further opportunities for observation.

Calendar of Events

IHFH High Fidelity Show, Mar. 20-25, Ambassador Hotel, Los Angeles, Calif.

IRE International Convention, Mar. 26-29, Coliseum, New York, N. Y.

Southwest IRE Conference and Electronics Show, April 11-13, Rice Hotel, Houston, Tex.

IRE-AIEE Symposium on Mathematical Theory of Automata, April 24-26, United Engineering Center, New York, N. Y.

SMPTE 91st Convention, April 29-May 4, Ambassador Hotel, Los Angeles, Calif.

IRE, AIEE Spring Joint Computer Conference, May 1-3, Fairmont Hotel, San Francisco, Calif.

IRE International Congress on Human Factors in Electronics, May 3-4, Lafayette Hotel, Long Beach, Calif.

IRE, AIEE, EIA Electronic Components Conference, May 8-10, Marriott Twin Bridges Hotel, Washington, D. C.

IRE National Aerospace Electronics Conference, May 14-16, Biltmore Hotel, Dayton, Ohio.

Institute for Advancement of Medical Communication Council on Medical TV, May 15-16, National Institutes of Health, Bethesda, Md.

Navy Medical Dental TV Workshop, May 16-17, National Naval Medical Center, Bethesda, Md.

1962 Electronic Parts Distributors Show, May 21-24, Conrad Hilton Hotel, Chicago. Attendance limited to manufacturers, distributors, representatives and their advertising agencies.

RADIO-ELECTRONICS will exhibit in Room 610.

ISA National Aero-space Instrumentation Symposium, May 21-23, Marriott Twin Bridges, Motor Hotel, Washington, D. C.

IRE, AIEE, ASME, ISA National Telemetry Conference, May 23-25, Sheraton Park Hotel, Washington, D. C.

EIA Annual Convention, May 23-25, Pick-Congress Hotel, Chicago, Ill.

IRE Seventh Region Space Communications Conference, May 24-26, Seattle, Wash.

Advent Antenna Up

World's most accurate space communications antenna has been installed at the Project Advent ground station at Fort Dix, N. J. The 60-foot parabolic reflector weighs 9 tons. Standing 102 feet overall, the an-

tenna will track and will handle vital communications with military Advent satellites. (Project Advent is a Department of Defense research and development program to determine the feasibility of a reliable military communications system for relaying messages anywhere in the world through active-repeater satellites hovering in a 22,300-mile-high stationary orbit above the equator.)

Brief Briefs

The first completely solid-state microwave communications equipment, according to the Radio Corporation of America, was demonstrated to Pennsylvania Electric Association members, who held conversations over the laboratory equivalent of a 60-mile microwave system, with what was described as "excellent results". The new equipment is crystal-controlled and operates with transistors and varactor diodes.

The term "compactron" is now a standard English word. The General Electric Co. has taken steps to abandon its trademark on the word as applied to multi-function electronic devices developed by the company.

The single-gun Chromatron color tube will be manufactured by Sony Corp. in Japan, under a license agreement with the American patent owners. Sony states that it believes the one-gun Chromatron has inherent properties that will enable Sony to make a color TV set that will be "brighter, less bulky, have less service problems, and cost less than current sets."

A 3-megawatt laser has been announced by the U. S. Army Signal Research and Development Lab, Fort Monmouth, N. J. This is 300 times as powerful as lasers in general laboratory use.

END

are you standing still in electronics while this man advances?

Find out why—and do something about it—if you have the ambition to want a career instead of just a job.

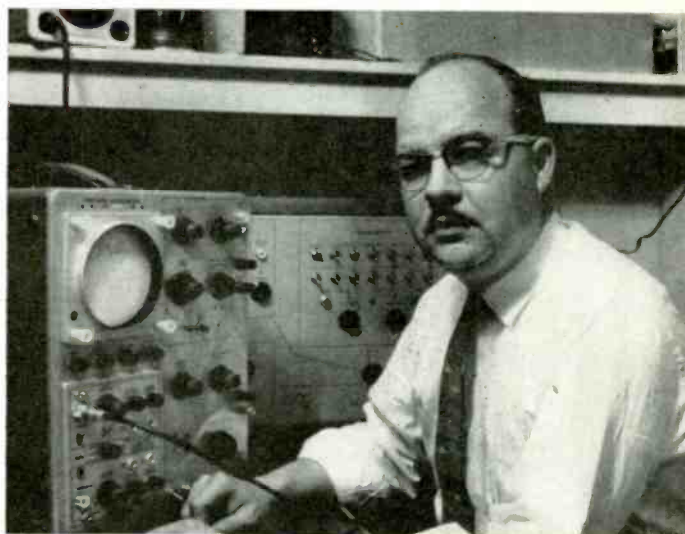

CREI graduate Mearl Martin, Jr. has progressed from Junior Technician to licensed Senior Engineer. He is now Field Support Manager, Marketing Division of Tektronix, Inc., Portland, Oregon.

LET'S LOOK AT THE FACTS. There's something wonderful about knowing how a circuit works or what a filter capacitor does. If you've ever fixed a TV set, built a radio or used a voltmeter, you've tasted the thrills of electronics.

This excitement may have led you to a job in electronics. But the glamour fades if you are stuck in the same job year after year. You'll be bored with routine and unhappy about prospects for future earnings. You'll discover, as have many men, that simply working in electronics does not assure a good future.

If electronics is the "field of opportunity," how is this possible? No question about it, electronics offers many opportunities, but only to qualified men. In any career field, it is how much you know that counts. This is particularly true in the fast moving field of electronics. The man without thorough technical education doesn't advance. Even men with intensive military technical training find their careers can be limited in civilian electronics.

ADVANCED TECHNICAL KNOWLEDGE IS THE KEY to success in electronics. If you have a practical knowledge of current engineering developments, if you understand "why" as well as "how," you have what employers want and pay for. With such qualifications, you can expect to move ahead.

CREI OFFERS YOU, for study at home, a complete program in electronic engineering technology designed to prepare you for a rewarding, well-paying career in electronics. CREI equips you with a practical working knowledge of advanced and up-to-date electronic developments that will put you on the level of specialization where men are most in demand.

CREI MEN LIKE MEARL MARTIN, JR. hold positions as associate engineers, engineering aides, field engineers, project engineers and technical representatives.

WHEN YOU ENROLL IN A CREI HOME STUDY PROGRAM, you study courses to which a number of today's leading engineers and scientists have made substantial contributions. You are guided and assisted by CREI's staff

of experienced instructors. You study texts that are specifically prepared for home study use.

Through CREI, you have a choice of programs covering every field of electronics:

RADAR • COMPUTERS • SERVOMECHANISMS • INSTRUMENTATION • AERONAUTICAL AND NAVIGATIONAL • COMMUNICATIONS • TELEVISION • AUTOMATION AND INDUSTRIAL ENGINEERING TECHNOLOGY • NUCLEAR ENGINEERING TECHNOLOGY

Programs are available for men, such as engineers, who already have extensive technical knowledge, as well as for men with limited technical training or experience.

THE HIGH CALIBRE OF A CREI HOME STUDY EDUCATION is attested to by America's biggest corporations, where CREI students and alumni attain positions ranging from engineering technicians to engineers to top officials. Such companies are National Broadcasting Company, Pan American Airways, Federal Electric Corporation, The Martin Company, Northwest Tele-

phone Company, Mackay Radio, Florida Power and Light and many others. They not only recognize CREI Home Study educational qualifications but often pay all or part of CREI tuition for their employees.

CREI HOME STUDY PROGRAMS are the product of 35 years of experience. Each program has been developed with the same painstaking skill and care that CREI put into its electronics courses for the Army Signal Corps, its special radio technician courses for the Navy, and its group training programs for leading aviation and electronics companies. For those who can attend classes in person, CREI maintains a Residence School in Washington, D. C.

YOU CAN QUALIFY for a CREI Program, if you have basic knowledge of radio or electronics and are a high school graduate or the equivalent. If you meet these qualifications, write for **FREE 58-page book** describing CREI Programs and career opportunities in advanced electronic engineering technology. Use coupon below, or write to: The Capitol Radio Engineering Institute, Dept. 1404-K, 3224 Sixteenth St., N. W., Washington 10, D. C.

Mail coupon today for **FREE 58-page book**

THE CAPITOL RADIO ENGINEERING INSTITUTE

Founded 1927

Dept. 1404-K, 3224 Sixteenth St., N.W., Washington 10, D.C.

Please send me details of CREI Home Study Programs and Free Book, "Your Future in Electronics and Nuclear Engineering Technology." My qualifications are noted to obtain immediate service.

CHECK Electronic Engineering Technology Nuclear Engineering Technology
FIELD OF Servo and Computer Engineering Automation and Industrial Electronic Engineering Technology
GREATEST Technology
INTEREST: Aero and Navigational Engineering Technology

Name _____ Age _____

Address _____

City _____ Zone _____ State _____

Employed by _____

Type of present work _____

Education: Years High School _____ Other _____

Electronics Experience _____

Check: Home Study Residence School G.I. Bill

26



TVL TWIST-LOK® CAPACITORS

These 'lytics take on the toughest TV and radio duty, give maximum trouble-free service, *without HUMMM!* They are dependable at extremely high and low temperatures. Cathodes are etched to meet the needs of high ripple currents, high surge voltages.

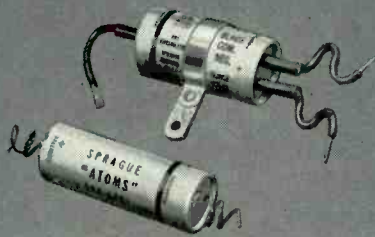

TVA ATOM® CAPACITORS

Atom tubulars are service favorites because they fit anywhere, work anywhere. They're the *only* small size 85 C (185 F) capacitors in ratings up to 450 WVDC. They have low leakage current, long shelf life, and withstand high ripple currents, high surge voltages.



TE LITTL-LYTIC® CAPACITORS

The very best ultra-miniature replacements for transistor circuits, offering unusual reliability through all-welded construction. No pressure joints to cause "open" or intermittent circuits. Long shelf life—extremely important in sets used only part of the year.



VL VERTI-LYTIC* CAPACITORS

These single-ended molded tubulars are the ideal replacement for units of this type found on printed wiring boards. Keyed terminals assure fast manual mounting and correct polarity. Resin end fill protects against drying of electrolyte or entrance of external moisture.



PCL PRINT-LOK® CAPACITORS

The printed circuit version of the Twist-Lok. Universal base replaces any of the printed circuit 'lytics in use today. No makeshift mounting adapters to damage capacitor or add extra height . . . no possibility of high resistance contacts.

EVERY 'LYTIC YOU NEED...

- every value
- every rating
- every style

Shown here are the more popular of Sprague's big family of Electrolytic Capacitors, the broadest in the industry. Other types include Metal-encased Screwbase; Plastic-encased High-MF; Metal-encased Octal-base; Ultra-low leakage Photoflash. All are listed and described in Sprague's NEW Catalog C-614. Get your copy from any Sprague distributor, or write Sprague Products Company, 81 Marshall Street, North Adams, Massachusetts.

*TRADEMARK

SPRAGUE®
THE MARK OF RELIABILITY

WORLD'S LARGEST CAPACITOR MANUFACTURER

exclusive in PHOTOFACT

the world's finest electronic service data

famous Howard W. Sams **CIRCUITRACE**® and **SERVICING AIDS**!

handiest, most-complete data ever published to speed and simplify servicing—
equally useful for troubleshooting in the home or on the bench...

CIRCUITRACE®

exclusive Sams standardized, uniform system for fastest, easiest printed board troubleshooting...

Here's how CircuitTrace works: All test points are clearly shown on the schematic and each is plainly coded (see illustration at left). The same test points are similarly coded on the printed board photo (see illustration at right) so you instantly know where to make your

measurement! No more costly hunting for test points...no more guesswork...no need to look at both sides of the board—identifies tubes, transistors, and foil connections of parts throughout circuits. CircuitTrace makes printed board servicing a breeze!

TIME-SAVING SERVICE AIDS for field or shop

FIELD SERVICING NOTES

SAFETY GLASS REMOVAL (MODEL KC366)

Remove 4 screws holding the trim strip at the top of the safety glass. Tilt glass out and remove.

FUSE AND FUSE DEVICE

TV: Sweep - 1/2 Amp. (M1) Radi
LV Supply - Fuse Wire (M2)
Filament - Fuse Wire
See "Tube..."

Valuable instructions for making all necessary adjustments in the home, locating fuses, removing safety glass, etc.

TUBE PLACEMENT CHARTS

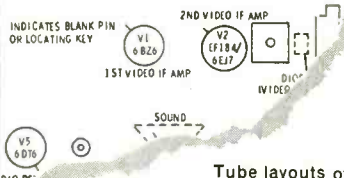

Tube layouts of top and bottom of chassis show sync and sound paths, tube keyways, fuses, rectifiers, etc. Helps you trace signal path to localize the trouble.

TUBE FAILURE CHECK CHART

POWER SUPPLY FAILURE

No raster, no sound Fuse Wire (LV Power), Fuse V

SWEEP FAILURE

No raster, has sound Fuse (Sweep), V8, V9, V10,
No vertical deflection V7
Poor vert. linearity or foldover V7
Poor horiz. linearity or foldover
Narrow picture V8, V9, V10
Vert...

Points out probable causes of common troubles, tells you which tubes to replace to correct the symptom. Also shows series-string filament connections.

DISASSEMBLY INSTRUCTIONS

TV CHASSIS REMOVAL

1. Remove 10 push-on type knobs
2. Remove 12 wood screws in

You get step-by-step procedure for removing chassis, CRT, speakers, knobs, hidden bolts and connections. Avoids parts damage—saves valuable time.

HORIZONTAL SWEEP CIRCUIT ADJUSTMENTS

Set the Horizontal Hold Control to Horizontal Frequency Slug (B1) tally. Keep turning B1 in the out of sync. Reverse t

Detailed instructions help you solve the troublesome problem of adjusting the horizontal circuits (oscillator, linearity, and width)—avoids guesswork!

These are just a few of the dozens of great features in PHOTOFACT for fastest, easiest, most profitable servicing. See your Sams Distributor for full details on an Easy Buy Library or Standing Order subscription!

Are You Enjoying the Benefits of Membership in "PEET"?

Join the thousands who have qualified and profited by membership in the "PEET" Program. If you now own a PHOTOFACT Library or plan to own one, you can apply for membership. It's the *only* program designed to build powerful public acceptance for you, which means increased business and profits. You get dozens of free promotional aids. Benefits cost you absolutely nothing if you qualify. Ask your Sams Distributor for the "PEET" details or mail coupon today.



Powerful national advertising monthly in TV Guide now carries the "PEET" message to over 8,000,000 TV families, building dynamic support and demand for the services of "PEET" members. Now more than ever it pays to qualify as a "PEET" member!

HOWARD W. SAMS & CO., INC.

Howard W. Sams & Co., Inc., Dept. 6-D2
1724 E. 38th St., Indianapolis 6, Ind.

- Send me full details on how I can qualify as a member in the "PEET" Program.
- Send Free Photofact Cumulative Index

Shop Name _____

Attn: _____

Address _____

City _____ Zone _____ State _____

PLANNING A MASTER TV SYSTEM ?

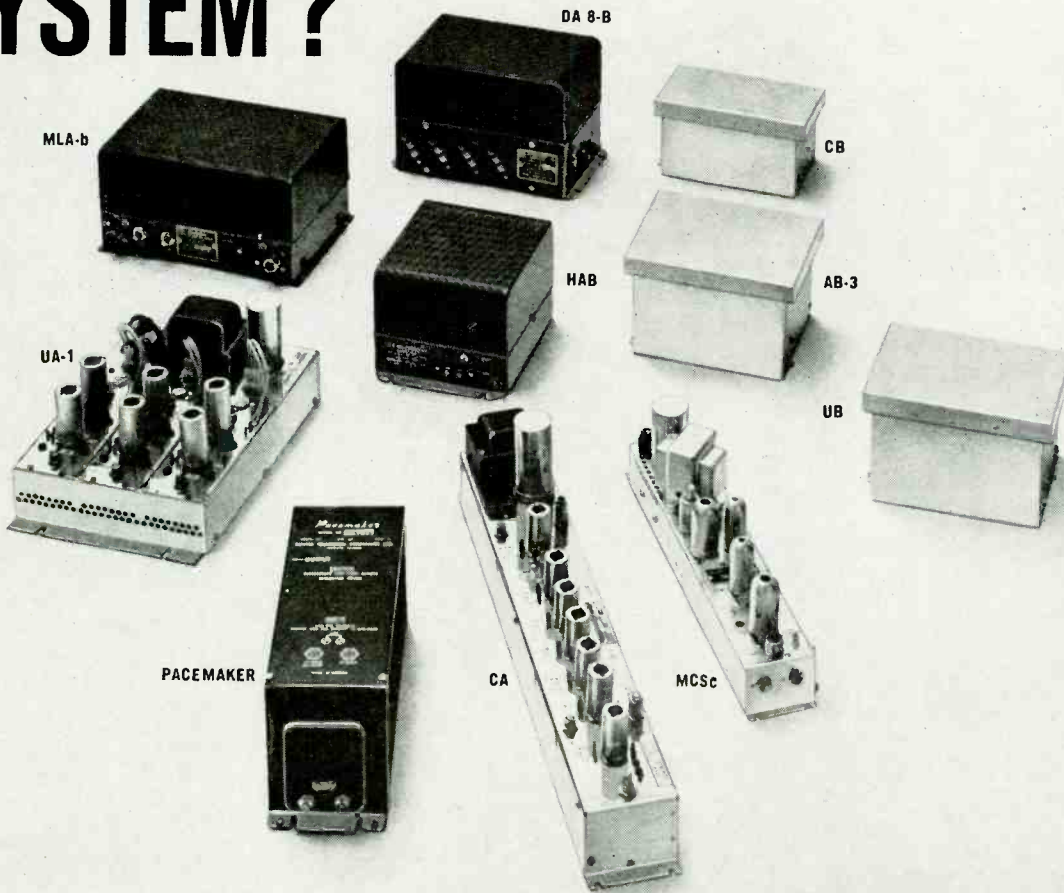

select the ideal head end from the world's only matched and integrated line
BLONDER-TONGUE MASTER TV AMPLIFIERS

	MODEL	IMPEDANCE INPUT	IMPEDANCE OUTPUT	FREQUENCY	GAIN MINIMUM	MAXIMUM OUTPUT *1% distortion **3% distortion	FEATURES	LIST PRICE
BROADBAND AMPLIFIERS	MLA-b	75 ohms	75 ohms	VHF	40db	*2 v/band	Separate hi & lo band gain & tilt controls.	142.50
	HAB	75/300 o.	75/300 o.	VHF/FM	25db	*0.9 v loband *0.6 v hiband **2.5 v loband **1 v hiband	Separate hi & lo band gain controls.	72.75
	PACE-MAKER	75 ohms	75 ohms	VHF/FM	VHF, 35db FM, 30db	*2 v/band	Separate hi & lo band input.	99.50
	AB-3	300 ohms.	75/300	VHF/FM	25db	*0.9 v loband *0.6 v hiband **2.5 v loband **1 v hiband	Remote power supply. Weatherproof mast mounted.	104.95
	DA8-B	75/300 o.	75/300	VHF	10db per outlet	*0.2 v	8 outlets for distribution.	99.50
SINGLE CHANNEL	MCSc	75 ohms	75 ohms	VHF	35db to 46db	*1 v	Agc. dual mixing out-puts.	140.50
	CB	300 ohms	75 ohms	VHF	18db to 20db	*0.5	Weatherproof for mast mounting.	57.75
	PA (not illus.)	75 ohms	75 ohms	VHF/FM	65db	*1 volt	Agc. low noise figure.	275.00
	CA	75 ohms	75 ohms	VHF/FM	60db	*1 volt	Agc. dual mixing out-put.	235.00
	CAP (not illus.)	75 ohms	75 ohms	VHF/FM	60db	*5 volt	Agc. dual mixing out-put.	295.00
	UA-1	75 ohms	75 ohms	VHF/FM (FM LIST 99.50)	35db	*1 volt	Requires external power supply.	59.25
UHF	UB	300 ohms	300 ohms	CH 70 thru 83	14db	*0.5 volt	Mast mounted with remote power supply.	84.50
	STRATO BOOSTER (not illus.)	300 ohms	300 ohms	CH 72 thru 76	20db	*0.5 volt	Mast mounted with remote power supply.	103.75

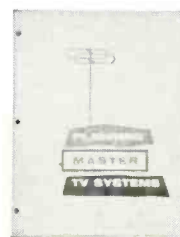

Today, contact your Blonder-Tongue distributor. Write for Free 28 page planning and installation manual. Free layout service. Also, engineering service available.

engineered and manufactured by

BLONDER-TONGUE
 8 Alling St., Newark, N. J.

Canadian Div.: Benco Television Assoc., Toronto.
 Export: Roeca Int'l. Corp., N. Y. 16, N. Y.-CABLES: AR LAB
 home TV accessories • UHF converters
 master TV systems • closed circuit TV systems

SPECIAL INTRODUCTORY OFFER

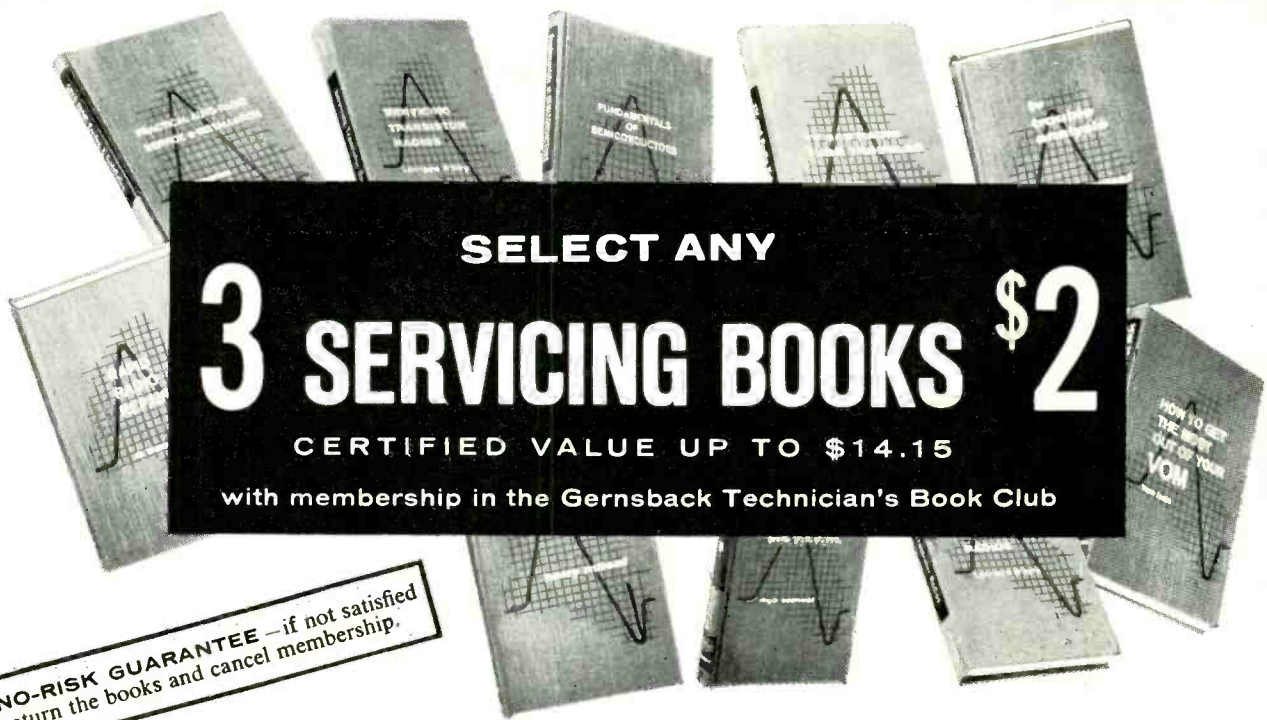

SELECT ANY
3 SERVICING BOOKS \$2
 CERTIFIED VALUE UP TO \$14.15
 with membership in the Gernsback Technician's Book Club

NO-RISK GUARANTEE—if not satisfied return the books and cancel membership.

WHY THIS SPECTACULAR OFFER?

Gernsback Library is making this offer to persuade more members to join the helpful Technicians Book Club. As striking as this offer is—it is only an introduction to the many advantages club members receive. The club gives you the chance to acquire at bargain prices—books by top technical writers on how to master fundamentals, learn new techniques that will help you get and stay ahead in electronics.

Here's the technical book buy of the year—not a collection of old or outdated volumes—but new books taken from the top of the Gernsback list of best sellers. Priced up to \$4.95 each—total value \$14.15.

WHAT THE CLUB OFFERS YOU

- Selection of the best modern electronics books by first-rank authors.

- Tremendous savings on each book—Club prices range from \$3.25 up for books regularly priced at \$4.60 and more.
- Chance to select one or more valuable books per month.
- Opportunity to buy books not always available in your community.
- Attractive volumes—carefully printed—handsomely cloth bound.
- Preselection privilege. A newsy bulletin regularly describes each selection and the alternates in detail.
- Budget-coddling payments. You agree to accept as few as four additional books a year. You pay for the books only after you receive them—and then only at the special club price—discounts up to 27%.

Highlights from books you will be able to select in coming months

- What you need to know about modern TV.
- All about transistors.
- Math for the electronic technician.
- Getting more out of the oscilloscope.

- Complete book on electricity for technicians.
- Picture book to help you solve tough TV problems.

HOW TO JOIN

- Mail the coupon below and start membership with any 3 of the books listed below. **SEND NO MONEY.** We'll bill you \$2—plus a few cents handling and mailing. If you're not satisfied with the books send them back and membership is cancelled.
- Each month you will receive a bulletin describing the choice of the month and alternates.
- You may select one or more books per month, or reject all books in a given month.
- You agree to accept only 4 additional books in the next 12 months. You may cancel anytime after that.
- Mail in the coupon below to Technicians Book Club, Dept. 42, 154 West 14th St., New York 11, N. Y. **SEND NO MONEY NOW** (unless you wish).

Choose the 3 books you want below for only \$2.00

<input type="checkbox"/> RAPID TV REPAIR By G. Warren Heath—Lists hundreds of tough TV problems alphabetically for quick and easy reference. Tells how to find'em and fix'em in minutes. Save servicing time with troubleshooting charts. Reg. price \$4.60.	<input type="checkbox"/> FUNDAMENTALS OF SEMI-CONDUCTORS By M. G. Scroggie—Thorough rundown on theory and practical applications of all kinds of semiconductors—transistors, diodes, photocells, solar generators, Hall effect devices, and others. Application of principles in practical devices. Reg. price \$4.60.	<input type="checkbox"/> HOW TO GET THE MOST OUT OF YOUR VOM By Tom Jaski—Get more mileage out of this versatile instrument. How to choose, build, work with and extend the use of the VOM. Reg. price \$4.60.
<input type="checkbox"/> THE VTVM By Rhys Samuel—Tells how the VTVM works, describes meter scales, probes, alignment, servicing. Offers dozens of new ideas on using the VTVM. Reg. price \$4.60.	<input type="checkbox"/> SERVICING TRANSISTOR RADIOS By Leonard D'Airo—Ins and outs of the specialized knowledge needed to handle these tricky sets. Theory, instruments to use, pitfalls to avoid, alignment, hints on how to handle transistors. Reg. price \$4.60.	<input type="checkbox"/> PRINTED CIRCUITS By Morris Moses—Practically an encyclopedia on printed circuits. How they developed, how to work with them, make your own, repair them. Reg. price \$4.60.
<input type="checkbox"/> TV TROUBLE ANALYSIS By Harry Mileaf—Unique "theory of trouble" approach shows you how to recognize component and circuit failure as they affect audio and video and fix them fast. Prepares you to service all types of sets. Reg. price \$4.95.	<input type="checkbox"/> RAPID RADIO REPAIR By G. Warren Heath—An alphabetized "instant" guide to finding tough troubles in FM, transistor, hybrid auto sets and other modern receivers. Reg. price \$4.60.	
<input type="checkbox"/> PRACTICAL AUTO RADIO SERVICE By Jack Greenfield—Covers transistor, hybrid FM and AM models. Compares auto with home radio servicing. Covers removal, installation, troubleshooting, power supplies, interference, suppression, tuner theory, etc. Reg. price \$4.60.	<input type="checkbox"/> SERVICING COLOR TV By Robert G. Middleton—Get ready for the color breakthrough! This book answers all your questions about chroma circuits, matrix testing, the flyback system, test equipment. Contains numerous troubleshooting charts. Reg. price \$4.60.	

ONLY 3 BOOKS TO A MEMBER PLEASE

TECHNICIAN'S BOOK CLUB
 Gernsback Library Dept. 42
 154 West 14th Street, New York 11, N. Y.

Enroll me as a member of the G/L Technician's Book Club. Start my membership with the 3 books I've checked for only \$2.00 (plus a few cents postage). Each month send me a brochure describing the current selections which I may purchase at special discount prices if I wish. I understand that my only obligation is to purchase just 4 additional books within the next 12 months, and that I may cancel anytime thereafter. I also understand that I may cancel immediately, simply by returning these first 3 books within 10 days.

NAME _____

ADDRESS _____

CITY _____ ZONE _____ STATE _____

Big Wheels in tv service



choose
Centralab
push-push
and push-pull
controls

No need to go round in circles looking for push-push and push-pull switch-type replacement controls. Centralab has them—in 4 different types: Adashaft, Universal Shaft, Fastatch (for dual concentrics); twin types (for stereo).

As you know, controls of this type are original equipment in the vast majority of recent TV, radio, and hi-fi sets—and only Centralab has a complete line of replacements.

Incidentally, these easy-to-use units can also be used to replace any switch-type volume controls.

So get down to earth, and get over to your Centralab distributor for push-push and push-pull controls.



ACTUAL SIZE

B-6204 S

Centralab

THE ELECTRONICS DIVISION OF GLOBE-UNION INC.
922C EAST KEEFE AVENUE • MILWAUKEE 1, WISCONSIN
In Canada: Centralab Canada Ltd., P.O. Box 400, Ajax, Ontario

ELECTRONIC SWITCHES • VARIABLE RESISTORS • CERAMIC CAPACITORS
PACKAGED ELECTRONIC CIRCUITS • ENGINEERED CERAMICS

Correspondence



FINE POINTS OF FILTER THEORY

Dear Editor:

Apparently in his week of intensive work on stereo (see "Does FM Stereo Follow Its Own Theory," *RADIO-ELECTRONICS*, October 1961, page 59), Mr. Crowhurst missed some of the fine points of modern filter theory. It is true that a linear phase (the designation "constant delay" is more descriptive) high-pass filter can be realized only with an infinitely long network. However, as Bode and Dietzold pointed out in the *Bell System Technical Journal* for April 1935, it is possible to approximate the constant-delay characteristic to an arbitrarily high frequency with arbitrary accuracy by using a suitably large number of critical frequencies. No filter, high pass or otherwise, has ever had a phase "advance." Furthermore, low- and high-pass Bode filters are not complementary networks. It is true that minimum-phase high-pass filters have a decreasing frequency, but a fundamental characteristic of the class of networks investigated by Bode is that they are not minimum phase. In any case, it is possible to synthesize the bandpass filter with other combinations, i.e., two low-pass filters of equal delay but differing cutoff frequencies. In fact, a direct design approach which includes no assumptions about percentage bandwidth was demonstrated by Bode. Thus the comments of Mr. Crowhurst on high-pass filters and low passband pass analogies are at best irrelevant.

ROBERT G. HUENEMANN

Zenith Radio Corp.
Chicago, Ill.

Dear Editor:

Mr. Huenemann's letter raises several points which would require quite an engineering treatise to answer in full. I must content myself with answering those things which are more basic to the concepts involved.

Agreed that *constant delay* is more descriptive than *linear phase*; I also realize a signal cannot arrive at the output of a filter before it is presented at the input. This does not preclude the possibility—in fact the inherent nature of high-pass filters—of producing *phase advance*, which is a different thing.

A transmission analogy will illustrate this distinction: A coax cable has a high-frequency cutoff, determined by its physical constants. On the other hand, a waveguide has a low cutoff

In All the World Never a Kit Value Like This

FM STEREO BY **knight-kit**[®]

ONLY **\$19⁹⁵** NO MONEY DOWN

**STEREO FM
MULTIPLEX KS-10A
ADAPTER KIT**



a pleasure
to build...
a revelation
in performing
quality

enjoy beautiful Stereo FM reception at unbelievably low cost

**IDEAL FOR USE WITH ANY FM OR FM-AM
TUNER WITH MULTIPLEX OUTPUT JACK**

PROOF OF SUPERIOR VALUE

• Self-powered—installs out of sight • Separation control for precise stereo adjustment (23 db separation) • Input sensitivity 0.2 volts • Frequency response 50-15,000 cps, ± 1 db • Noise filter (switchable) for use in weak signal areas • Top-performing circuit using 2 dual and 1 triple-purpose tubes • Power supply is transformer-operated; uses selenium rectifier • Pi-filter network for ripple-free B+ voltage — hum is practically inaudible • Prealigned coils • AC on-off switch • Three 36" connecting cables included.

Simply plugs into your tuner's Multiplex output and your amplifier's tuner inputs. With all connecting cables, tubes, parts, and famous Knight-Kit step-by-step instructions. 3 $\frac{7}{8}$ x 8 $\frac{1}{2}$ x 4". For 110-125 v. 60 cycle AC. Shpg. wt., 4 lbs.



*typical of the value and quality of over
100 other great KNIGHT-KITS*

order from

**KNIGHT ELECTRONICS DIVISION
ALLIED RADIO**

Now you can have the pleasure of an easy kit-building experience. Now you can enjoy all the tonal beauty and realism of Stereo FM broadcasts just by adding this quality Knight-Kit Multiplex adapter to your present stereo music system. The savings simply can't be duplicated. The quality can't be matched for anywhere near the price. Order the KS-10A Knight-Kit Multiplex adapter today—*no money down* (just check coupon). An unbeatable value at only . . . **\$19⁹⁵**

Satisfaction guaranteed or your money back

ORDER TODAY	KNIGHT ELECTRONICS DIVISION
	ALLIED RADIO, Dept. 68-D2 100 N. Western Ave., Chicago 80, Ill.
<input type="checkbox"/>	Ship me _____ KS-10A Knight-Kit Multiplex Adapter(s) 83YX656K
<input type="checkbox"/>	Ship on Allied's Credit Fund Plan—no money down
<input type="checkbox"/>	\$..... enclosed (check) (money order)
<input type="checkbox"/>	Send Free 1962 Allied 444-Page Catalog
Name _____	
Address _____	
City _____ Zone _____ State _____	

World's Only 'Portable Recording Studio'...



the all-in-one
Norelco

CONTINENTAL '400' 4-Track Stereo Tape Recorder

A recording studio in a suitcase—that's how NORELCO '400' owners describe this most advanced (and most popular) self-contained stereo tape recorder. **VERSATILITY:** 4-track stereo recording and playback, as well as 4-track monophonic recording and playback, at any of its 3 speeds. **PROFESSIONAL EXTRAS** (at no extra cost): mixing, monitoring and sound-on-sound facilities. **AUDIO FACILITIES:** completely self-contained, including dual recording and playback preamplifiers, dual power amplifiers, two NORELCO wide-range, stereo-matched speakers (one in the detachable lid) and stereo dynamic microphone. For complete specifications, write to NORELCO. In the meantime, see and hear the Continental '400' at any leading Sound or Photo Dealer.

High Fidelity Products Division
NORTH AMERICAN PHILIPS COMPANY, INC.
230 Duffy Avenue, Hicksville, L. I., N. Y.

frequency and is thus comparable to a high-pass filter.

Three velocities are associated with a waveguide—group velocity, *phase* velocity and free transmission velocity. The last-named is the velocity of propagation of electromagnetic waves in the medium contained in the guide—normally the velocity of light. Group velocity is lower and phase velocity *higher* than free transmission velocity.

A given bunch of energy transmitted by the frequency in question in this waveguide is delayed, but the phase of waves transmitting the energy is progressively advanced, relative to transmission in free space. Waveguide lenses utilize this fact. The waves do not leave before they enter, but they do appear to travel faster than their *normal* velocity.

A similar thing happens in a high-pass filter and equivalent actions. Take a simple crossover. If an input sine wave of crossover frequency is divided across an inductance and a capacitance with resistance terminations, the voltage across the capacitance is behind the input voltage in phase, while that across the inductance is correspondingly advanced. Successively more complicated crossovers increase the amount of delay and *advance* in complementary fashion.

We are quite aware of the varied approaches to filter design. We have also examined many multiplex adapter circuits, using filters which, from the values shown, were obviously designed from classic transmission-line-derived data which assume matching termination at input and output. These filters are then fed from a cathode follower and loaded with almost open circuit, which completely invalidates their predicted performance, in both magnitude and *phase*. Small wonder they don't perform to spec!

May I emphasize what the original article pointed out—the Bode filter in the Zenith publication is a *low-pass* configuration, not bandpass. My criticism was directed at high-pass and bandpass types, within practically realizable possibilities. The simple low-pass configurations come close to phase-linear, and the Zenith circuit, critically adjusted, should come very close indeed.

NORMAN H. CROWHURST

Audio Design Service
New York, N. Y.

ABOUT THAT MIXER

Dear Editor:

I wish to protest an absurdity in an article by James A. Fred, "Spice-Can Audio Mixer," which appeared in the February issue.

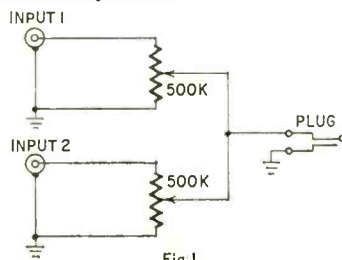
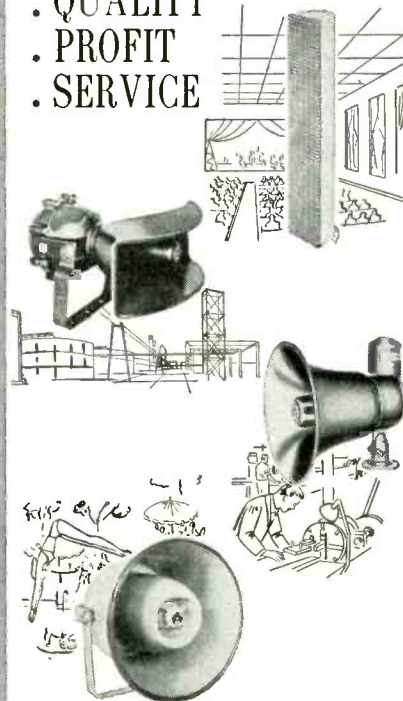

Fig. 1

IN P. A. SPEAKERS as in Mike Stands ATLAS SOUND offers

- FULL LINE
- QUALITY
- PROFIT
- SERVICE



You name the application, there's an Atlas "job-rated" speaker just perfect for the task. Engineered to the latest state of the art, built for long life, priced right for your profit, supplied to serve all your needs. All with the same quarter-century know-how that brings you...

EVERYTHING IN MIKE STANDS & ACCESSORIES

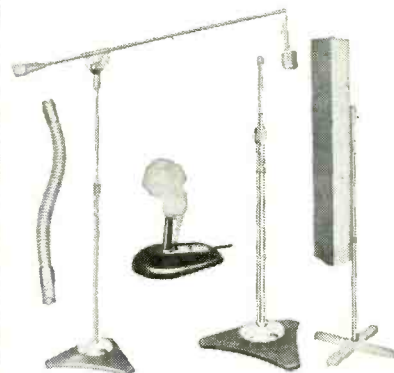

In addition to offering a stand for every purpose, only Atlas is ready and equipped to serve you with a complete line of support accessories, fittings and hardware so important to a well engineered and professional sound installation.

Write for full details
and latest catalog.



ATLAS SOUND DIVISION
American Trading and Production Corporation
1419-51 39th Street, Brooklyn 18, New York
Canada: Atlas Radio Corporation, Toronto

DOUBLES YOUR EFFECTIVE MANPOWER

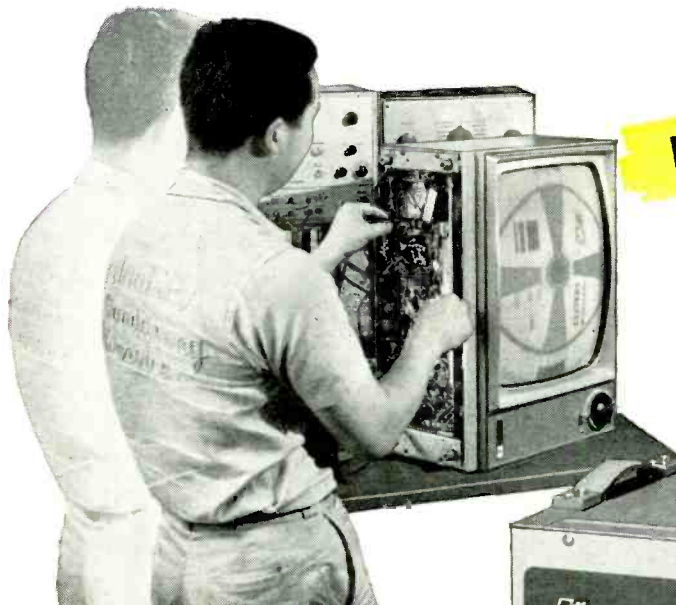

Fix "Tough Dogs" Fast!

Save Half Your Time!

Step Up Your Profit!

B&K NEW
MODEL 1076

TELEVISION ANALYST

for Black & White and Color



Check all circuits—Pinpoint any TV trouble...in minutes

**By Easy Point-to-Point Signal Injection,
You See the Trouble on the TV Screen and
Correct it—Twice as Fast and Easy!**

There's no longer any need to "lose your shirt" (and customers)—and worry about the lost hours you never recover—on "tough dogs" or even intermittents. The remarkable B&K Analyst enables you to inject your own TV signal at any point and watch the resulting test pattern on the picture tube itself. Makes it quick and easy to isolate, pinpoint, and correct TV trouble in any stage throughout the video, audio, r.f., i.f., sync, and sweep sections of black & white and color television sets—including intermittents. Makes external scope or wave-form interpretation unnecessary. Most useful instrument in TV servicing! Its basic technique has been proved by thousands of successful servicemen the world over.

The Analyst enables any serviceman to cut servicing time in half, service more TV sets in less time, really satisfy more customers, and make more money.

Model 1076. Net, \$29995

Available on Budget Terms. As low as \$30.00 down.

Combines all the features of both
the Model 1075 and Model A107

- | | |
|---|---|
| COMPLETE R.F. and I.F. | HI-VOLT INDICATOR |
| VIDEO TEST PATTERN | YOKE and HI-VOLTAGE
TRANSFORMER TEST |
| COMPOSITE SYNC | Also Now Provides: |
| FM MODULATED AUDIO | SWITCH-TYPE TUNER |
| COLOR PATTERNS | NEGATIVE BIAS SUPPLY |
| HORIZONTAL and VERTICAL
PLATE and GRID DRIVE | AGC KEYING PULSE |
| B+ BOOST INDICATOR | PICTURE TUBE MODULATION |

B&K

B&K MANUFACTURING CO.
1801 W. BELLE PLAINE AVE • CHICAGO 13, ILL.
Canada: Atlas Radio Corp., 50 Wingold, Toronto 19, Ont.
Export: Empire Exporters, 277 Broadway, New York 7, U.S.A.

See Your B&K Distributor or Write for Bulletin AP18E

ARE YOU GETTING THE MOST VALUE FROM YOUR MEASUREMENT DOLLAR? ... Compare all

features and you'll agree, BEST BUY IS EMC!



EMC'S NEW MODEL 212 TRANSISTOR ANALYZER ... Checks DC current gain in 3 ranges to 200. Tests for leakage. Checks all transistors as oscillators both in and out of circuit. Can be used to signal trace AF, IF or RF circuits. Checks condition of diodes. Tests battery voltage on 0-12 scale. Checks DC current drain on 0-80 ma scale. Supplied with complete instruction manual, transistor listing and pair of test leads.

Model 212 \$18.50 Wired
Model 212 Kit \$13.50



EMC'S NEW MODEL 213 TUBE TESTER ... Completely modern! Completely flexible! Completely new! Checks all the new 12 prong (Compactron),

Nuvistor, Novar, and 10 prong tubes; in addition to octal, loctal, miniature, and 9 prong tubes. Tests each tube for shorts, leakages, intermittents, opens, as well as for quality. Each section of multi-purpose tube is checked separately. Magic eye, Voltage Regulator and HI-FI tubes are also tested. Unique switching arrangement makes the checker obsolescent proof. Supplementary tube listings supplied periodically at no cost to keep instrument up to date. It comes complete with instructions and tube charts in ring bound manual.

Model 213 (in bakelite case with strap) \$28.50 Wired Model 213 Kit \$18.90
Model 213P (in wood carrying case) \$32.25 Wired Model 213P Kit \$21.90



EMC'S NEW MODEL SA SOCKET ADAPTOR ... Enables user to check 12 pin Compactron, Nuvistor, Novar and 10 pin tubes with any type tube tester including mutual conductance type.

Model SA \$9.45 Wired
Model SA Kit \$4.95

Yes, tell me more, send me FREE a detailed catalog of the Complete EMC Line. Dept. RE-462
NAME _____
STREET _____
CITY _____ STATE _____

EMC Electronic Measurements Corp.
625 B'way, New York 12, N. Y.
Ex. Dept., Pan-Mar Corp., 1270 B'way, New York 1, N. Y.

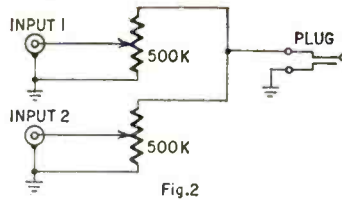

The circuit he shows (Fig. 1) does not work! When the wiper on either pot is turned to its grounded position, the output plug is shorted to ground, effectively killing the other channel too.

I propose an alternate circuit which I have tested, and which does work (Fig. 2). ROBERT SNAPP
Berea, Ohio

[When reading Mr. Fred's article you will notice he specifies the operating conditions. He uses the device to mix two signals and to increase the level of one of them when necessary. He never uses the mixer to cut off any one channel completely. Your circuit (Fig. 2), while effective, has disadvantages too. Let's say you were feeding input 1 with a crystal phono cartridge. As you varied the mixer pot for this channel, you would vary the impedance the crystal cartridge sees and would, in turn, change its frequency characteristics. This is certainly undesirable. Perhaps the most effective yet simple mixer circuit is the one in Fig. 3. Here the input

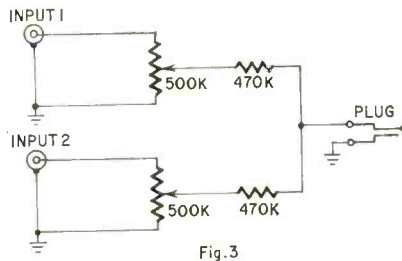

impedance is fixed, yet both channels are isolated. If you wanted to cut one channel off, you could without affecting the other.—Editor

FM ANTENNA STORY—THE VERY BEST

Dear Editor:

Edward M. Noll's article, "FM Antennas for Better Listening," February 1961, is one of the best I have seen on this subject. I would like to add some information.

In designing broad-band antennas, the center frequency is not taken as the arithmetic mean of the two end frequencies, but as the geometric mean. The arithmetic mean is computed by taking half the sum of the two end frequencies. The geometric mean frequency is found by taking the square root of the product of the two end frequencies. While the error here is slight, it is appreciable in other applications. Arithmetic mean frequency:

$$\frac{108 + 88}{2} = 98 \text{ mc}$$

Geometric mean frequency:

$$\sqrt{108 \times 88} = 97.5 \text{ mc}$$

WILLIAM F. DOHERTY
Sacramento, Calif. END



YOU WON'T FIND THIS CONTROL ON ANY OTHER P.A. AMPLIFIER IN THIS PRICE CLASS



Mixers aren't new. But one that will fade and blend two program sources with a single control is. That's one of the exclusive features on the new Harman-Kardon COMMANDER Series of public address amplifiers. Equally unique, yet typical of the exceptional value of this product group is an Anti-Feedback Filter which increases sound output by 100% under difficult acoustical conditions and Multiple Inputs for still greater installation flexibility. That's not all! The popular priced COMMANDER Series includes features usually reserved for costlier "deluxe" equipment such as: master volume control; input for magnetic cartridge; outputs for tape recorder, booster amplifiers and both 25 and 70 volt speaker lines; locking covers; DC on filaments of hi-gain stages, etc. Get all the facts now. Write Commercial Sound Division, Harman-Kardon, Plainview, L.I., N.Y.

Send free detailed catalogs: Desk 4F

Name _____
Address _____
City _____ State _____

harman kardon



Tips for Technicians

Distributor Division, P. R. Mallory & Co. Inc.
P. O. Box 1558, Indianapolis 6, Indiana

Why some filter capacitors develop hum... and some don't

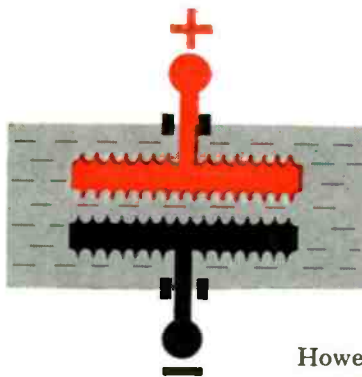

Aluminum electrolytic capacitors are widely used as filters in DC Power Supplies. This is because of their large capacitance in relatively small size. All in all, they do an efficient job of reducing ripple (hum) to acceptable levels.

However, all electrolytic capacitors are not alike. This is often why some types seem to allow hum to rise to objectionable levels more quickly than do others. In order to understand why, we must investigate actual construction methods.

As you know, electrolytics are basically made by depositing a film of aluminum oxide on aluminum foil to form the positive anode. The oxide is the dielectric. A semi-liquid electrolyte surrounds the anode and is actually the negative cathode. In order to connect this semi-liquid cathode to a terminal, a second piece of aluminum foil is used. This is often called the cathode, but it is not. It is actually only the *cathodic connection*. (The preceding describes a "polarized" electrolytic capacitor.)

When high ripple currents are applied to polarized electrolytics, a thin oxide film forms on the so-called "cathode". It begins to assume the characteristics of a second anode. This in turn, has the same effect as placing two capacitors in series. Consequently, overall capacitance is reduced. Inevitably hum increases.

This action is especially noticeable in electrolytics which use plain foil as the "cathode". This is simply because the oxide builds up over a relatively small area.

Mallory avoids this problem by etching the "cathode" on electrolytics. As a result, oxide build-up is spread over a vastly increased area. Therefore, ripple currents are maintained at very low levels for very long time periods.

Of course etched "cathodes" cost a lot more to make. But you get them from Mallory at *no extra cost*. There's much more to the Mallory capacitor story, but we'll leave that to another TIP.

Meanwhile, see your local Franchised Mallory Distributor for capacitors, resistors, controls, switches, semiconductors, and batteries. In fact, he's the man to see for *all* of your electronic component requirements.



EICO®... UNCOMPROMISING ENGINEERING

BEST BUYS IN SERVICE INSTRUMENTS: everything from Scopes to Probes



DC-5 MC
5" Scope #460
Kit \$79.95
Wired \$129.50

Also Avail.—5" Push-Pull Scope #425
Kit \$44.95 Wired \$79.95



Peak-To-Peak
VTVM #232
& †Uni-Probe®
Kit \$29.95
Wired \$49.95
VTVM #221
Kit \$25.95
Wired \$39.95

†Pat. #2,790,051

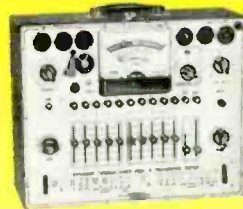

Dynamic Conductance
Tube & Transistor Tester #666
Kit \$69.95 Wired \$109.95
Complete with steel cover & handle



TV-FM Sweep Generator
& Marker #368
Kit \$69.95 Wired \$119.95

BEST BUYS FOR INDUSTRIAL TESTING: everything from Bridges to Supplies

NEW Metered
Variable Auto-
Transformer AC
Bench Supplies:
#1073 (3 amp.)
Kit \$35.95
Wired \$47.95
#1078 (7½ amp.)
Kit \$42.95
Wired \$54.95



NEW Extra-Low-
Ripple 6 &
12 Volt
Battery
Eliminator
& Charger #1064
Kit \$43.95
Wired \$52.95



NEW AC
Volt-Watt
Meter #260
Kit \$49.95
Wired \$79.95



1350 Combinations!
Series/Parallel R-C
Combination Box #1140
U.S. Pat. No. 2954518
Kit \$13.95 Wired \$19.95



BEST BUYS IN STEREO & MONO HI-FI: everything from Tape Decks to Speakers

Transistorized
Stereo/
Mono
4-Track
Tape
Deck
Wired
Model
RP100W
\$399.95
Semi-Kit
Model
RP100K
Electronics in Kit form \$299.95

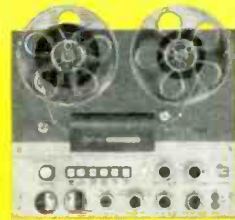

An original, exclusive EICO product
designed and manufactured in the
U.S.A. (Patents Pending)

NEW FM-Multiplex
Autodaptor MX99
Kit \$39.95 Wired \$64.95
Cover optional, \$2.75
Designed for all EICO
FM equipment (HFT90,
HFT92, ST96) and any
other component quality,
wide-band FM tuner.



NEW 70-Watt Integrated
Stereo Amplifier ST70
Kit \$94.95 Wired \$149.95



NEW FM-AM Stereo Tuner ST96
Kit \$89.95 Wired \$129.95 Inc. FET

NEW 40-Watt Integrated
Stereo Amplifier ST40
Kit \$79.95 Wired \$129.95



Bookshelf Speaker System HFS1
Kit \$39.95 Wired \$47.95

BEST BUYS IN "HAM" GEAR: from Transmitters to Code Oscillators



NEW 60-Watt CW Transmitter #723
Kit \$49.95 Wired \$79.95



90-Watt CW Transmitter #720
U.S. Pat. No. D-184776
Kit \$79.95 Wired \$119.95



Universal Modulator Driver #730
Kit \$49.95 Wired \$79.95
Cover E-5 \$4.50



Grid Dip Meter #710
Kit \$29.95 Wired \$49.95

Over 2 MILLION EICO instruments in use. Compare EICO side-by-side critically with products selling for 2 or 3 times more. Buy your EICO right "off the shelf" from 1500 neighborhood dealers coast to coast, most of whom offer budget terms.

BEST BUYS IN CITIZENS TRANSCEIVERS AND TRANSISTOR RADIOS



Over 80 unique
products to
choose from!

EICO, 3300 N. Blvd., L.I.C. 1, N.Y.

Send free 32-page catalog & Distributor's name.

Send Free Schematic of Model No. _____

Send new 36-page GUIDEBOOK TO HI-FI for which I enclose 25c for postage & handling.

Name _____

Address _____

City _____ Zone _____ State _____



Citizens Band Transceivers
From: Kit \$59.95 Wired \$89.95
Superhet; prealigned xmitter
osc; match different antennas
by variable "pi" network.
Single & multi-channel models.



NEW Walkie-Talkie
Citizens Band
Transceiver #740
Kit \$54.95
Wired \$79.95
Carrying Case \$3.95.
Complete with rechargeable
leakproof battery & charger.
Operates 2500 hours on the battery.
U. S.-made by EICO.



Transistor Portable Radio RA6
Kit \$29.95 Wired \$49.95 Incl. FET

Listen to the EICO Hour, WABC-FM, N. Y. 95.5 MC, Mon.-Fri., 7:15-8 P.M. Add 5% in the West © 1962 Electronic Instrument Co. Inc., 3300 N. Blvd., L. I. C. 1, N. Y.

ELECTRONIC GERM ERADICATION

... *Most Micro-organisms Can Be Killed Electronically* ...

ONE of the great problems that have been facing humanity for ages is that of germ eradication. Possibly the most dangerous organisms that attack and kill man are microscopic and sub-microscopic. Many of the most virulent are airborne.

In the wide open spaces, as well as forests, where there is considerable oxygen and ozone, airborne micro-organisms do not thrive as well as in crowded cities where humans, infected with a variety of germs, breathe them at and on their fellow-man.

On streets, subways and buses, in crowded offices, motion picture houses, theaters and all other places where humans come into close contact with each other, germs are constantly transferred from man to man—often with epidemic results.

Unfortunately, against this constant transference of disease-bearing organisms, man so far has had practically no defense. It is true that during epidemics some people have worn masks covering nose and mouth, but such masks have been practically worthless, because the germs penetrate the poorly designed gauze masks easily. Even the finest porous porcelain filters would be useless, because, first, they would not allow a human to breathe, and, second, many micro-organisms of the virus type pass readily through even porcelain.

One of the most dangerous micro-organisms that plague mankind today is the gram-positive bacterium—the *staphylococcus*, the cause of pus formation throughout the body, in boils, abscesses, etc. These germs are found in various internal human organs; they cling to the skin, to bedsheets, beds, walls, and are widespread in practically all hospitals. So far few chemicals or medicines are potent enough to eradicate “staph” efficiently.

It would seem to us that so far science and medicine have attacked the problem from the wrong end. We try to kill off the micro-organisms with medicines, when we should try to attack them in their habitat—the air in which most of them live.

Many years ago, when the present writer was a manufacturer of storage batteries, he noted that few of the workers ever were affected by colds or respiratory diseases. The reasons for this are simple. When storage batteries are “formed,” the negative plates, after many charges and discharges, change inside and out into sponge lead. At the same time, the positive plate and its interstices turn into peroxide of lead. During the “forming” stage, all plates are immersed in dilute sulphuric acid. Routinely during the forming stage, the charging of the storage batteries goes on for many days, day and night.

When the workers come on in the morning, a thick fog or mist permeates the entire charging room—unless ventilators dissipate the sulphuric acid mist during the night. This mist is not harmful to humans who breathe it, often for years without discomfort. On the other

hand, it is invigorating, and evidently serves as a most efficient bactericide, particularly against respiratory germs. Storage battery manufacturers have long known these facts, but as far as we know, the idea of using sulphuric acid mist for therapeutic purposes has not been exploited. We have given this example only to show what can be done in this direction.

In our opinion, *all* indoor spaces where humans congregate should, as soon as possible, be equipped with well-engineered and medically researched electronic germ eradicators. Hospitals, subways, buses, offices, churches, theaters of every kind can in time be made reasonably germ-proof.

The first onslaught should be made as quickly as possible on that mass distributor of germs—our modern air conditioner. This new health menace admittedly *cools*, but it also stirs up all the germ-laden air in a closed room so efficiently that the micro-organisms soon find a good home in human noses and lungs. Probably most of the so-called summer colds can be traced directly to the efficient churning of germ-laden air onto healthy humans, who soon become infected. It should be noted, too, that most window air conditioners *merely recirculate the stale air*—no fresh air is admitted. (Central air-conditioning systems do add fresh air, routinely, at present.) Admittedly, the air conditioner extracts moisture and filters dust from the air, BUT THE GERMS *are never filtered out; they stay right in the room.*

Rest assured that future air-conditioner units will be equipped with efficient electronic bactericides. Indeed, we can readily foresee a boom of such machines in the near future because of the great need for them. It should be noted that, for efficient health purposes, *all* types of air conditioners should operate in all seasons, not only during the hot spells. Thus, during the cool seasons, the electronic germ-eradicator air conditioner should run, too—just the fan, not the cooling part.

Curiously enough, we have all—or most—of the means today to create efficient electronic germ killers. Let us mention only one.

Draw all air ejected into the room from the air conditioner through a special chamber which has a number of high-voltage *quenched* air gaps. The high heat and high voltage (50,000 to 100,000 volts) will kill any germ life. Of interest here is the fact that a high-energy quenched spark gap also generates ozone, which then would be discharged into the atmosphere. The percentage of ozone liberated by the spark gaps should be sufficiently low that it would be harmless to man. This system can be elaborated into many directions.

In the future, new *plasma* electronic applications can serve the same purpose, so can mass ionic discharge applications.

Once our medico-electronic engineers gain sufficient experience in the new art, much of our present-day germ infestation will be a thing of the past. —H.G.

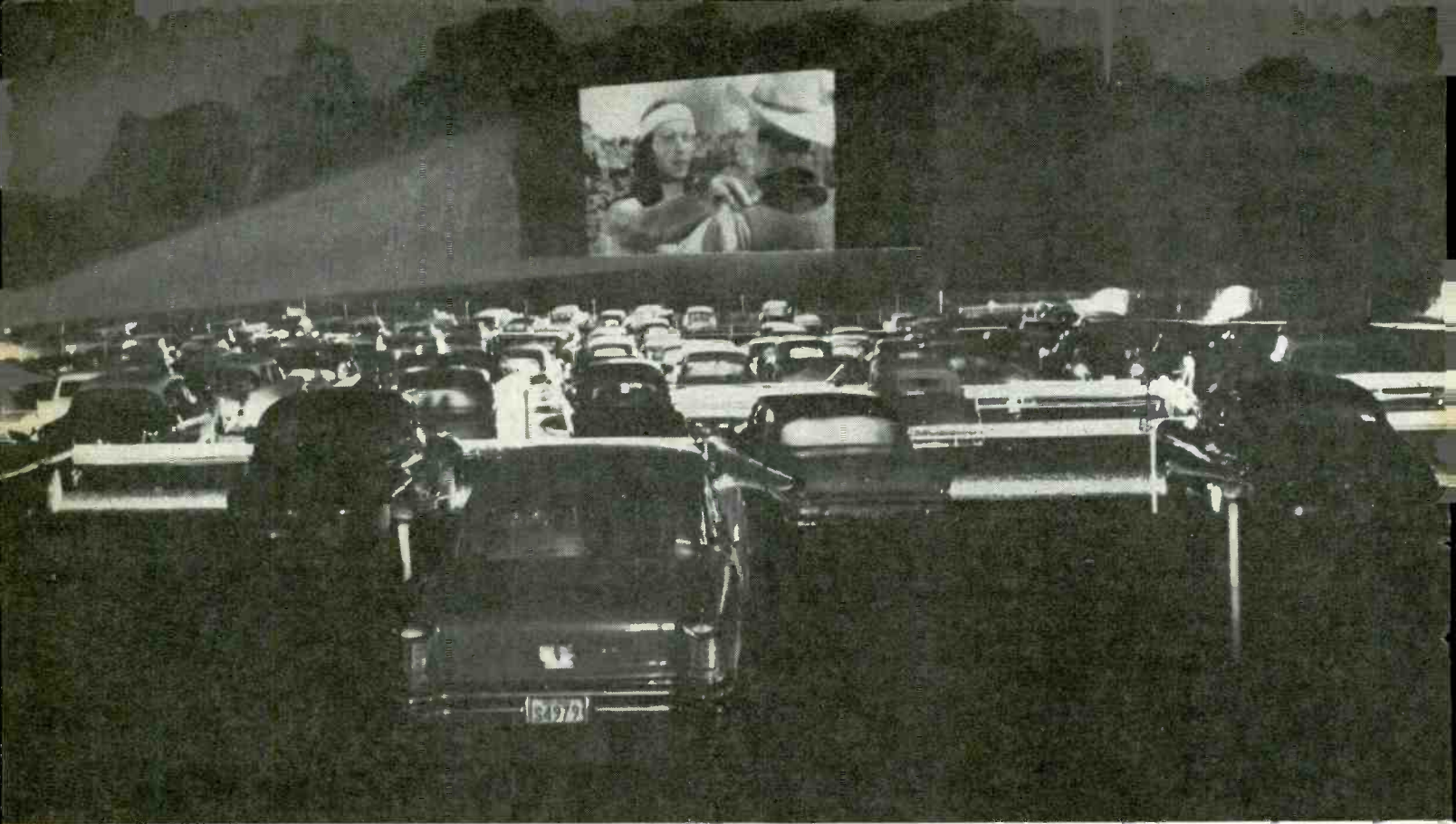

THE DRIVE-IN — electronic maze

Five miles of wiring plus a heap of amplifiers and speakers make up the audio system

Fig. 1—Audio corner of a drive-in's projection booth.



By **DANIEL M. COSTIGAN**

A DRIVE-IN MOVIE THEATER IS THE SITE of a rather unique audio installation. In place of the relatively few centrally or strategically located speakers at the business end of the conventional PA system, the drive-in dissects its audience into hundreds of isolated segments and provides each with its own individually controllable speaker. In a sense, it's a PA system that speaks privately to its public.

The number of speaker positions in a drive-in theater ranges from about 150 in a small installation to 2,000 or more in a large one. With the introduction, in the 1950's, of multi-channel sound, use of dual speakers brought the total to a possible 4,000 in a typical large-size drive-in featuring stereophonic sound. The average drive-in accommodates from 800 to 1,000 cars.

Ever wonder how you'd go about connecting 1,000 speakers to a single amplifier? Let's take a look at how this impedance-matching feat is handled.

Amplifiers

A visit to the projection booths of three or four drive-in theaters is likely to reveal a wide range of amplifier set-

ups. The differences may be due to variations in car capacity, make of equipment, or age of installation—or a combination of all these factors. In some installations, a single amplifier feeds the theater's entire speaker "field". In others, as many as a dozen separate amplifiers may be used.

Besides names like Motiograph, Simplex and Ballantyne (specialists in theater equipment), the visitor to the drive-in booth is just as likely to find sound equipment bearing names more familiar to hi-fi fans, such as Altec, RCA and Bogen.

Fig. 1 shows the sound section of a Simplex (National Theatre Supply Co.) installation at a 1,250-car drive-in. The four stacked amplifiers are Bogen 100-watters, designed specially for theater use. Three of them each feed one-third—about 416—of the drive-in's total speakers, while the fourth stands by, preheated, as a spare. In this particular installation, the spare is switched in by turning a knob to the number representing the amplifier that's in trouble.

As a rule, there are four speakers to every watt of amplifier output. The accepted standard is 1/6 to 1/4 watt per speaker.

Another Simplex installation, this one in a 900-car drive-in, is shown in Fig. 2. Here a driver amplifier is used in combination with a single Altec A-287 power amplifier (now obsolete) to feed all 900 speakers. The driver amplifier delivers 15 watts and the power amplifier 250 watts.

The Altec 260A (Fig. 3), one of the latest designs in high-power PA and industrial sound system amplifiers, is especially well adapted for use in medium to large drive-ins. By itself, this seven-tube 260-watter can feed approximately 1,000 speakers. A typical installation might use three such amplifiers—two operating and one spare.

The 260A's output stage is shown in Fig. 4. The pair of 813 heavy-duty pentodes, operating in class-AB1 push-pull, can deliver 260 watts continuously with 2% or lower distortion over a frequency range of 45 to 15,000 cycles. The 813's are driven by two 6AU6's, also wired in push-pull.

R1 and R2 are screwdriver bias-adjustment pots to balance the 813's. S1 is a "tube-checking" selector switch. It allows the operator to check the condition of each amplifier tube while the unit is in operation.

Motiograph Inc. (Chicago) offers the drive-in operator a choice of two amplifying schemes. One consists of the necessary preamps, one or more driver amplifiers and one or more power amplifiers, available with either a 75- or 250-watt output. This system is recommended for medium to large drive-ins, accommodating 850 or more cars.

The alternate scheme, recommended for smaller installations, consists of the necessary preamps and anywhere from 4 to 10 or more 25-watt power amplifiers. An 800-car drive-in employing this system would need 8 separate power amplifiers and probably 1 or 2 spares.

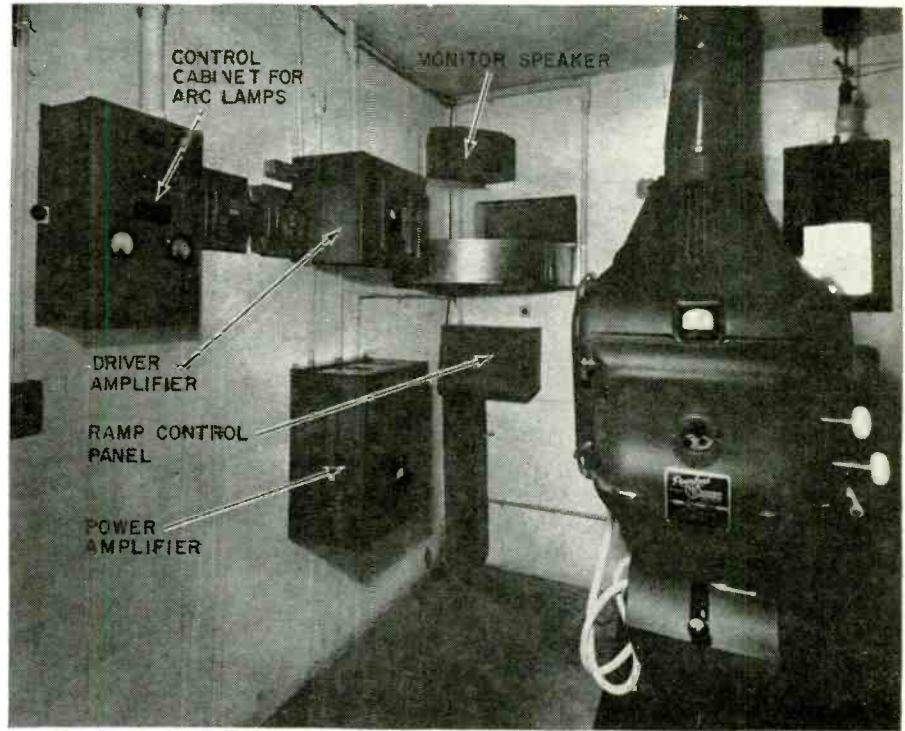

National Theatre Supply Co.

Fig. 2—Drive-in installation using only one power amplifier. Large object on right is one of booth's two projectors.

A typical RCA installation uses 70-watt power amplifiers in drive-ins of up to 1,120-car capacity, and 150 watters in larger installations. One to four 70-watt amplifiers, according to car capacity, are housed in wall-mounted cabinets. Each cabinet accommodates two amplifiers. The 150-watters are rack-mounted with a tip-out arrangement for easy servicing.

Speakers

The standard speaker is a 4-inch PM unit with a 3.2- or 4-ohm voice coil. Except for its slightly more rugged moistureproof cone, it differs from the conventional table radio speaker only in

the way it's mounted in its strong outer casing. The speaker unit must be lightweight, yet completely weatherproof, vandalproof and capable of being dropped or even run over by a car without having its voice coil knocked out of line.

RCA now produces a drive-in speaker with a plastic Impac case.

The Ballantyne Co. (Omaha, Neb.) makes a double-cone speaker. The outer cone, according to the manufacturer, not only protects the inner one (the driven cone), but improves the speaker's bass response at the same time.

The volume control, an integral

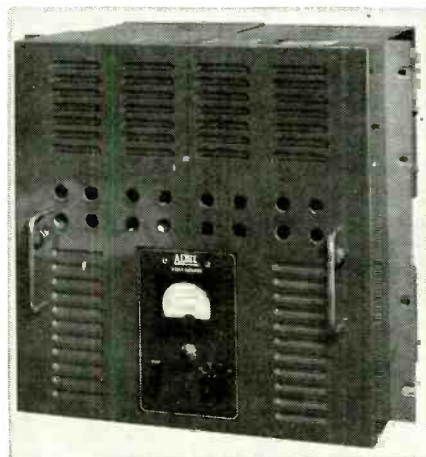

Fig. 3—Altec Lansing 260A amplifier, a popular unit in medium to large drive-ins.

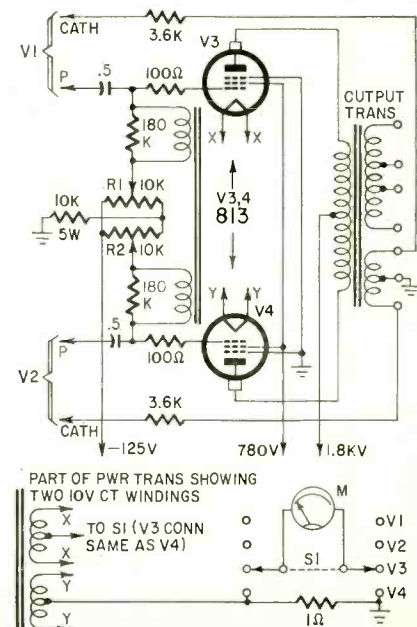

Fig. 4 — Output stage of Altec 260A.

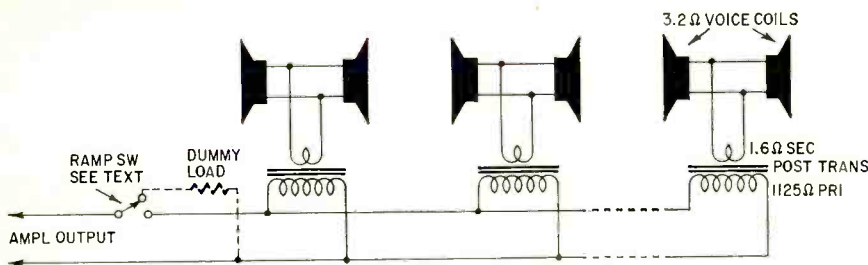

Fig. 5—Basic drive-in speaker circuit. Volume controls not shown.

part of most drive-in in-car speakers, is generally an L-pad, specially designed to withstand humidity and temperature extremes. At full volume, the speaker talks a bit louder—and with slightly better fidelity—than a small radio being played at normal room volume.

In a typical installation, speakers are not connected direct to the amplifier output. In the head of each speaker post is an intermediate transformer which couples the post's two speakers to the main output line from the power amplifier. In Simplex installations, the post transformer has a 1,125-ohm primary winding and a 1.6-ohm secondary to which the two speakers are paralleled. In a 1,000-car drive-in with one operating amplifier, the primaries of all 500 post transformers are connected in parallel across the amplifier output, presenting it with a 2.25-ohm load. Fig. 5 shows the basic speaker circuit. (In some multiple-amplifier systems the post transformer is eliminated and each amplifier feeds a small segment of the

speaker field directly.)

The 5 miles, or more, of No. 14 underground cabling required in a 1,000-car drive-in has a negligible effect on the load impedance. The added resistance—about 75 ohms—is distributed equally among the circuit's 500 parallel branches, increasing the impedance of each by slightly more than 1/10 ohm.

Auxiliary equipment

In addition to amplifiers and speakers, the drive-in audio scheme includes certain auxiliary apparatus necessary to insure a smooth-running show. Most of it is standard to all movie theaters, drive-in and conventional.

A preamp, for example, is generally required to raise the signal from the projector's sound head to a reasonable level before it is fed to the power amplifier. As a rule, the preamp is kept as close to the projectors as possible—generally on the front wall of the booth, near an observation port. Usually, separate preamps are provided for optical and magnetic sound heads.

Equally standard are the record player that provides music during intermissions (generally an inexpensive changer) and the monitor speaker unit (Fig. 2), which, in some installations, has provision for testing the outputs of individual amplifiers and the lines going out to the speaker field.

Perhaps the one piece of apparatus peculiar to the drive-in is the ramp control panel—a panel of switches through which the power amplifier output is split up to allow the speakers of each of the theater's parking ramps, or portions of each ramp, to be separately controlled. In case of trouble in a particular group of speakers, only the affected section need be taken out of service, leaving the remainder of the theater in operation.

Usually the switching circuit is arranged so that, when a switch is in the "off" position, a dummy load is substituted for the portion of the speaker field affected, thus leaving the total load impedance unaltered.

The Ballantyne MX-28A ramp control panel divides the speaker field into 20 sections. Each switch has three positions—OFF, TEST and ON. The TEST position allows each section of speakers to be monitored—while the show is in progress—through phones or the booth's monitor speaker to make sure the amplifier output is getting to them unimpaired.

Typical ramp control panels are visible in Figs. 1 and 2. Ramp switching sometimes is not employed in multiple-amplifier installations.

Servicing

Most drive-ins have contracts with specialized servicing organizations (RCA Service Co. and Altec's service division are two examples) for maintenance of their sound equipment. These organizations service drive-ins, conventional theaters and other large public-address and music installations. Besides being available for emergency calls, their services generally include a monthly checkup of all equipment in an installation and whatever preventive maintenance may be deemed necessary (replacement of weak tubes, etc.).

While it's possible that some smaller drive-ins may find it practical to do business with an independent local technician—the drive-in is under no obligation to sign a service contract with any specific organization—a more certain bet for the technician aspiring to do commercial PA work would be to apply at one of the service outfits and state his qualifications. I have been told that, although graduate engineers are preferred, there are openings from time to time for the technician genuinely interested in this sort of work and able to meet the qualifications.

In any event, it's a facet of electronics servicing worth looking into—especially for the "individualist" service technician in search of a specialty. The drive-in is a firmly established institution that promises to be a part of the American roadside scene for some time to come. END

AUDIO— simple but GOOD

THE DIAGRAM SHOWS THE AUDIO STAGES of a Grandin radio receiver. It is an economy model that uses a single triode-pentode.

The volume control is tapped 300,000 ohms above ground. Two circuits connected to this tap produce some bass and treble boost at low listening levels. The record player input is fed through an additional network, as shown, to

tiometer is moved toward the plate of the pentode, there is some treble cut because of the shunt capacitance between plate and ground. When the arm is moved the other way, the shunt capacitances form a sort of low-pass filter so feedback affects only the low-frequency bass.

Additional feedback is taken from the transformer secondary and applied

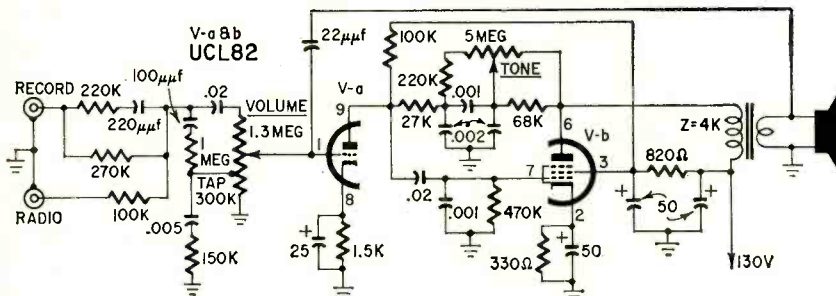

compensate for recording characteristics.

A feedback chain around the output pentode includes the tone control. When the arm of the tone control poten-

tiometer is moved toward the plate of the pentode, there is some treble cut because of the shunt capacitance between plate and ground. When the arm is moved the other way, the shunt capacitances form a sort of low-pass filter so feedback affects only the low-frequency bass. Additional feedback is taken from the transformer secondary and applied

COVER STORY

Novel features of the Knight 50-watt all-transistor stereo amplifier include special temperature control, single-ended push-pull and electronic filtering

new directions in hi-fi amplifiers



Specifications

Input sensitivities for full rated output: 2 mv for tape head; 2.5 mv for magnetic phono; 300 mv for ceramic phono and 0.5 volt for both tuner and auxiliary inputs.

IHFM music power: better than 50 watts (25 watts per channel) into 4-ohm loads; continuous sine wave power 36 watts (18 watts per channel) at any frequency.

Frequency response: ± 1 db from 20 cycles to 20 kc at full power.

Harmonic distortion less than 1% at rated output.

Cross-talk better than 40 db.

Hum level at tape head and phono inputs better than 65 db below rated output.

IM measures less than 2.0% at 15 watts per channel using 60-cycle and 7-kc signals mixed 4:1.

Output impedance approximately 2.0 ohms per channel.

By NORMAN KRAMER*

HIGH-FIDELITY MANUFACTURERS HAVE been slow to take advantage of transistor circuits. Yet, several important factors favor transistors.

One is that low-frequency response is possible practically to dc, with negligible phase shift. Also, the low-impedance circuits make extremely low hum and noise levels a reality. Finally, because of the low-impedance characteristics of transistors, output transformerless amplifiers driving standard impedance high-fidelity speakers become practical. Eliminating the output transformer, one of the most serious limiting factors in amplifier performance, has long been the hope of the hi-fi design engineer.

The output circuit

We built a complete 50-watt stereo amplifier that has no tubes in it at all. We started design with the output circuit. Conventional class-B operation requires both driver and output transformer, so it was to be avoided. As the amplifier must be compatible with existing hi-fi speakers, designs that depend on center-tapped voice coils were ruled out too. Capacitor coupling to the voice coil was also ruled out, since an extremely large coupling capacitor would be needed if the amplifier were to be flat down to 20 cycles. This left bridge or half-bridge operation.

We decided to keep the driver transformer as its effective gain would be needed. The driver circuit was set up for a transformer efficiency of less than 60% and delivers more than enough power to drive the output to clipping before adding feedback to keep distortion to a minimum.

Fig. 1 shows the basic circuit of

the single-ended push-pull output transformerless circuit we use. Bias voltage for V1 is supplied by voltage divider R1 and R2 while bias voltage for V2 is supplied by voltage divider R3 and R4. The bias causes enough quiescent collector current to avoid crossover distortion. R5 and R6 stabilize the circuit and make the transistors fairly independent of their individual characteristics. When a signal is fed to the amplifier, equal and out-of-phase voltages are fed from the driver-transformer secondaries to the base of each transistor. Thus each transistor is driven to conduction on alternate half cycles of the signal.

Both transistors are in common-emitter circuits and though they are in series across the split power supply they are in parallel across the single-

ended load. As far as the load is concerned, this means that the load impedance to match the transistors is only a

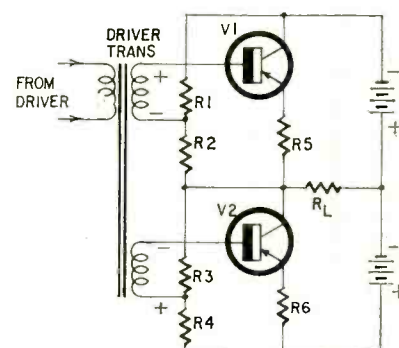
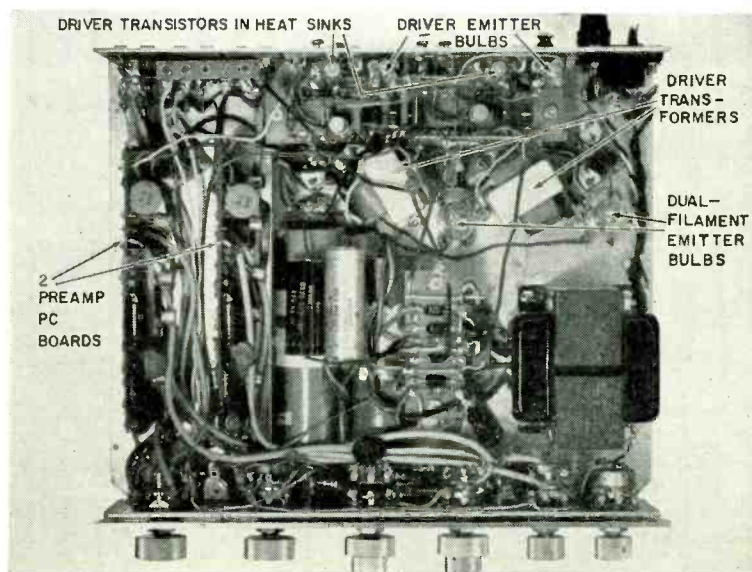

Fig. 1—Basic circuit of single-ended push-pull OTL amplifier.



Inside the cabinet. The little bulbs used to stabilize the amplifier transistors are pointed out.

*Chief engineer, Hi-Fi Div., Allied Radio Inc.

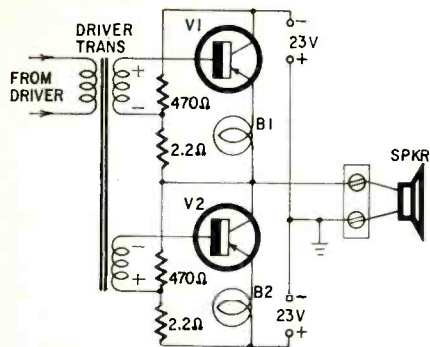

Fig. 2—Output circuit modified for dc stabilization with tungsten filament bulbs.

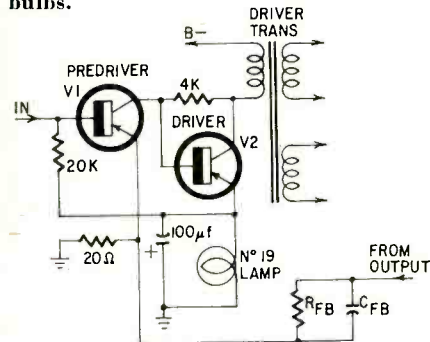

Fig. 3—Driver-predriver circuit.

fraction of that required by a conventional push-pull circuit.

Fig. 1 shows the transistors in series across the split power supply. With reasonably balanced transistors and reasonably similar supply voltages, the bridge is balanced and no current can flow in load R_L . If an input signal causes either transistor to conduct more than the other, the bridge becomes unbalanced and current flows through the load. Sine-wave signals fed from the driver will reach the transistors 180° out of phase and cause an amplified sine-wave signal across R_L . If the transistors are operated class A or B, no dc will flow through R_L . If R_L is replaced

with a speaker voice coil, the incoming signal will be reproduced faithfully. And since no dc flows through it, no distortion can be added from this source.

If this approach were tried in conventional push-pull circuitry, the voice coil would have to be center-tapped and only half of the voice coil would be used for each half cycle of the output signal. Naturally, this would reduce circuit efficiency. As far as ac is concerned, the transistors are connected in parallel across the two-terminal or single-ended load.

Thermal runaway

One of the main design considerations in high-power transistor circuits is that of limitations imposed by temperature. At high temperatures, transistor current must be controlled to prevent thermal runaway. Adequate heat-sinking and stabilizing the dc operating point will control transistor current and prevent any rapid rise in junction dissipation as temperature increases.

We use positive temperature coefficient resistors to stabilize the common-emitter circuit. These resistors replace R_5 and R_6 of Fig. 1. They are actually little light bulbs. We found the resistance characteristic of these tungsten filament bulbs ideally suited for this application (Fig. 2). We used bulbs similar to a 6-volt automotive taillight. They not only give the necessary dc stabilization, but also protect the speaker—just like extremely quick-blow fuses. Furthermore, because of their high positive coefficient of resistance, they are highly sensitive to current differences and make the transistors self-balancing.

Because the most load current flows with a 4-ohm load and lower currents with 8- and 16-ohm loads, the bulbs limit 4-ohm power more than 16-ohm power. This tends to make the amplifier approach a constant-power device rather than a typical constant-

voltage device.

Further protection against thermal runaway is in the heat-sinking of the power transistors. To assure that the heat sink can dissipate enough to prevent junction temperature buildup, the six power transistors are mounted directly to the .093-inch thick aluminum chassis. This gives a 300-square-inch surface for heat dissipation.

The driver-predriver circuit was chosen because it permitted good stability and transistor interchangeability. It also featured high gain and the high efficiency characteristics of class-A operation. Fig. 3 shows the circuit as it is used in the amplifier. The predriver is direct-coupled to the driver. This eliminates a large coupling capacitor and minimizes phase shift.

Thermal stability of V1 and V2 is largely determined by V1's collector junction temperature. V1's dissipation is low, and the main feedback loop is returned to its emitter through the feedback resistor and shunt capacitor.

Driving the medium-gain power transistors through a relatively low-efficiency driver transformer causes fairly high dissipation in V2. It is protected by dc stabilization (the bulb in its emitter circuit) and by heat-sink mounting to the chassis. The driver transformer was designed to be quite small, and even though V2 operates class A with its necessary dc unbalance, the high amount of negative feedback from the main loop and the local feedback of the 4,000-ohm resistor keep distortion low and extend the frequency response. The transformer secondaries are bifilar wound to avoid ringing in the crossover region.

About the preamp

The preamp section is built on two identical printed-circuit boards, each with all the equalization, tone control and high- and low-pass filter compon-

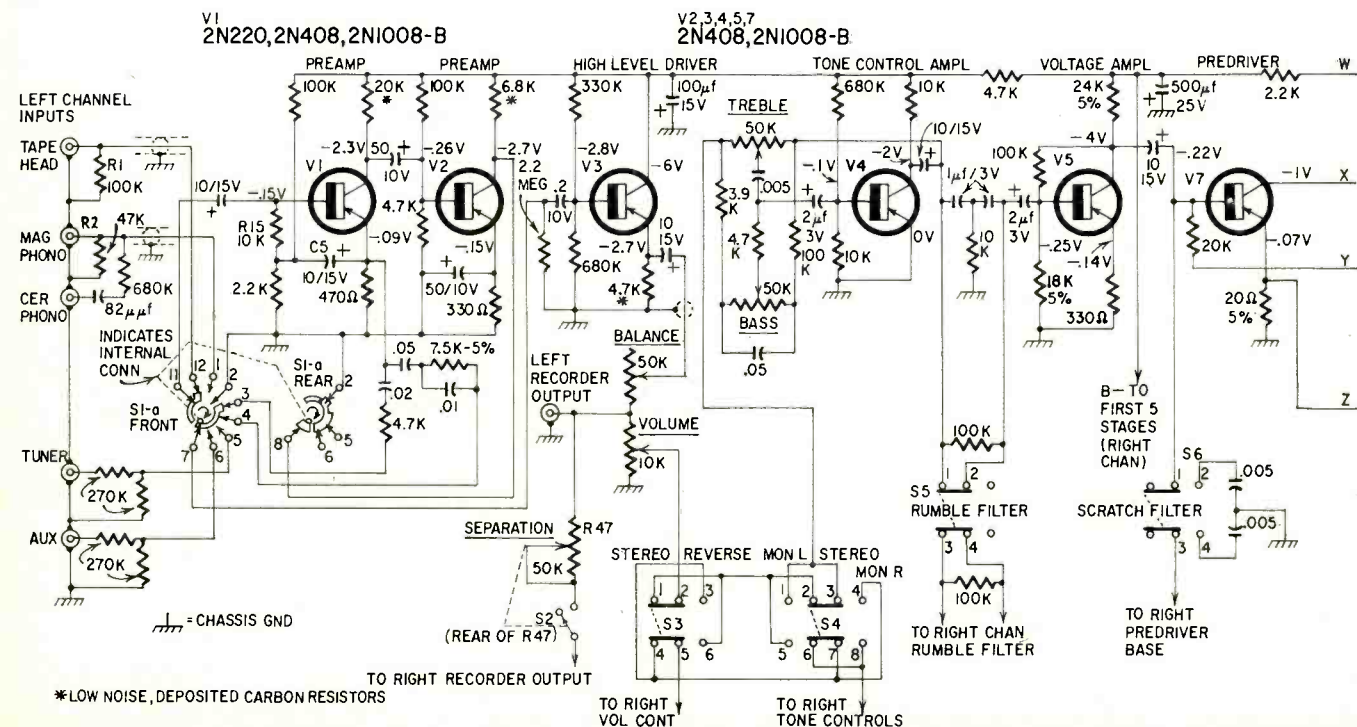

ents. There are five small-signal transistors on each board. The complete circuit of one of the amplifier channels is in Fig. 4. The circuit analysis that follows applies equally to both channels.

V1 and V2 make up the low-level preamp section. R2 is a 47,000-ohm resistor to match a magnetic pickup. These values can be changed to suit any particular stereo cartridge.

Feedback between V2's collector and V1's emitter gives V1 a high input impedance. The output voltage is converted to current in the feedback process, making the feedback current at the input proportional to the output voltage. S1 varies the components in the feedback path as different inputs are selected and provides either RIAA equalization for magnetic phono or NARTB equalization for tape head. C5 supplies local current feedback to each input stage, making R15 look considerably larger to the incoming signal.

Amplifier controls

Tuner and auxiliary inputs immediately following the preamp stages are switched into the circuit by S1. This switch grounds the preamp inputs and outputs as well as the other high-level input not being selected to eliminate any crosstalk between high- and low-level inputs. These high-level inputs are switched into V3, an emitter-follower stage which, though it offers no voltage gain, provides the necessary high input impedance for the signal while it offers low output impedance for driving the volume control, balance control and switching circuits.

Recorder outputs are taken from the high side of the volume control and are totally independent of all preamp controls other than S1. The balance control is a dual log-antilog potentiometer. It provides maximum balance range with minimum insertion loss. Separation control R47 has a switch on the back which allows for maximum

separation in the off position (switch open). As the control is rotated, the switch closes and the signals of both channels are blended till there is no separation.

S3 is a stereo reverse switch for reversing channels. S4 is a rather unique three-position mode switch. In its center position either normal or reverse stereo can be obtained, depending on the position of S3. However, in the left position any program fed into a left-channel input goes to both outputs, while in the right position any right input is fed to both outputs. S5 is the rumble filter. It consists of two stages of R-C filtering for a rather steep cutoff below 50 cycles.

The tone controls can be adjusted individually for each channel, with the internal friction clutch. Being feedback types, they have a variable turnover instead of the more common variable slope characteristic. The low distortion of this type of circuit plus the negative feedback make it an ideal choice for high fidelity. Biasing resistors on V4 make it relatively independent of beta and provide for good transistor interchangeability. V5 is a voltage amplifier which couples the signal into the basic portion of the amplifier. It has local feedback through a 100,000-ohm resistor from collector to base as well as an unbypassed emitter resistor. S6 is the scratch filter. It provides a slow roll off to control excessive brilliance without removing the high frequencies entirely.

Low-noise resistors are used in all critical stages and the low-level transistors are selected for their low-noise characteristics.

Power supply

The power supply delivers both a positive and a negative 23 volts. The transformer is both shielded and copper-banded to minimize radiation. Each secondary feeds a full-wave silicon rectifier with a capacitive input filter.

Because of the rather large cur-

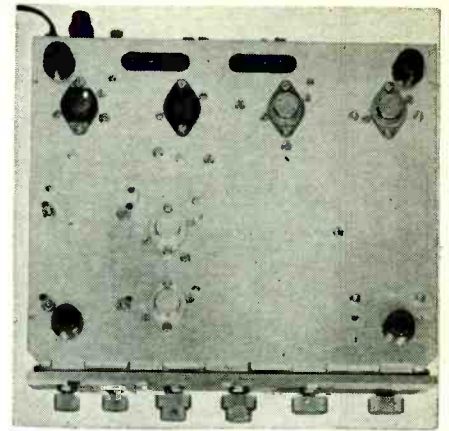

Six power transistors are mounted under the chassis. It is extra thick and makes an excellent heat sink.

rent needed for high power amplifier output, conventional filtering would be very costly, as extremely large capacitance would be needed for low ripple output.

V14 and V15 provide electronic filtering and some regulation. These circuits have the effect of an extremely large output capacitance. The negative supply has less than 1-mv ac ripple at power supply currents corresponding to full power output from the amplifier. The effective output capacitance of the negative supply is greater than 120,000 μf , while that of the positive supply exceeds 25,000 μf .

A center-channel speaker can be connected between the hot terminals of each of the usual two stereo speakers with only a small sacrifice in total output power if the center speaker is either a 16- or 8-ohm unit. This speaker will yield a difference signal, approximately 10 db down, for typical stereo signals in the amplifier.

The burnout-proof quality of the amplifier can best be illustrated by the fact that the output terminals of both channels can be shorted without damaging the output transistors, thanks to the limiting action of the four emitter bulbs. These tungsten lamps are extremely sensitive to applied voltage. If a wiring error or component failure places the full 23-volt supply on the lamp, it will burn out in approximately 70 milliseconds, which is plenty of protection for both speaker and transistor. Under normal conditions, the lamps will last the life of the amplifier. END

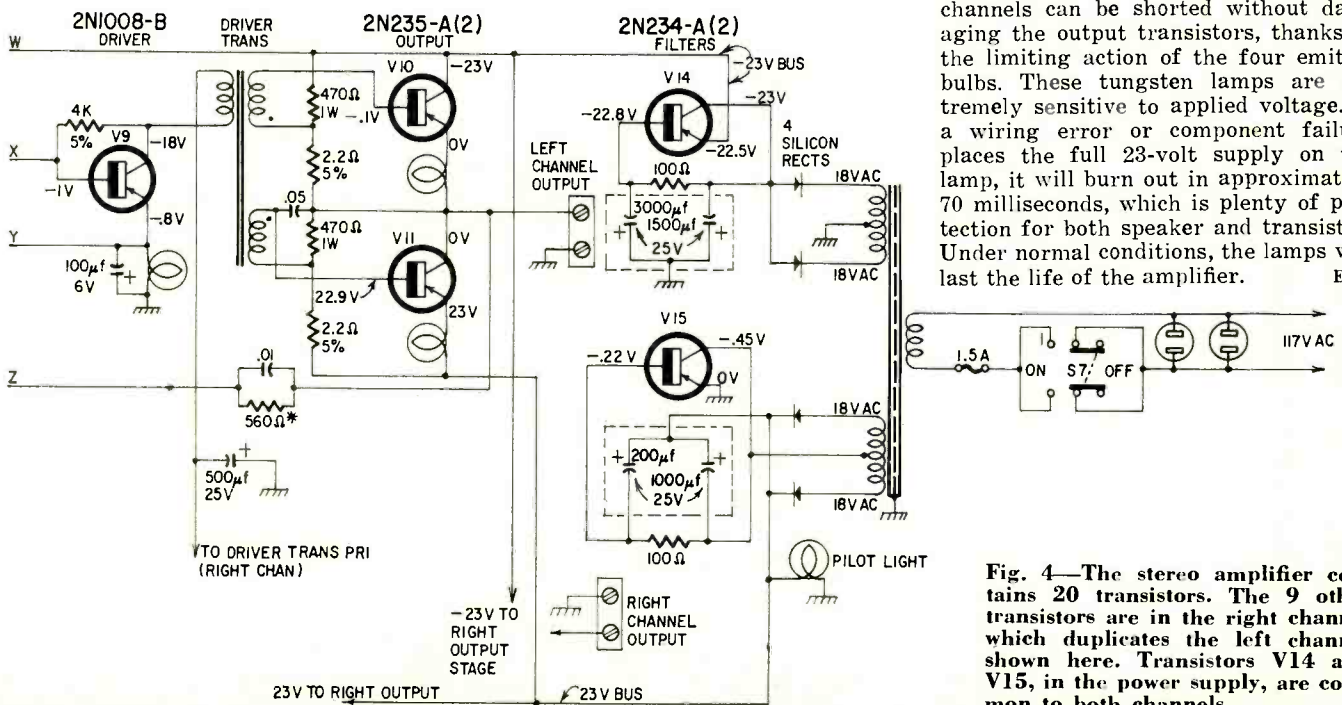
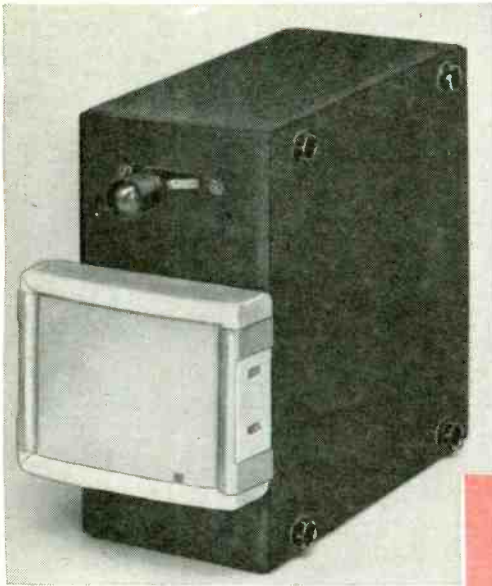

Fig. 4—The stereo amplifier contains 20 transistors. The 9 other transistors are in the right channel which duplicates the left channel shown here. Transistors V14 and V15, in the power supply, are common to both channels.

Battery-Powered Electroluminescent Emergency Lamp

runs 24 hours on two D-cells



By REGINALD W. NEALE

HERE IS A NOVEL PORTABLE LAMP THAT uses the light source of the future: electroluminescence. First available commercially in the early 1950's, the use of electroluminescent lamps (EL) has been growing steadily.

Like a capacitor, an EL lamp has two conductive layers separated by a dielectric. One of the conductive layers is transparent. Thousands of tiny particles of phosphor are embedded in the dielectric material. When an alternating voltage is applied to the two conductive layers, the phosphor particles absorb some of the energy and convert it to light. The amount and color of the light depends on the voltage and frequency of the power source.

The potential efficiency of an EL lamp is greater than that of an incandescent or fluorescent lamp. The light-emitting surface can be manufactured in large sizes and complex shapes. Because there is no filament to burn out, the life expectancy of an EL lamp is measured in years.

This combination of advantages makes EL lamps useful as lighted numerals on clock faces and instrument dials; as highway signs, house numbers, light switches and telephone dials which glow softly, and, in combination with arrays of photoconductive cells, as logic-circuit elements.

The portable nightlight described here uses an EL lamp available at most hardware and department stores. While it does not produce as much light as a conventional flashlight, it gives enough light to read a newspaper, check on the children at 1:00 am, change a tire or replace a fuse.

The circuit is essentially a low-power inverter operating at about 800 cycles (Fig. 1). A transformer matches the impedance of the transistor oscillator to that of the lamp at the operating frequency. The inverter lights the lamp brighter and more efficiently than ordinary household current. It will also flash the lamp repetitively at a high

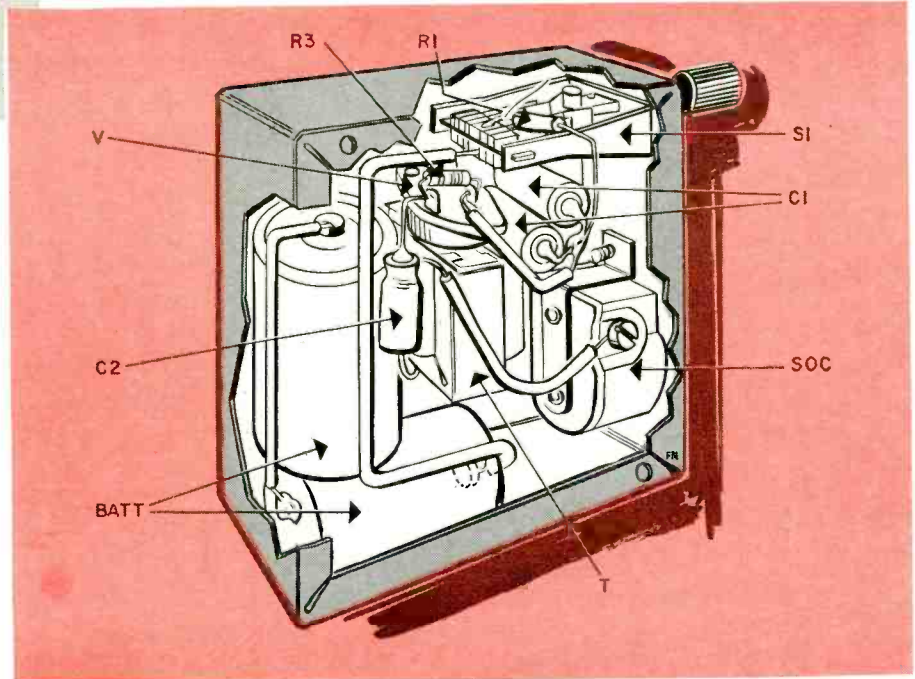

Pictorial diagram shows parts layout.

enough brightness level to be useful as a nighttime warning signal. Power consumption for continuous light output is about 250 mw, or one-sixth that

of an ordinary flashlight.

Two companies market EL lamps which work well with this device. Sylvania Electric's Panelescent lamp provides a bluish-green light, with a battery drain of 70 ma. General Electric's EL lamp has slightly less lighted area but produces a brilliant green light with a battery drain of 75 ma. G-E's Miniature Lamp Dept. can supply, on special order, unmounted

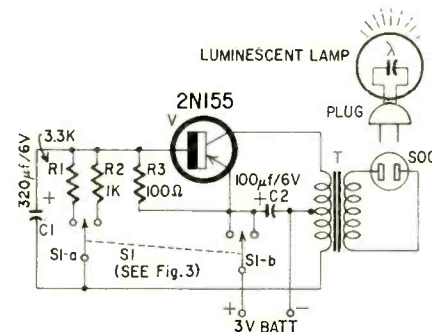

- R1—3,300 ohms, 1/2 watt
- R2—1,000 ohms, 1/2 watt
- R3—100 ohms, 1/2 watt
- C1—320 μf, 6 volts, electrolytic
- C2—100 μf, 6 volts, electrolytic
- BATT—3 volts (two D-cells in series)
- SI—4-pole double-throw switch, center off (Lafayette SW-20 or equivalent) only 2 poles are used
- SOC—117-volt female socket
- T—6V6 audio output transformer, tapped as explained in text
- V—2N155 or equivalent
- Luminescent lamp, see text
- Caes, 4 x 4 x 2 inches
- Miscellaneous hardware

Fig. 1—Circuit of the portable lamp is rather simple.

BENCH



TESTED

Unit worked well.

Provides enough light in a dark room to find your way around. If held close to a printed page, you can read with ease. However, no long-range beam is produced. You can't illuminate a picture on a wall at the opposite end of the room.

Make sure all components are securely fastened in place. Unit we received had an intermittent short. Once located and insulated, it caused no further trouble. Again, careful construction will eliminate the possibility of such faults.

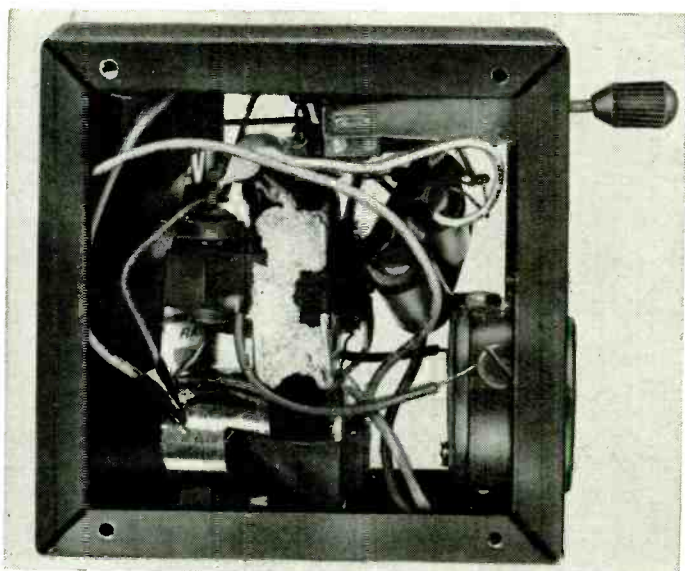

A peek inside the case. Note the liberal use of electrical tape to insulate components from each other.

lamps of this size in green, blue, yellow or white.

How to build it

Construction is simple. The switch and electrical outlet fasten to the case. The other components are taped together with electrical tape and soldered in place. Layout and lead dress are not critical.

Begin with the transformer. Almost any audio output transformer will operate in this circuit but, for maximum efficiency, use the type designed to match a 6V6 to a 3.2-ohm speaker. The common 5-watt type with 2-inch mounting centers is best. The transformer in my unit was salvaged from the audio output stage of a discarded TV chassis. No rewinding is necessary, but a tap must be added to the low-impedance winding.

Strip the paper insulation from the side of the transformer where the heavy leads come out, exposing the secondary winding. Make the tap on the outside layer, on the beginning turn of wire in that layer (Fig. 2).

Use electrical tape to fasten the transformer, transistor and one D-cell together. Then tape the other cell in place and wire the two cells in series. Select the outside lead of the transformer's tapped winding and solder it

to the transistor's collector. Trim the inside lead short and connect it to the negative side of C1. The unit will not operate properly if the inside and outside leads of the tapped winding are accidentally interchanged.

Wire the switch as shown in Fig. 3. Leave 1 1/4-inch leads on both resistors, and 3-inch leads on the switch terminals.

Cut holes in the case for the switch and outlet. Be sure to mount them far enough apart to prevent the lamp from interfering with the switch action when it is plugged into the outlet.

Final assembly

Slide the transformer and battery subassembly partially into the case and

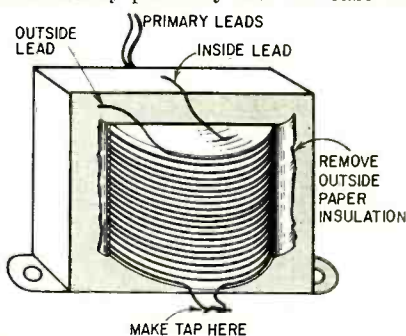

Fig. 2—Adding a tap to the transformer.

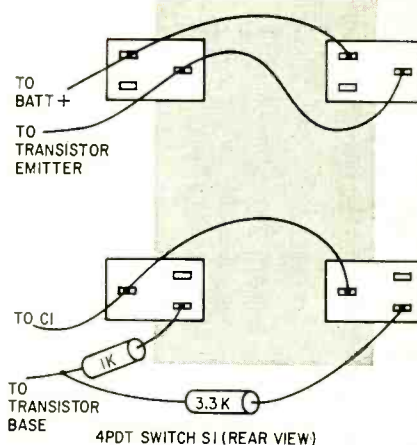

Fig. 3—Details of switch wiring.

complete all wiring. A 1/4-inch-thick foam-rubber pad cemented to the center of each cover will help keep the subassembly in place.

If you use the G-E lamp, you must short out the two series resistors which are built in for 60-cycle operation. Disassemble the lamp case and solder a length of bare wire across both resistors.

Troubleshooting

If the lamp fails to light or flash in either switch position, recheck the polarity of the transformer secondary leads. Improper connections or the wrong transformer will result in zero or, at best, unsatisfactory light output. As a last resort, try tapping the transformer secondary at a different spot. Although all of the several 6V6 transformers which were tried in this circuit worked best with the tap placed as shown, another type of transformer might require a different tap position.

Don't expect the concentrated brilliance of an incandescent lamp. The light output of an EL lamp is uniformly distributed over the entire lamp surface. Its soft, diffused glow illuminates a larger area and eliminates glare. After your eyes have become accustomed to darkness, you will find the EL nightlight as useful as a flashlight. In strong daylight, however, you may be unable to tell whether it is lit. If you have access to a brightness meter, measure the EL lamp's brightness. The original unit measured 1.5-2.0 foot-lamberts for the G-E lamp, and 1.0-1.5 foot-lamberts for the Sylvania.

The optimum value for R2 may vary slightly with the individual transistor used. If the lamp fails to flash in one switch position, try a larger value. R1 affects the current drain, light output and efficiency. R2 and C1 affect the flashing rate.

The completed EL nightlight is a useful camping accessory. Fishermen can use its distinctive flash to identify their dock at night. It makes a handy all-around emergency lamp. A set of batteries will work for more than 24 hours.

END

Bibliography

Electroluminescent Lamps, General Electric Co. Publication No. 3-0306, 1961

How Can You Use This Dramatic New Source of Light?, Sylvania Electric Publication No. P-I DR-859EY, 1959.

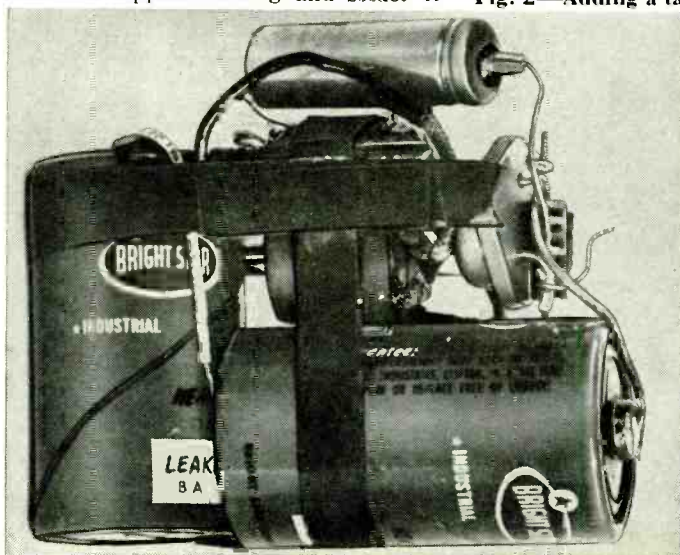

The wired assembly without the case.

FM stereo equipment roundup

The important dope on the FM stereo gear that has appeared since our October 1961 issue. By using this chart along with the directory in the October issue, you will have a complete comprehensive listing of all FM stereo equipment available today.

MANUFACTURER	MODEL	TYPE	MULTIPLY SECTION										DIMENSIONS (inches)	PRICE
			TUNERS IT WORKS WITH	OUTPUT VOLTAGE	OUTPUT IMPEDANCE	FREQUENCY RESPONSE (cycles)	HUM & NOISE (db)	38-KC SUPPRESSION	HOW MUCH SUPPRESSION (db)	SELF-POWERED	CHANNEL SEPARATION (db at 1000~)			
ABC ELECTRONICS 440 Beone St. Orlando, Fla.	611	Stereo Adapter	—	3.5	—	30-15,000	—	YES	—	YES	23	3 x 4 x 5	\$40.00 or less	
	600	Stereo Adapter	—	3.5	—	30-15,000	—	YES	—	NO	23	6 x 6 x 3	\$39.95	
	Knight KU-45	Stereo Receiver	NA	NA	NA	—	-75	NO	NA	YES	25	4 1/4 x 16 1/2 x 8 1/2	\$129.95 Kit	
	Knight-Kit KS-10	Stereo Adapter	75-Kc Bandwidth 0.3-1.5 V. Output	1	50,000 Ohms	50-15,000	-50	NO	NA	YES	25	3 1/4 x 4 x 9 1/2	\$19.95 Kit	
	Knight-Kit KF-30	AM-FM Stereo Tuner	NA	—	—	50-15,000	-60	NO	NA	YES	25	4 1/4 x 15 1/2 x 15	\$99.95 Kit	
	Knight-Kit KF-75	FM Stereo Tuner	NA	—	—	50-15,000	-60	NO	NA	YES	25	4 1/4 x 15 1/2 x 15	\$84.95 Kit	
ALLIED RADIO CORP. 100 N. Western Ave. Chicago 80, Ill.	Knight KN-141M	FM Stereo Tuner	NA	0.5	HI-Z	30-20,000	-40	YES	-25	YES	25	4 1/4 x 11 1/4 x 10 1/4	\$89.95	
	Knight KN-M X3	Stereo Adapter	100-Kc Bandwidth 0.4 V. Output	2.5	25,000 Ohms	50-15,000	-50	YES	-25	YES	25	4 1/4 x 5 x 7 1/4	\$44.50	
	355A	Stereo Adapter	At Least 0.1-V. Output	1	50,000 Ohms	20-15,000	-50	YES	-50	YES	30	5 1/2 x 5 1/2 x 7 1/2	\$89.50	
	520	Stereo Adapter	Low-Imped Output 0.24-2.4 V.	0-10	15,000 Ohms	50-15,000	-80	YES	-50	YES	30	12 1/2 x 4 1/4 x 4 1/4	—	
	MD-80	Stereo Adapter	100K Load .03-2 V. Output	0.3	2,200 Ohms	20-15,000	NONE	YES	—	YES	25	6 1/4 x 3 x 5 1/2	\$50.00 Approx.	
	MXA-614	Stereo Adapter	Almost All Tuners	Same as Input	—	50-15,000	-60	YES	-40	YES	30	5 1/4 x 5 1/2 x 9	—	
ALTEC LANSING CORP. 1515 S. Manchester Ave. Anaheim, Calif.	R-1103	AM-FM Stereo Tuner	NA	2	—	50-14,000	-55	NO	—	YES	—	13 x 4 1/4 x 12	\$119.95	
	MX-99	Stereo Adapter	Up to 5-V. P-P Output	Same as Input	1,000 Ohms	20-15,000	—	YES	—	YES	35	3 1/2 x 9 1/2 x 6 1/4	\$39.95 Kit \$64.95 Wired	
	3457M X	FM Stereo Tuner	NA	—	100,000 Ohms	50-15,000	-60	YES	—	YES	30	—	\$119.95	
	KM-60	FM Stereo Tuner	NA	—	—	20-15,000	-70	YES	-55	YES	35	15 1/2 x 13 x 4-13/16	—	
	MX-100	Stereo Adapter	Any Hi-Fi Tuner	15	3,000 Ohms	20-15,000	-70	YES	-40	YES	35	6-1/16 x 5-5/16 x 12 1/2	\$109.50	
	500-B	Stereo Receiver	NA	NA	NA	20-15,000	-60	YES	-55	YES	35	17 1/2 x 5 1/4 x 13 1/4	\$359.50	
ERIC ELECTRONICS 1823 Colorado Ave. Santa Monica, Calif.	800-B	Stereo Receiver	NA	NA	NA	20-15,000	-70	YES	-52	YES	35	18 1/2 x 7 1/4 x 14 1/4	\$429.50	
	FM-100-B	FM Stereo Tuner	NA	—	—	20-15,000	-70	YES	-65	YES	35	15 1/2 x 13 x 4-1/16	\$229.50	
	FM-50-B	FM Stereo Tuner	NA	—	—	20-15,000	-75	YES	-55	YES	35	15 1/2 x 13 x 4-1/16	\$189.50	

MULTIPLEX SECTION

MANUFACTURER	MODEL	TYPE	TUNERS IT WORKS WITH	OUTPUT VOLTAGE	OUTPUT IMPEDANCE	FREQUENCY RESPONSE (cycles)	HUM & NOISE (db)	38-KC SUPPRESSION	HOW MUCH SUPPRESSION (db)	SELF-POWERED	CHANNEL SEPARATION (db at 1000 cycles)	DIMENSIONS (inches)	PRICE
GROMMES 9101 King Street Franklin Park, Ill.	M-1	Stereo Adapter	MX Output Flat 50-55,000 cycles	0.5	HI-Z	30-15,000	-60	YES	-40	YES	30	4 1/2 x 4 1/2 x 9	\$59.95
HARMAN-KARDON Ames Court Plainville, N.Y.	Citation III F500X	FM Stereo Tuner FM Stereo Tuner	NA NA	3 3	1,500 Ohms 1,500 Ohms	2-20,000 20-20,000	-66 -60	YES YES	-50 -50	YES YES	45 30	14 1/2 x 6 x 12 1/2 15 1/2 x 4.5-7/16 x 12	\$239.90 Kit \$319.90 Wired \$169.95
HEATH CO. Benton Harbor, Mich.	GRA-21-1	Stereo Adapter	0.5-1.75-V. Output	Same as Input	2,000 Ohms	50-15,000	-	-	-	YES	20	15 x 8 x 6	\$49.95 Kit
KARG LABORATORIES 182 Ely Ave. South Norwalk, Conn.	MX-3 SCT-4 SXT-1	Stereo Adapter FM Stereo Tuner FM Stereo Tuner	0.25-2-V. Output NA NA	1 1.5 1.5	5,000 Ohms 10,000 Ohms -	30-15,000 40-15,000 30-15,000	-55 -48 -	YES YES -	-45 -45 -	YES YES YES	35 30 33	5 x 5 1/2 x 10 1/4 -	\$79.50 \$149.95 \$274.50
KENWOOD ELECTRONICS 212 Fifth Ave. New York 10, N.Y.	KW-60 KD-1	Stereo Receiver Stereo Adapter	NA 1-1.5-V. Output	- -	- -	- 50-15,000	- -60	- -	- -	YES YES	- 20	19 1/2 x 6 x 13 1/2 7 1/2 x 4 3/4 x 7 1/4	\$249.95 \$49.95
LAFAYETTE RADIO ELECTS 111 Jericho Turnpike Syosset, N.Y.	LT-200 LT-700 LT-300W X LA-445W X	Stereo Adapter FM Stereo Tuner FM Stereo Tuner Stereo Receiver	Most Late Model Tuners NA NA NA	1.5 1.5 1 NA	Low-Z Low-Z 15,000 Ohms NA	50-15,000 50-15,000 20-20,000 20-20,000	-50 -50 -60 -60	YES YES YES YES	-56 -56 -60 -60	YES YES YES YES	40 @ 400 cycles 40 @ 400 cycles 25 25	4 1/2 x 6 1/2 x 8 13 1/2 x 10 1/2 x 14 1/2 3 x 10 1/2 x 8 1/2 10 1/2 x 6 x 9	\$47.50 \$124.50 \$149.95 \$251.45
MOTOROLA INC. 9401 W. Grand Ave. Franklin Park, Ill.	HK54	Stereo Adapter	Flat to 53 Kc	1.5	100,000 Ohms	50-15,000	-60	YES	-40	NO	25	5 x 7 x 3 1/2	-
OLSON ELECTRONICS 260 S. Forge St. Akron, Ohio	RA490	Stereo Adapter	For Model RA-491 AM-FM Tuner Receiver	1.25	HI-Z	20-20,000	-30	-	-	NO	30	-	\$186.95 Tuner & Adapter
PAGO ELECTRONICS CO. 70-31 84th St. Glendale 27, N.Y.	MX-100	Stereo Adapter	Almost All Tuners	1	100,000 Ohms	15-15,000	-50	YES	38 Kc : -52 76 Kc : -85	YES	28	9 x 4 x 8 1/4	\$49.95 Kit \$69.95 Wired
PILOT RADIO CORP. 37-08 36th St. Long Island City, N.Y.	ST-35 MX 654M 280 380 602M 602S	FM Stereo Tuner FM Stereo Tuner FM Stereo Tuner FM Stereo Tuner FM Stereo Tuner FM/AM Stereo Tuner	NA NA NA NA NA NA	1 0.3 -1-2 0.3 0.3 0.3	100,000 Ohms 10,000 Ohms 10,000 Ohms 500 Ohms 10,000 Ohms 10,000 Ohms	15-15,000 20-15,000 20-15,000 20-15,000 20-15,000 20-15,000	-50 -50 Negligible Negligible Negligible Negligible	YES YES YES YES YES YES	38 Kc : -52 76 Kc : -85 -30 -30 -30 -30	YES YES YES YES YES YES	28 30 30 30 30 30	- 5 1/2 x 14 1/2 x 12 1/2 3 1/2 x 9 1/2 x 7 1/2 5 1/2 x 14 1/2 x 8 1/2 5 1/2 x 14 1/2 x 10 1/2	\$329.50 \$99.95 \$179.50 \$249.50 \$299.50
RADIO SHACK CORP. 730 Commonwealth Ave., Boston 17, Mass.	Realistic 214 Realistic 215 Realistic 230 335 LT-110	FM Stereo Tuner Stereo Adapter Stereo Adapter Stereo Tuner FM Stereo Tuner	NA Low-imped. Output 0.5-1.5 V. Low-imped. Output 0.2-2 V. NA NA	1 2 0.3 NA 2	5,000 Ohms 5,000 Ohms 100,000 Ohms NA -	20-20,000 50-15,000 40-15,000 20-15,000 20-15,000	-50 -60 -60 -60 -60	YES YES NO YES YES	-50-55 -35 NA -50 -50	YES YES - - -	35 20 20 35 35	15 1/2 x 5 1/2 x 1-1/16 7 1/2 x 4 1/2 x 6 4 x 3 x 5 -	\$149.95 Kit \$169.95 Wired \$239.95 Kit \$339.95 Wired
H. H. SCOTT, INC. 111 Powder Mill Road Maynard, Mass.	MX-P-2/MX-477	Stereo Adapter	20,000-ohm Imped. 0.5-2-V. Output	Same as Input	250,000 Ohms	-	-55	YES	-30	YES	26	8 1/2 x 4-5/16 x 2 1/2	\$39.95
V-M CORP. 305 Territorial Rd. Benton Harbor, Mich.	1441	Stereo Adapter	Output Less Than 2 V.	2	15,000 Ohms	50-15,000	-60	NO	NA	YES	25	2 1/2 x 10 x 3	-
WEGOR SALES CO. 5610 W. Bloomingdale Ave. Chicago 39, Ill.	A1945	Stereo Adapter	Most Good Quality Tuners	Same as Input	30,000 Ohms	-	-45	YES	-30	YES	20	7 1/2 x 5 x 3	-
ZENITH RADIO CORP. 6001 W. Dickens Ave. Chicago, Ill.	MH910	Stereo Adapter	Ordinary FM Radio	-	-	-	-	-	-	YES	-	9 1/2 x 13 1/2 x 7 1/4	\$89.95

NA—Not Applicable.
All data from manufacturers, specifications.

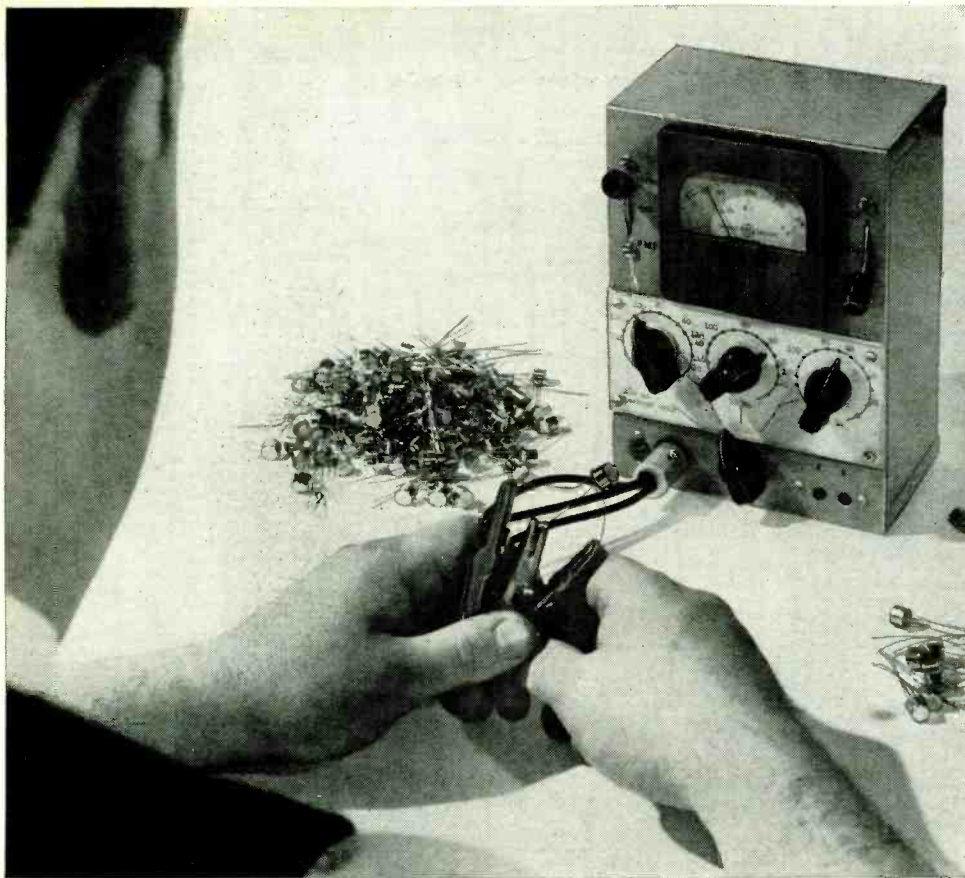

check tran- sistors 3 ways

- ▶ Are they good or bad?
- ▶ What's the leakage current?
- ▶ What's the beta?

By Capt. W. B. Bernard, USN, Ret.

Most of the simpler transistor testers use one fixed collector current. Because transistor beta may vary widely with collector current and because of the varying amounts of collector current which may be attributed to I_{CO} , such tests often do not give an adequate picture of the condition of the transistor under test. The unit described in this article tests transistors at currents ranging from 250 μ a to 100 ma. Although 100 ma is at the lower borderline for realistic power transistor testing, it was selected as the maximum current that could be used with a power supply consisting of three size-D flashlight cells. If portability were not a factor, an ac-operated supply or No. 6 dry cells would extend the current range up to 10 amperes.

The checker makes the three tests shown in Fig. 1. In Fig. 1-a it is connected to check transistor collector-to-base leakage (I_{CO}). A resistor in series with the circuit limits current in case the transistor has a short between collector and base. In Fig. 1-b the base is left floating and the meter measures collector-to-emitter current, with no external current applied to the base. We have to know this current to determine the amount of collector-current change when we supply current to the base through the resistor R in Fig. 1-c.

We are interested in the change of collector current since $\beta = \frac{\Delta I_C}{\Delta I_B}$. The collector current flowing with zero base current will often be negligible. So for the time being we will consider that $I_C = \Delta I_C$. Since no base current can flow except when the external circuit to the base is closed, $I_B = \Delta I_B$. With this simplification of terms, we can write:

$$\beta = \frac{I_C}{I_B} \quad (1)$$

Since the base-to-emitter voltage of a transistor is very small, we can say

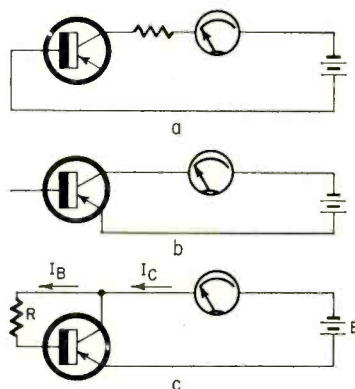

Fig. 1—The three basic checks made by the instrument: a—collector-to-base leakage; b—collector-to-emitter current with the base open; c—collector-to-emitter current with current supplied to the base.

with little error: $I_B = \frac{E}{R}$ (2)

Substituting 2 in 1 we have: $\beta = \frac{I_C R}{E}$ (3)

or $R = \frac{\beta E}{I_C}$ (4)

It is apparent from Equations 3 and 4 that, if E and I_C are held fixed in value, R and beta are directly related. We can make R in Fig. 1-c variable and calibrate the dial associated with it directly in the value of beta.

We will now assume that our meter has a full-scale sensitivity of 1 ma and that it would be most convenient to fix the value of I_C at half scale or 500 μ a. Since we are using three flashlight cells, we use 4.2 volts for E. Substituting these values in Equation 4 we have:

$$R = \frac{\beta \times 4.2}{500 \times 10^{-6}} = \beta \times 8,400$$

Using this relation we can calibrate the dial which controls the value of R with the proper values of beta for the conditions of $I_C = 500 \mu$ a and E = 4.2 volts.

Earlier we mentioned that a single value of collector current will not test all classes of transistors realistically. We can remedy this by shunting our meter so its full-scale sensitivity is 10 ma and reading beta at a collector-current value of 5 ma. Leaving E as 4.2 volts, we have $R = \frac{\beta \times 4.2}{5 \times 10^{-3}} = \beta \times 840$. Because of the factor of 10 change in the value of R for a given beta, it would

seem desirable to switch in a different variable resistor for R when we switch a shunt onto the meter. This resistor can be calibrated in beta for an I_c of 5 ma.

Now, shunting the meter so it has a full-scale sensitivity of 100 ma, we select a value of 50 ma for I_c . Calculating for this, we find that $R = \beta \times 84$. Again we can switch in a new variable resistor and calibrate it for values of beta corresponding to $I_c = 50$ ma and $E = 4.2$ volts.

The table is developed from these formulas and may be used to calibrate the three base resistor sets. If possible, this calibration should be done with a bridge to determine the resistance values. However, a good ohmmeter will do a satisfactory job.

So far we can measure the beta of our transistors at 500 μ a, 5 ma and 50 ma. Without too much trouble we can measure beta at half and twice these values of current, thus adding to the three values listed, 250 μ a and 1, 2.5, 10, 25, and 100 ma.

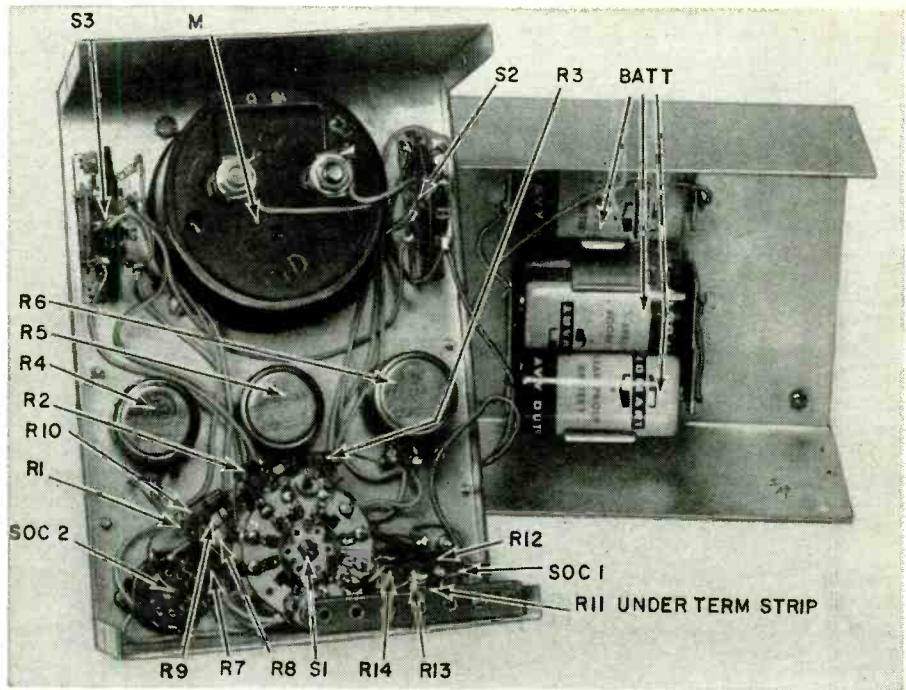

Suggested parts layout inside the case.

BETA VS. I_c RESISTORS

Beta	500 μ a	5 ma	50 ma
10	84 K	8.4K	840
20	168 K	16.8K	1,680
30	252 K	25.2K	2,520
40	336 K	33.6K	3,360
50	420 K	42 K	4,200
60	504 K	50.4K	5,040
70	588 K	58.8K	5,880
80	672 K	67.2K	6,720
90	756 K	75.6K	7,560
100	840 K	84 K	8,400
110	924 K	92.4K	9,240
120	1.008M	100.8K	10,080

measured to just below a value of 10. The maximum beta value that can be measured is about 125. At the $\times \frac{1}{2}$ setting of the meter, beta can be measured from values of 5 to 60 and at the $\times 2$ setting from 20 to 240.

R7, R8, R9 and R10 are the meter protector resistors which prevent meter overloading when leakage measurements are made on a shorted transistor. R12, R13 and R14 are the meter shunts used to set up the ranges of 100, 10 and 1 ma, respectively. R11 builds out the meter resistance to a value that allows

the use of standard resistance values for shunts.

The proper value of resistance in all the circuits is selected by S1. S2 selects the proper test-voltage polarity for n-p-n or p-n-p transistors. S3 selects the desired test function. When S3 is in the LEAK (leakage) position, the transistor emitter is open-circuited and the meter, battery and protective resistor are connected in series with the collector-base junction to measure the leakage across that junction. When S3 is in the ZERO position, the transistor

Let us refer to Equation 3,

$$\beta = \frac{I_c R}{E}$$

If we maintain R and E fixed, beta must change by the same factor as I_c . Therefore, if we leave our setup unchanged and set I_c at half the value we used in the calculations above, the beta of the transistor will be half the value we read off the scale on R. If we set I_c to twice the amount calculated above, beta will be twice the value we read off the scale. Since the division or multiplication can be done easily, we need only two more reference marks on the meter scale. Since we selected half scale for calibrating our resistors, we may label a mark at one-quarter scale "Multiply by $\frac{1}{2}$ " and a mark at full scale "Multiply by 2." Thus we can read beta at the additional current values.

To check collector-to-base leakage (Fig. 1-a), we need a meter sensitivity better than 1 ma. In this tester a 200- μ a basic meter movement is used for the most sensitive scale of leakage measurements. It is shunted for all beta measurements.

Fig. 2 shows the circuit of the tester. R4, R5 and R6 are the variable base resistors for the three current ranges. R1, R2 and R3 provide a fixed minimum resistance, so beta can be

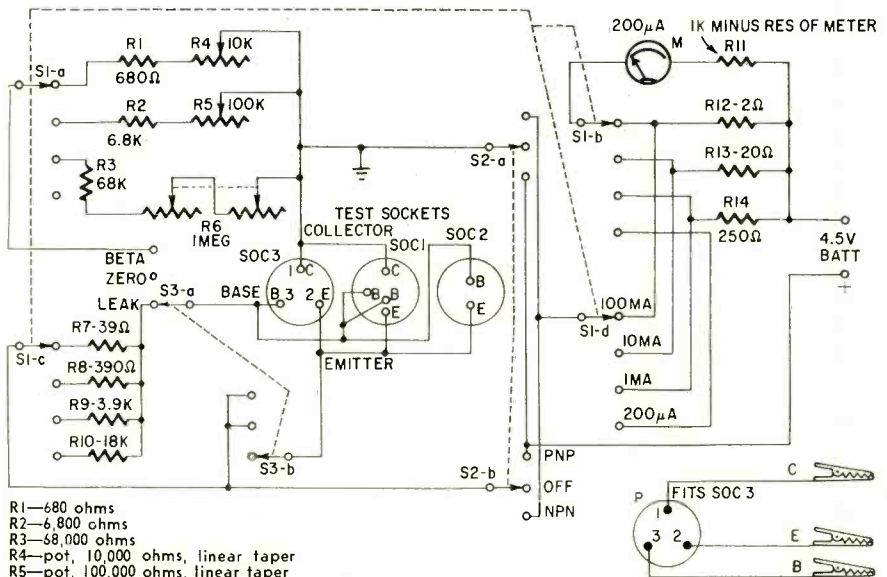

- R1—680 ohms
- R2—6,800 ohms
- R3—68,000 ohms
- R4—pot, 10,000 ohms, linear taper
- R5—pot, 100,000 ohms, linear taper
- R6—pot, 1 megohm, linear taper (see text)
- R7—39 ohms
- R8—390 ohms
- R9—3,900 ohms
- R10—18,000 ohms
- R11—1,000 ohms, minus the resistance of the meter movement. The meter I used has a resistance of 330 ohms, so I used 680 ohms for R11 (670 ohms was needed).
- R12—2 ohms (two 1-ohm units in series)
- R13—20 ohms (two 10-ohm units in series)
- R14—250 ohms (150 and 100 ohms in series)
- All resistors $\frac{1}{2}$ -watt 10%

- BATT—4.5 volts, 3 flashlight cells
- M—200 μ a dc, full scale
- P—3-contact male connector to match SOC 3
- S1—4-position, 4-pole, shorting rotary switch
- S2—3-position, 2-pole, shorting lever switch
- S3—3-position, 2-pole, shorting lever switch, spring return from beta position
- SOC 1—universal type transistor socket
- SOC 2—power-transistor socket
- SOC 3—3-contact female connector to match P
- Alligator clips (3)
- Case, 7 x 5 x 3 inches

Fig. 2—Circuit of the complete tester.

base is open-circuited and the meter and battery are in series with the collector and emitter terminals of the transistor. This measures the collector current with zero base current from the external circuit. With S3 in the BETA position, a base current equal to $\frac{E}{R}$ is supplied to the base so that the change in collector current caused by the base current can be measured.

Build it yourself

The tester was built into a 7 x 5 x 3-inch aluminum box. The beta calibrations were made on drawing paper protected by a thin sheet of transparent plastic. In addition to the calibrations, lines leading from the knob pointer positions of S1 indicate which meter scale is in use and which base resistor is connected into the circuit.

S2 is at the upper left of the front panel. In its center position, the battery and the meter are disconnected from

the rest of the circuit. In the upper position, the polarity of the circuit is set for testing n-p-n transistors. With S2 in the lower position, the polarity is right for testing p-n-p transistors. S3 is at the upper right of the panel.

At the bottom of the panel are three test sockets. The one at the lower right is for power transistors. At the lower left is a combination socket that takes either the in-line or semicircular arrangement of leads of small transistors. Between this small socket and the knob for S1 is a three-pin socket which accepts a plug connected to flexible leads terminated with insulated clips. These leads are used when checking transistors that cannot easily plug into the sockets. One of these leads is used as the collector connection for any transistor plugged into the power-transistor socket.

The interior of the instrument is relatively uncrowded and there are no particular problems in parts arrange-

ment. Batteries are mounted inside the bottom of the case and are arranged to clear S1 and the meter terminals.

A 1-megohm linear pot was not available for R6 during construction so I used a dual 500,000-ohm linear pot with sections connected as in the diagram. A 1-megohm linear single-section pot is preferable.

How to use it

To test a transistor, place S2 in the OFF position, S3 at LEAK and S1 on a scale suitable for measuring the expected leakage. Then plug in the transistor. Next move S2 to select the proper polarity of test voltage, and read the leakage current. If the meter needle goes off scale, move S2 to OFF immediately. An off-scale reading indicates that the transistor has a shorted collector-base junction or that the wrong polarity was selected for the test. Reversing S2 will determine if the polarity was set correctly in the first test.

If the leakage reading is normal, we are ready to measure the collector current that flows when there is no external base current. Set S1 to the desired beta scale and S3 to ZERO. If appreciable collector current is flowing under this condition, compared to the I_0 at which the test is desired, this zero current must be added to the desired I_0 reading so the change of I_0 is equal to the desired current. For example, if we have set the tester to test the transistor at 500 μ a and the zero current is 100 μ a, we must set the meter needle to 600 μ a for an accurate beta reading. A high zero current may prevent testing at the full-scale mark ($\times 2$) on the meter. In this case, add the zero current to $\frac{3}{4}$ of the full-scale reading of the meter and multiply the reading by $1\frac{1}{2}$.

Having decided at which current, on the selected scale, we are going to test for beta, set S3 to the BETA position, read the scale under the pointer of the proper R knob, and multiply by the value indicated on the meter face.

The 4.2 volts supplied by the batteries was selected as low enough to test all the transistors commonly listed in the catalogs, yet high enough to saturate most power transistors. An external supply can be inserted in series with the collector lead to raise or lower the voltage if we want to test at other than the conditions available within the tester. So long as the internal supply voltage is not changed, beta readings on the instrument face will remain correct.

Check diodes for leakage by connecting them between the base and collector clips, setting S3 at LEAK and selecting the proper polarity with S2. You can get a rough idea of the forward conduction of the diode by reversing the polarity of the applied voltage with S2.

Information for setting up the tester for a given transistor type is best obtained from manufacturers' data sheets. However, the data given in mail-order catalogs will, in many cases, give enough information for meaningful tests. Be careful not to exceed any of the transistors' limiting factors—voltage, current and power dissipation. END

improving inexpensive amplifiers

By R. C. SANDISON

HERE ARE THREE SIMPLE STUNTS, USING junkbox parts, which will very noticeably improve the overall sound and extend the range of a medium-fidelity amplifier somewhat in both directions.

A circuit similar to Fig. 1 was used in some Philco models over 20 years ago. The sound from these ancient sets, though limited in range, compares favorably with many modern amplifiers. The original circuit used a tapped field coil plus a choke, but the choke alone works equally well when inserted directly into the screen feed line.

The special feature is the improved clarity and "cleanness" of the middle frequencies, which makes the circuit especially valuable in PA systems intended primarily for voice reproduction.

The value of the choke is not critical. If you have an impedance bridge, pick a choke whose value is between 20% and 30% of the output transformer's primary impedance. If you have only an ohmmeter, choose a choke with a quarter to a half the primary's dc resistance.

If possible, try two or three chokes of various ohmages, listening carefully to spot the one giving the best results.

Because of the comparatively small screen currents, any small ac-dc choke will do, or you may be able to use the primary of a midget output transformer.

Fig. 2 shows an old (easy but seldom used) way of increasing the inductance of any output transformer. B-plus current is removed from the primary and fed through a center-tapped choke to plates and screens. (Of course, this may be combined with Fig. 1, by using a second choke in the screen feed.) This does away with any possibility of dc saturation and will give considerably better reproduction than the transformer alone. Bass response is especially improved, often by several decibels.

The impedance value of the choke is not critical. The primary of almost any push-pull output transformer can be used, and I have even used the high-voltage winding of small power transformers. A 2- μ f capacitor in each of the plate leads is ordinarily enough, although you might like to try values as high as 4 μ f.

If your amplifier employs a phase inverter or other interstage transformer, you can still improve matters by removing dc from its primary. Just couple the plate to the transformer (Fig. 3) through a .01- to .05- μ f capacitor and feed the B-plus separately through about a 200,000-ohm resistor. The exact value depends on the circuit and especially the tube used. END

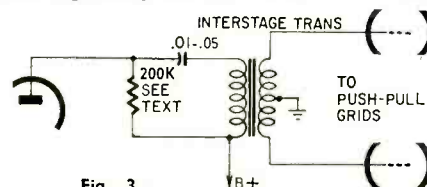
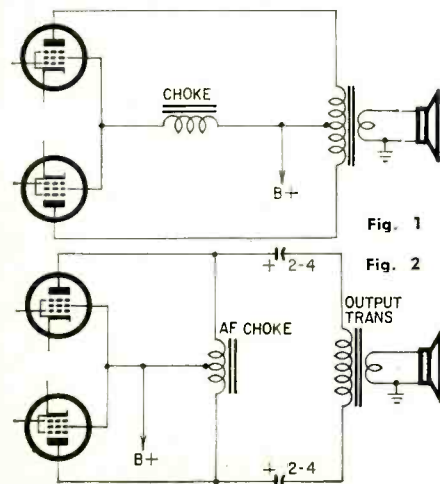

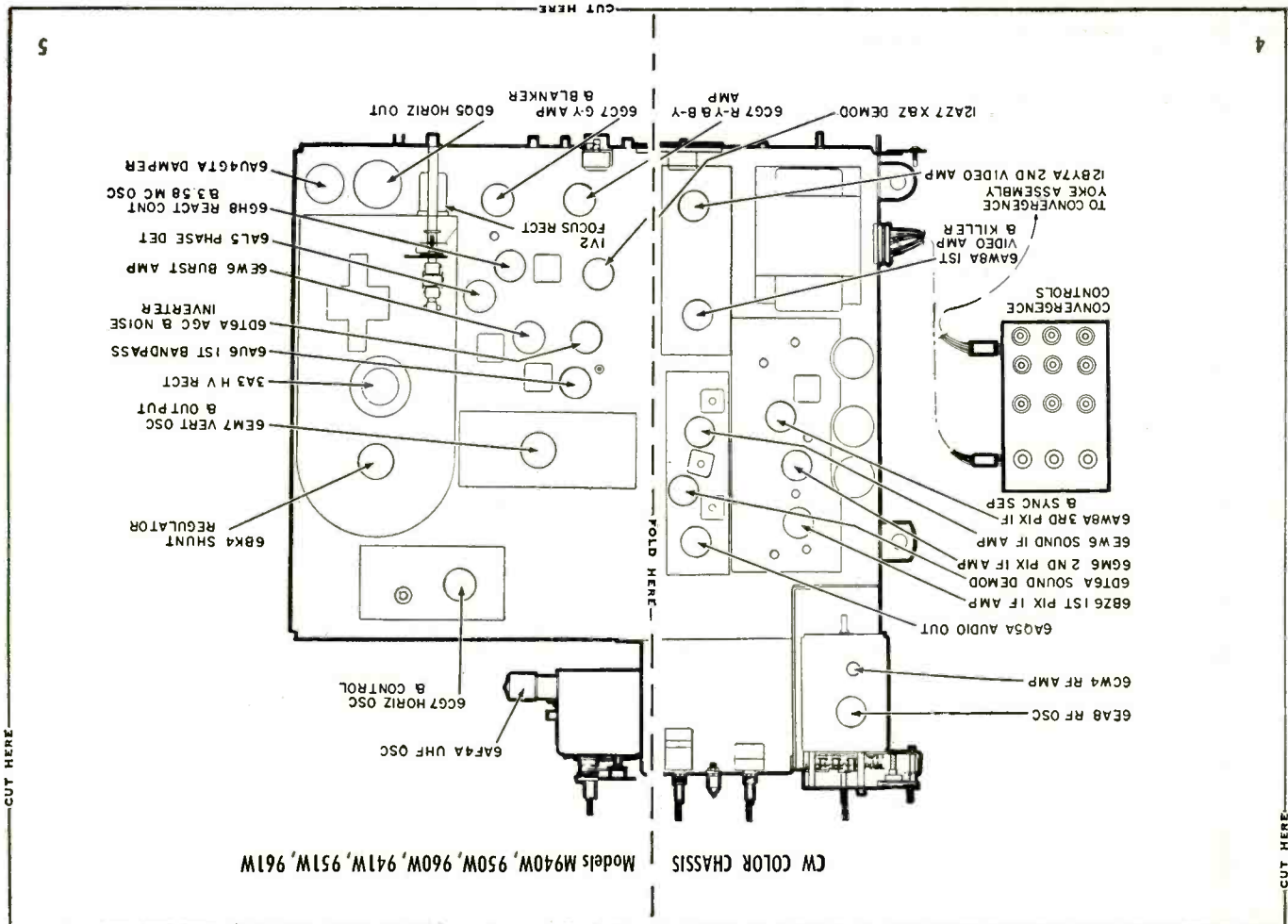

Models M940W, 950W, 960W, 941W, 951W, 961W CW COLOR CHASSIS

TRIM HERE AFTER FOLDING

LW CHASSIS Models M202, 3, 4, 5

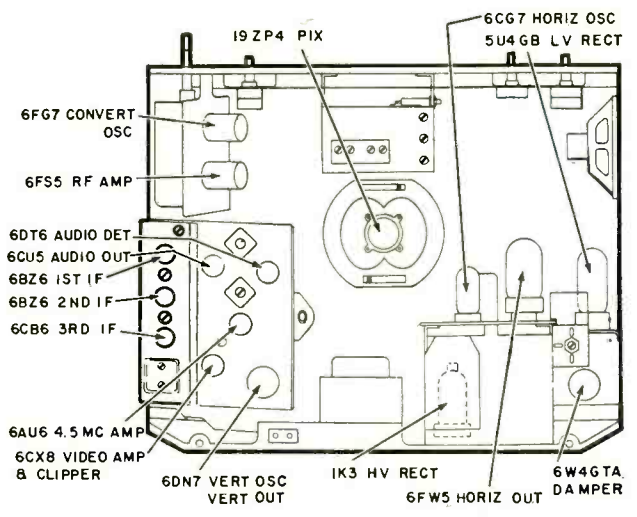

HOW TO FOLD

Fold the top down and back, keeping the cover facing you. Then fold from left to right on the line marked fold here, keeping the cover facing you. Staple the booklet along the left-hand edge. Now run a sharp knife or razor blade along the closed top and you're finished. You now have another useful piece of service data, exclusive with RADIO-ELECTRONICS.

Radio-Electronics

TUBE LAYOUTS IN TV SETS

Compiled by Larry Steckler, Associate Editor

GENERAL ELECTRIC
1961-1962

SERVICING

CB transistor transceivers

How to handle these units profitably

By **LEONARD E. GEISLER***

Large numbers of pocket-sized all-transistor CB transceivers are in every-day use. At one time or another, every one of them will be brought to a service technician for repairs. Are you ready for such repairs? This article will show what is needed to repair these sets and what basic steps to take while servicing.

The first thing a technician must have is an FCC First or Second Class Radiotelephone license. *Without one, you are not authorized to do any work on the transmitter section of the unit; at least nothing that really counts.*

Second come instruments:

▶ A good standard signal generator, well shielded, with μ v attenuator. It should tune from 100 kc to 30 mc.

▶ BC-221 heterodyne frequency meter or unit with equivalent accuracy.

▶ Simple field-strength meter.

▶ CB crystal checker, if available.

▶ Oscilloscope. One with access for

direct connections to the vertical deflection plates of the CRT.

▶ 20,000 ohms-per-volt vom with standard and needle prods.

Third come the hand tools:

▶ Long-nose pliers (4-inch).

▶ Duckbill pliers (4-inch).

▶ Diagonal cutters (4-inch).

▶ Magnifying eyeshade or other magnifying device.

▶ Set of watchmaker's screwdrivers.

▶ Assorted tweezers.

▶ Alignment tools—nylon or hard fiber.

▶ Low-wattage soldering iron, preferably with a $\frac{1}{4}$ -inch tip.

Troubleshooting procedures

When a set comes into your shop, quiz the customer, note his description of trouble. Then, while he watches, check the set for loose, dead or improperly inserted batteries. Eliminate this common cause of trouble right at the start.

Now that you know the set really needs repair, you'll have to hunt around till you find the combination and get the case open. The set I use as an example has a single closure screw located

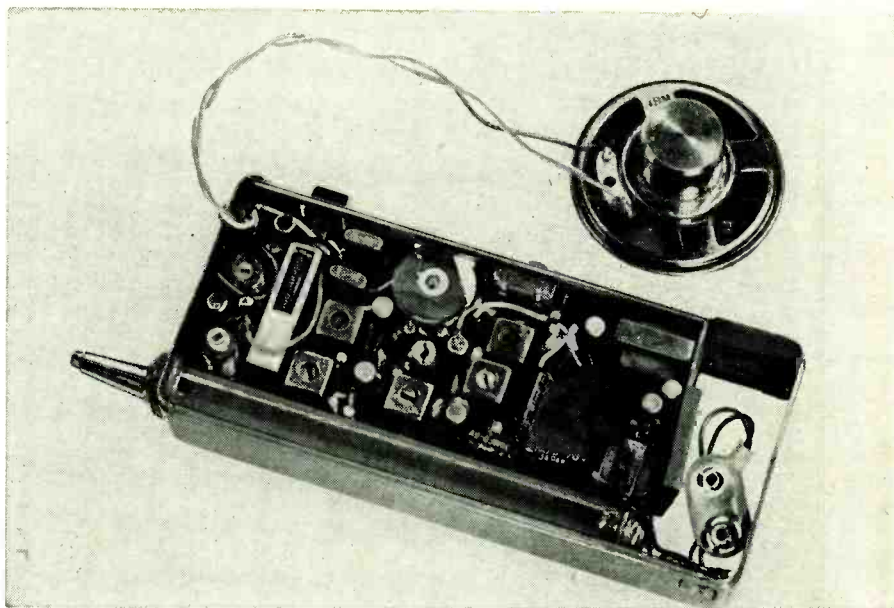

Typical transceiver with cover removed. Note compactness of layout.

under the trademark-cum-pocket clip—a special offset screwdriver must be used. Once you have the case open, what do you look for?

Most troubles are the result of ordinary wear and tear, but some are caused by improper or careless use of the equipment. Remember these units are very portable and it isn't unusual to get one that has taken a bath or been dragged through the mud on a hunting trip.

Inspect each set carefully. Look for components that have broken loose, broken leads, cracks in the printed-circuit board, and drool from dead or over-age batteries. Sometimes a small piece of metal or a wire clipping will find its way into the case and short out the set. Blow out all the pocket fuzz and dust. You'll repair a few sets this way.

If inspection reveals no visible faults or if components are mounted

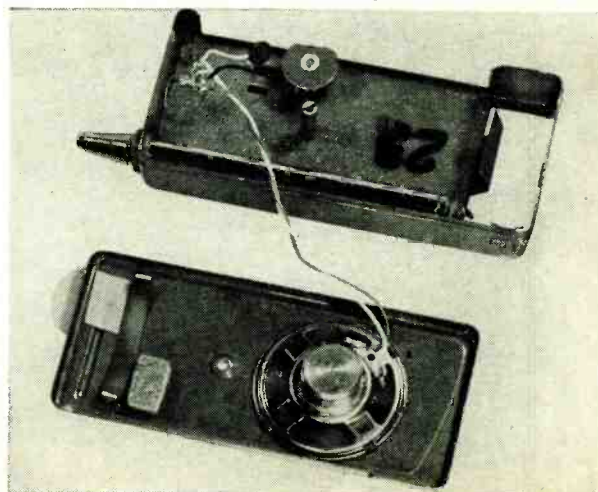

View of the transceiver minus most of the components shows location of mounting screws and phone jack which must be removed before taking out the printed-circuit board.

*Applications engineer, Apollo Electric Industries, Ltd., Tokyo, Japan.

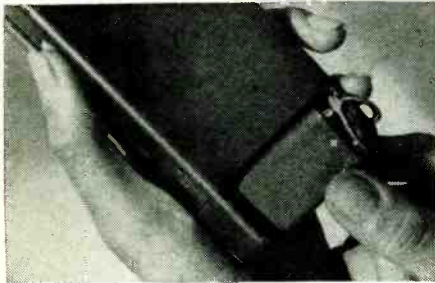

Even battery replacement can be tricky. On this set first you must remove the cover on the battery compartment. Then lift out battery and replace.

under the printed circuit board, your next step is to remove the chassis (printed circuit) from the set. This takes careful handling. These boards are fastened in place in two or more spots. If you don't get all the fasteners loose before applying pressure to the board, you may end up with a two-piece P-C board. So work carefully and never apply more than moderate pressure while trying to remove the chassis.

Puzzling troubles are to be expected. When you get the case open, you may find that the set works again. Yet when you close it up, it stops operating. For example, there's one set that has a pocket clip with two spring-retaining legs that fit through the front of the case. A heavy-handed operator can force the clip down enough to short the antenna. The solution to this problem, once it is located, is to clip off a small piece of the offending leg and stick a piece of electrical tape onto the antenna to prevent further shorts.

Keeping the heavy-handed customer in mind, look for mechanical failure throughout the set. Push-to-talk switches don't last very long if the

operator applies too much pressure. In some sets the switch won't break, but the shaft will bend. Straighten it and tell the operator what happened and why.

Check the volume control too. It may have been forced past the limit of its rotation. Occasionally someone leaves batteries in the set a little too long and leakage finds its way onto the foil of the P-C board. This can cause shorts between or corrosion of the thin foil conductors. After removing the defective batteries, clean the board with radio solvent applied with a cotton swab. Then flow solder over the damaged foil to build up its thickness.

If a set has been exposed to extremes of temperature, look for dried-out electrolytics first. As a rule, the transistors will not fail because of extremely high temperature, but it could happen. Check the transmitter output transistor in particular.

Receiver alignment

If you've never aligned a transistor receiver, keep in mind that they do not take kindly to inputs greater than about 500 μv . A block diagram of a typical unit is shown in Fig. 1. So keep the signal-generator output low! Better still, use the CB crystal checker (it checks crystal activity) and the set's own transmitter crystal as a source of alignment signal. Place the crystal checker close to the transceiver so you can hear its output and keep backing the checker farther away as the alignment brings up the sensitivity of the set. Be extra careful not to align to the image frequency. To check this, listen to a known good set on the same channel the repair job is on and make sure you're receiving the same station on both sets at the same time.

Multiple-conversion superhets call for extra care in alignment as it is possible to tune the second mixer to an image of the first mixer's i.f. or vice versa! This will result in puzzling images and reduced sensitivity until the trouble is located and the set retuned.

When aligning the i.f. transformers, disable the local oscillator by shorting the oscillator coil or pulling the oscillator crystal. For accurate output indication and best alignment, hook the vtm's dc probe to the emitter of the first i.f. transistor and tune the i.f. transformers for *minimum* voltage across the emitter resistor to the common battery return line.

Should an i.f. transformer have to be replaced and you think you have the exact—or nearly exact—replacement, check all the other i.f.'s in the set for proper connections. Should the new transformer refuse to align properly, with the set oscillating or motorboating, the transistor ahead of the transformer may be improperly impedance-matched and will have to be neutralized.

To neutralize an i.f. stage, remove the existing neutralizing capacitor, if any, and replace it with a slightly smaller value, shunting it with two lengths of insulated hookup wire twisted to form a "gimmick." Adjusting the

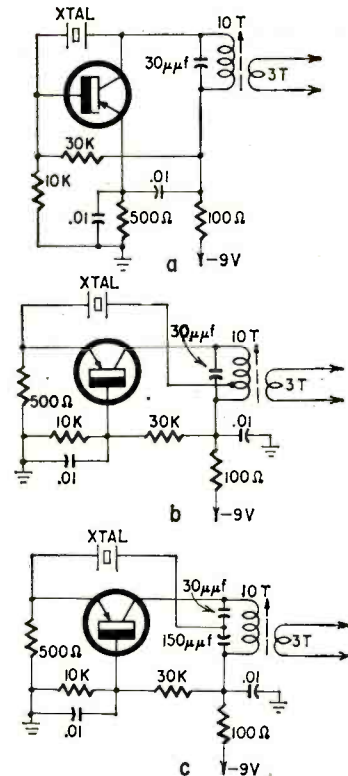

Fig. 2—Three basic CB transceiver oscillator circuits. a—Grounded-emitter "Pierce". b—Grounded-base, collector-emitter feedback. c—Grounded-base "Colpitts". By replacing the 100-ohm resistor to the -9-volt supply with a modulation transformer, any of these stages could be used as a modulated oscillator.

gimmick usually cools off the stage enough to permit successful alignment. To make doubly sure that the set is "cool," always apply slightly higher battery voltage than the nominal battery supply. Some fresh 9-volt batteries measure 10 volts under load and a hot i.f. string will really take off.

Remember that an accurately calibrated signal generator is a must for accurate channel calibration!

Transmitter tuning procedures

WARNING! DO NOT TUNE THE TRANSMITTER OSCILLATOR UNLESS YOU HOLD A FIRST- OR SECOND-CLASS RADIOTELEPHONE LICENSE!

Tuning up a CB transmitter without a valid FCC phone ticket in your possession could result in legal action against you or the set owner.

Most transmitters are relatively simple. However, an occasional complex neutralization circuit or impedance-matching circuit is found.

Alignment of the transmitter oscillator is generally not necessary unless the owner requests a channel change. Three transceiver oscillator circuits are shown in Fig. 2. If only one or two channels difference is involved, no tuneup may be necessary. For a change from, for example, channel 2 to channel 20, repeaking the oscillator and final tanks will be necessary. Use the heterodyne frequency meter to check the transceiver oscillator for exact alignment. The

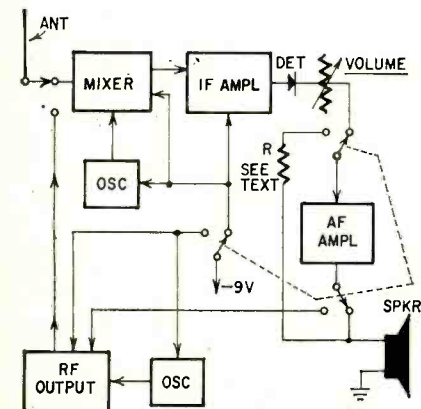

Fig. 1—Generalized block diagram of typical CB transceiver.

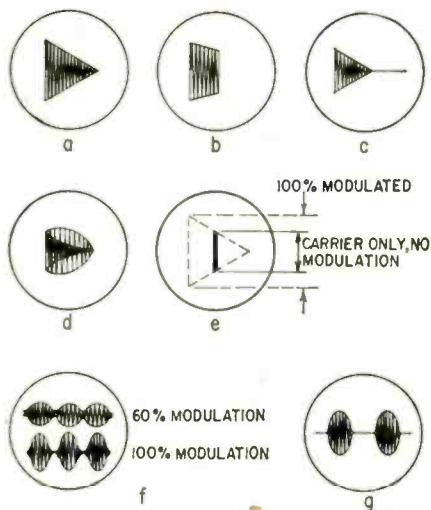

Fig. 3—CRT patterns seen using the test setup of Fig. 4. When scope is fed only rf and sweep is applied to horizontal plates, the modulation envelope can be seen clearly. a—100% modulation. b—60% modulation. c—Over-modulation. Carrier clipping. d—Phase shift in audio. e—Carrier only. No modulation. f—Undistorted waveforms of (a) and (b) using horizontal oscillator to scope CRT. g—Overmodulation, about 200%.

article "Using the BC-221 to Check CB Frequency" (*Electronics World*, May 1961) describes a method of using this instrument to check CB frequencies to within $\pm .0025\%$.

If the output of the transmitter has fallen off and you feel that alignment will bring it back up, it is quite easy to do this job. Simply set the field-strength meter about 18 inches away from the CB set and, using a fiber or nylon screwdriver, tune the final tank slug (or capacitor) until the field-strength meter shows a maximum read-

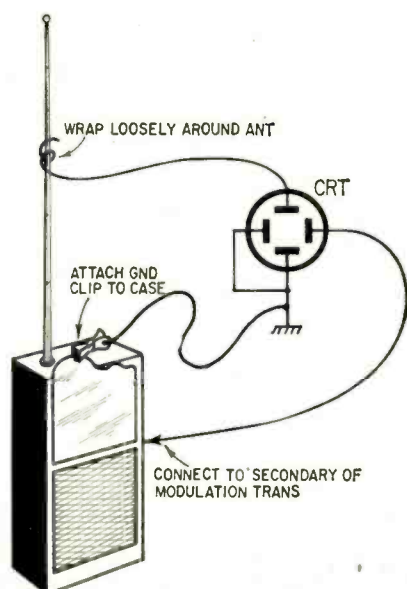

Fig. 4—Simple modulation check setup. Transceiver case must be grounded to scope.

Troubleshooting and Repair Hints

Symptom	possible troubles—repair
Set dead, no sound or transmitter output	Check battery. Replace if output low on open circuit. Locate circuit breaks and repair. Volume control may have been damaged by overrotation. Replace. Operator may have inserted battery backward. Reverse.
Receiver OK. Transmitter dead.	Push-talk switch damaged. Replace. Loose crystal or oscillator tuning slug may have dropped out. Reinsert slug. Antenna shorted. Check and clear. Antenna lead broken. Repair.
Receiver OK. Transmitter has only carrier output, no modulation.	Mike (or speaker) lead loose. Locate and repair. Push-talk switch damaged. Replace. Operator not depressing switch all the way. Instruct operator.
Receiver OK. Transmitter audio sounds gravelly or scratchy with background noise mixed in.	Loose crystal or oscillator tuning slug may have dropped out. Reinsert slug. Open bias resistor or emitter resistor in oscillator circuit. Replace. Bypass capacitor may have changed value. Replace.
Receiver and transmitter sound distorted.	Check battery. Replace if output low on open circuit. Main filter capacitor dried out. Replace. Audio transistor bias or emitter resistor changed value. Locate and replace. Inspect for cold-solder joints. Repair. Bad transistor in audio stages. Replace. If bad unit is one of two in push-pull output stage, replace both.
Receiver OK. Transmitter output weak.	Antenna shorted. Check and clear. Battery weak, OK for receiver but not transmitter. Replace. Antenna not fully extended. Operator touching antenna during transmission. Operator allows antenna to touch something during transmission. Set too far off vertical.
Transmitter OK. Receiver dead.	Check battery supply to rf and i.f. sections. Also check decoupling resistors. Replace defective components. Repair open circuits. Inspect bypass capacitors. Replace defective units. Check detector diode with ohmmeter. Replace if front-to-back ratio less than 10:1. Check all i.f. transformers with ohmmeter. Replace defective units. Push-talk switch spring weak and switch hangs up in transmit position. Inspect and repair.
Transmitter OK. Noise audible from speaker, but no reception.	Local oscillator incorrectly peaked. Retune.
Transmitter OK. Receiver sensitivity low.	Battery weak. Replace. Receiver antenna input coil not peaked properly. Retune. !.f. transformers not peaked correctly. Retune.
Mechanical damage. Obvious and unseen.	Inspect set carefully. If obviously caused by improper use or willful disregard of operating instructions, instruct operator carefully. Stress that fault will recur if operating procedure is not changed to conform with manufacturer's instructions.

ing. If there is an antenna loading-coil adjustment, touch it up after tuning the tank.

After all tuning is done, the input to the final must not exceed a total of 100 mw. If final input power is too high, detune the final tank slightly until the FCC limit is met. The transmitter will still function satisfactorily. If the transmitter cannot be brought within FCC limits, increase the value of the oscillator emitter resistor by 10% or 20% to

drop final drive power enough to meet the limits.

To make sure that the transmitter is modulating properly, see the waveforms shown in Fig. 3 and the setup in Fig. 4. For more complete information on modulation patterns, you'll probably find the ARRL Handbook an excellent guide.

Assuming you've got your modulation analyzing system set up, whistle into the CB transceiver microphone (or

speaker) and observe the scope pattern. It should be a sharply defined horizontally oriented triangle. If the triangle is not a triangle but a "lazy" pyramid with its top cut off, you are not getting 100% modulation. If the triangle has a horizontal line spread from its point outward, you may be overmodulating. A loopy-appearing pattern indicates either phase shift in the monitor hookup or in the set's audio circuits.

Note that overmodulation is

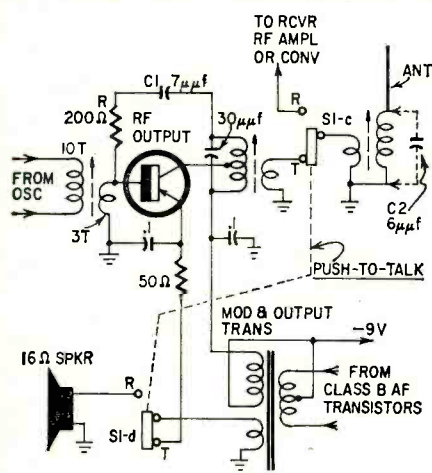

Fig. 5—Typical output stage of a transistorized CB transceiver. Note similarity to circuit of i.f. amplifier (ignoring the modulator transformer). Network R, C1 is needed to prevent transmitter parasitics. C2 is stray capacitance.

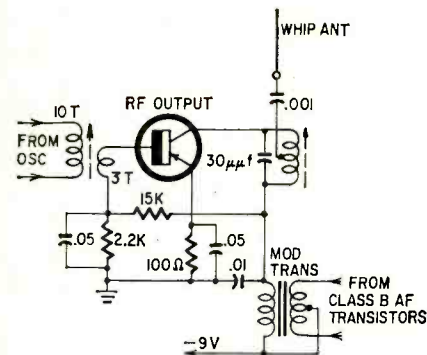

Fig. 6—Another transmitter final. Circuit is susceptible to thermal runaway, parasitics and spurious emission.

frowned upon by the FCC, even with flea-power rigs. Should it be difficult to reduce the gain of the transceiver modulator, insert a fixed resistor (cut and try for the best value) in series with the microphone line to the modulator driver—around 100 ohms would be a good starting value. Two transceiver output stages are shown in Figs. 5 and 6.

Final checkout

Having fought your way through the set, double check for unfinished business and button it up. Install the proper type of battery, check that the set still functions properly while in the shop, that the field strength has not fallen off when the metal case is closed. Then as a final check try the set out over several hundred yards to make sure it functions well. If it works OK, you can be reasonably sure you're finished. **END**

SW PROPAGATION FORECAST

March 15–April 15

By STANLEY LEINWOLL†

During the spring and fall months the sun is directly overhead in equatorial regions and illuminates the Northern and Southern hemispheres equally. As a result, the number of hours during which daylight and darkness occur at the same time in both hemispheres is at a maximum.

Since propagation of short-wave radio signals is best over all-daylight or all-dark paths, openings between the hemispheres occur for longer periods of time than at any other season.

This is particularly true of antipodal paths (to the "other side" of the earth). For example, openings from the east coast of the US to southeast Asia, and from the west coast of the US to South Africa occur for the longest periods of time.

This will happen primarily in the 15-mc band when the transmitter and receiver are in daylight, and in the 6- and 7-mc bands when both terminals are in darkness.

With the continued rapid decrease in sunspot activity, the 15- and 17-mc bands are expected to be best during the daylight hours, while the 6- and 9-mc bands will be optimum at night.

The tables show the optimum broadcast band, in megacycles, for propagation between the locations shown during the time periods indicated.

These tables are designed to serve primarily as a general guide for the listener, since day-to-day variations in receiving conditions can be considerable, particularly during disturbed radio conditions. At certain hours, propagation over some of the paths given in the tables may be extremely difficult, and stations heard over these circuits at these hours probably are utilizing very high power and high gain antennas.

EASTERN US to:

	Mid	2	4	6	8	10	Noon	2	4	6	8	10
West Europe	6	6	6	15	15	17	15	11	9	6	6	6
East Europe	7	6*	6*	11	15	15	15	11	9	7	7	7
Northern Latin America	9	9	9	9	15	17	15	15	15	15	6	6
Southern Latin America	9	9	9	11	15	15	15	15	11	9	9	9
Near East	7	7	7*	9*	15	17	15	11	11	7	7	7
North Africa	6	6	6	11	15	15	15	15	15	9	7	7
South & Central Africa	7	7	7	11	17	17	15	15	11	11	11	7
Far East	7	7	6	9*	9	7	7*	7*	7	11	11	9
Australia & New Zealand	9	9	9	9	9	9	9*	17*	21	21	15	11

CENTRAL US to:

West Europe	6*	6*	6*	15*	15	17	17	11	9	7	6	6
East Europe	7	6	6*	15	15	15	15	9	7	7	7	7
Northern Latin America	9	9	9	11	17	15	15	15	11	9	6	6
Southern Latin America	9	9	9	11*	15	15	15	15	11	9	9	9
Near East	7	6	6*	15	17	15	11	9	9	7	7	7
North Africa	6	6	6*	15	15	15	15	11	9	9	7	7
South & Central Africa	7	6	6*	11	17	17	17	11	11	11	11	9
Far East	7	6	6	6	7	7*	7*	9*	17	15	11	9
Australia & New Zealand	11	11	9	9	9	9	17	17	17	17	15	11

WESTERN US to:

West Europe	6	6*	6	15	15	15	11	9*	7	7	7	6
East Europe	6	6*	6*	15	15	9	9	7	7	7	7	7
Northern Latin America	9	9	9	15	15	15	15	15	11	9	9	9
Southern Latin America	9	9	9	15*	15	15	15	15	11	9	9	9
North Africa	6	6	6*	15	15	15	11	9	7	7	6	6
South & Central Africa	7	7	7*	11*	17	17	11	11	9	7	7	7
Far East	7	7	6	6	7	7	7	15	17	17	15	9
South Asia	6	6	6	6	9	11*	11*	9*	9*	15	11	9
Australia & New Zealand	11	11	7	9	9	15	21	21	21	17	17	15

†Radio-frequency and propagation manager, RADIO FREE EUROPE.

*Reception may be very poor or impossible on this path at this hour.

YOU

can set up COLOR

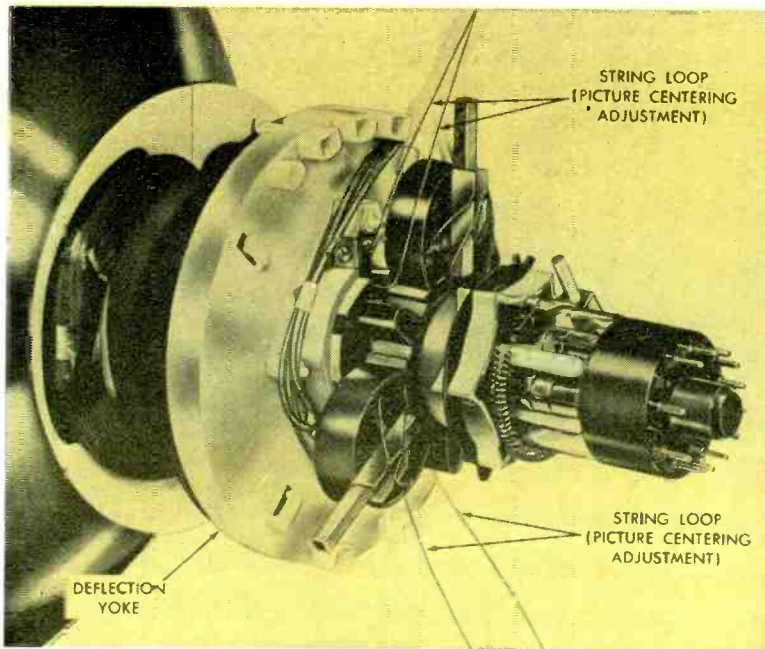

Convergence assembly on the neck of the Zenith color picture tube.

By WAYNE LEMONS

YOU'RE GOING TO BE SEEING MORE AND more color in the next year or so. The big push is just beginning and you'll want to share in the profits. So, you must become familiar with color receivers and know how to adjust them.

With new color tubes and closer chassis tolerances, plus many refinements, all you *may* have to do with a new color set is to demagnetize the picture tube and explain tuning in the color picture to the customer. Some sets, though, will require more elaborate adjustments.

First, let us caution you not to be overly critical. At close range, almost any color set will have minor contaminations, which are invisible at normal viewing distances. The customer who insists on no color contamination at all in the black-and-white picture at a range of less than 3 or 4 feet from the picture just isn't ready for color!

Before beginning any adjustments, read these hints:

1. When adjusting a set, move it straight out from the wall. Do not rotate it.

2. The quality of the color picture depends on the black-and-white quality. Do not try to evaluate a color program until you have made all the black-and-white adjustments.

If the set is badly out of adjustment, the worst condition should be corrected first, before the full setup procedure is started. This will eliminate back-tracking later on and may show up any bad convergence components.

4. It is faster and more accurate to run rapidly through the vertical and horizontal convergence adjustments several times, rather than one slow and careful time. Observe the sequence, but do it several times.

5. Only the reactance coil and the "tint" coil may be adjusted without

This article covers the practical angles of installing and setting up the Zenith and RCA color receivers. A story in February described the circuitry of the new Zenith TV and compared it with the RCA color set.

test equipment. All if and bandpass transformers should be left **STRICTLY ALONE!** *Nobody can adjust if's or bandpass correctly without complete alignment equipment. Any attempt will just make matters worse!*

Preliminary set-up procedure

Remove the back and mount the convergence subchassis on the screws provided for it at the rear of the cabinet. Plug in the power cord and hook up the antenna. Tune in a station and adjust vertical hold, horizontal hold, fine



Adjusting height control inside contrast-control shaft.



Degaussing set before starting color setup.



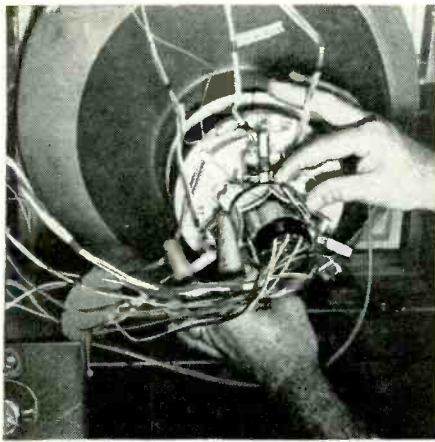

Rotating purity-magnet tabs.

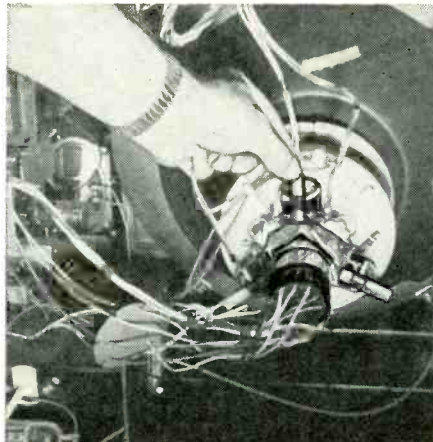

Adjusting blue dc convergence magnet.

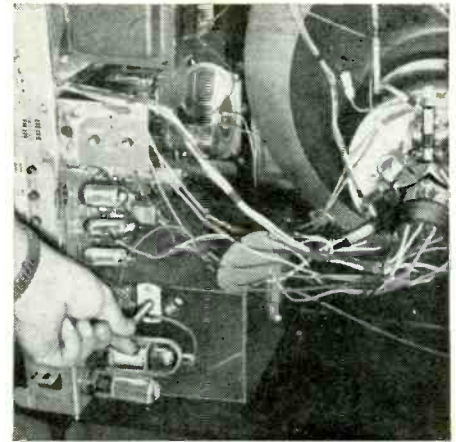

Focus adjustment is easy to get at.

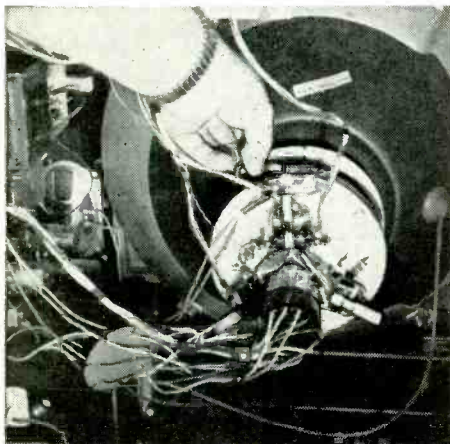

Width adjustment calls for connecting jumper wire on yoke. This adds a 47- μ f capacitor across the yoke.

tuning, etc., just as with black-and-white sets. Adjust the height and linearity for about a 1-inch overscan at both top and bottom, with good linearity. (Height and linearity are inside the contrast and tone controls on RCA sets.) Vertical centering on RCA sets is a pot on the rear chassis apron. Magnet ring adjustments manipulated by strings coming out of the yoke are used for centering on Zenith sets.

Using a black-and-white picture, adjust focus for best detail.

Adjust the horizontal centering for a centered picture with about $\frac{1}{2}$ to 1 inch overscan on the sides. If the picture needs widening, connect the attached jumper to connect an extra 47- μ f capacitor across the yoke.

You normally will not have to adjust agc since it is factory-set. However, if overloading occurs, you may have to move the control slightly.

Purity adjustments

Impurity is when, with only one color gun on, one or more other colors appear on the blank screen. The first cure to try is a degaussing (demagnetizing) coil. Move it about the face of the tube for a few seconds then remove the coil about 6 feet from the set and turn it at right angles before turning it off. This prevents a magnetic "set" caused by the collapsing field.

If the impurity is still there, turn down the blue screen. Center-converge the red and green fields by sliding the dc convergence magnets in their holders on the convergence yoke. Now turn up the blue and center-converge, using both the sliding magnet and the blue lateral magnet. The blue lateral magnet looks something like an ion-trap magnet on a black-and-white set but do *not* move the whole assembly like an ion trap! Simply rotate the magnet in its holder.

Now examine each color individually for possible impurities. If all three colors are pure at this point, you may go on to tracking adjustments. If the fields are still not all pure, turn on the red and turn down blue and green. Loosen the yoke clamp. Move the deflection yoke back against, but do not disturb, the convergence yoke, being careful not to tilt the deflection yoke.

Adjust the two purity magnet rings (they resemble the positioning rings of black-and-white sets) to bring the red area to the center of the picture tube. Now move the yoke slowly forward to where there is best red purity, especially at the edges of the screen, and tighten the yoke clamp. Again readjust the purity rings for a pure red field. Recheck center convergence and check each color for purity. If necessary, repeat yoke, purity-magnet and center convergence until you have *perfect* purity on all three colors.

Special note: Purity must begin and end with good center convergence. If impurity occurs on opposite sides of

the raster, adjust the deflection yoke. For impurity on one side or in the middle, adjust the purity-magnet rings.

Screen color and tracking

1. Slide the NORMAL - SERVICE switch to SERVICE position (see Fig. 1 for location on rear of chassis). This disables the vertical circuit and you see a single horizontal line whose brightness is unaffected by the brightness control.

2. Turn all "screen" controls fully clockwise.

3. With a grid shunt box (Fig. 2), determine which of the three colors produces the *dimpest* horizontal line. Adjust the KINE BIAS control until this dimmest line is just barely *extinguished*.

4. Adjust the other two screen controls, one at a time, until their horizontal line is barely extinguished.

5. Return the NORMAL-SERVICE switch to normal.

6. Tune in a station.

7. Turn the blue and green drive controls fully *counterclockwise*. This should give the picture a brownish tint.

8. Alternately advance the drive controls until you obtain a normal blue-

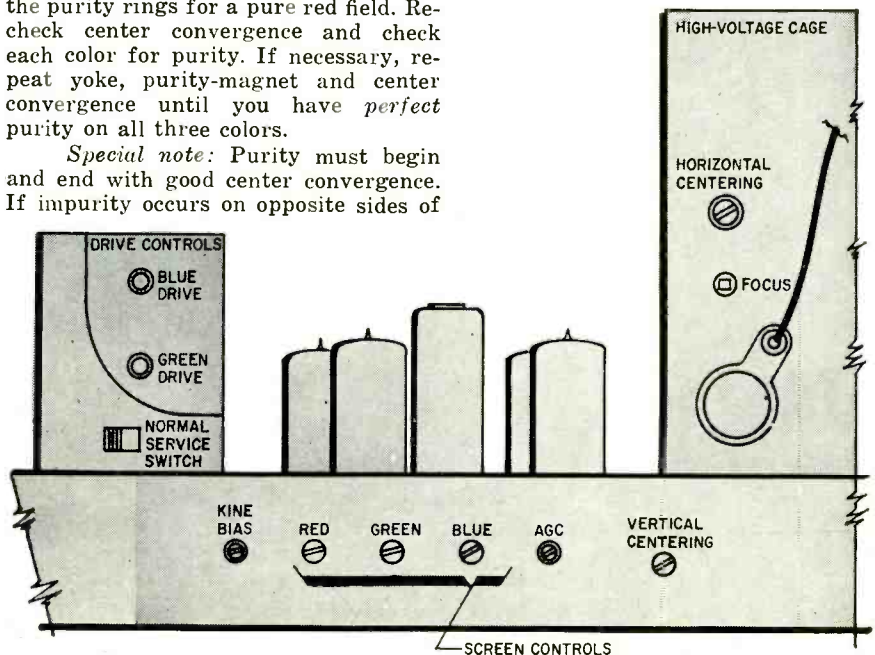

Fig. 1—Rear of color chassis showing position of controls.

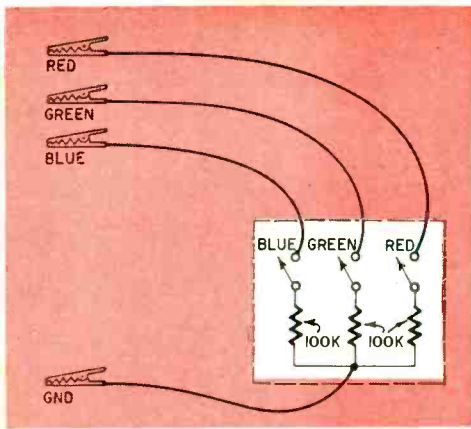

Fig. 2—Grid shunt box disables color picture-tube guns during purity, convergence and gray-scale tracking adjustments.

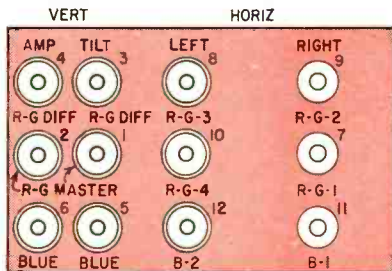

Fig. 3—RCA convergence panel with sequence of adjustment.

white picture. The picture should now track (colors not change) at all normal brightness and contrast control settings.

Convergence

There is no great mystery about making convergence adjustments. You must have a good dot-bar generator or its equivalent, but otherwise you need only common sense and some practice. Fig. 3 shows the sequence of adjustments for RCA. Fig. 4 gives the sequence for Zenith sets. As we said at the beginning, make several fast adjustments rather than one slow and careful one, since the controls interact somewhat.

The crosshatch is used for dynamic convergence adjustments. For vertical adjustments, watch *only* the complete vertical center bar, also a horizontal bar about 2 inches from the top, one about 2 inches from the bottom and one at the center—but *only where they cross the center vertical bar* (Fig. 5)!

For horizontal convergence, watch *only* the middle horizontal bar, also a

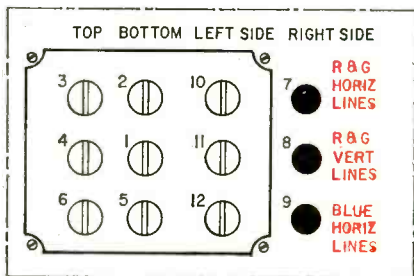

Fig. 4—Zenith convergence panel layout. Note top row of controls for red and green horizontal lines; second row for red and green vertical lines.

vertical reference bar about 2 inches from the left, one about 2 inches from the right hand side and the middle vertical bar—but *only where they cross the middle horizontal bar* (Fig. 6).

The idea in convergence is to get good relationship between all the color lines at these checkpoints. The color bars need not overlap but should be in the same relationship. For example, if one color bar is $\frac{1}{4}$ inch above the other at a specific check point, it should also be $\frac{1}{4}$ inch above it at the other check points. Don't be afraid to jiggle the controls for the best effect even if it may not always be in the specific order—this is especially true in the final touchup procedures.

Final touchup

After you have completed the convergence adjustments, change the generator to dots. Carefully center-con-

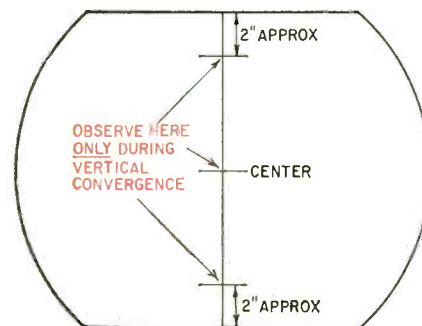

Fig. 5—What to look at in the cross-hatch pattern when adjusting vertical convergence.

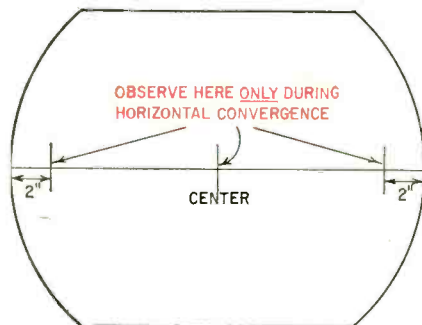

Fig. 6—What to look at in the cross-hatch pattern when adjusting horizontal convergence.

verge again (dc). Recheck all the vertical and horizontal adjustments (dynamic convergence) and then center-converge again!

Color-killer adjustment

Tune in a normal black-and-white picture. Adjust the fine tuning for sound bars then back up until they just disappear. Turn the color control full on. Adjust the color-killer control (inside shaft of vertical hold control) until the colored snow barely disappears. Recheck to see that screen color and tracking is still OK.

We especially want to thank Carl Babcoke, service manager of RCA Distributing Co. of Kansas City, for a great deal of help in the preparation of this story. END

transistor antenna coil

AN EXCELLENT — FERRITE — TRANSISTOR antenna coil can be built by using a half-section core from a discarded flyback transformer and winding approximately 28 turns of No. 20 plastic-coated hookup wire around it as shown in Fig. 1. Any ferrite unit of the two-section variety is suitable. The most difficult job is removing the bad flyback coil, which should pull right off.

Most flybacks come apart from the coil by unfastening the bolts holding the assembly and core. Some cores may have to be tapped gently with a screwdriver handle to separate the sections.

Start the antenna-coil winding by securing the first turn with electrical tape tucked under the next few windings. Tap the third turn for a low-impedance ground return—a good ground at this point makes a surprising difference—then continue winding until the last turn is in place on the core leg (Fig. 1).

It is sometimes necessary to spread the last few turns from the main body of the coil to make it track efficiently on the low-frequency end of the broadcast band when used in a superhet circuit. The coil turns on the core leg provide for this requirement.

Ferrite antenna coils and loopsticks can be critical in operation and final adjustment, so it is recommended that the constructor do a little experimenting with his coil to suit the particular setup involved.

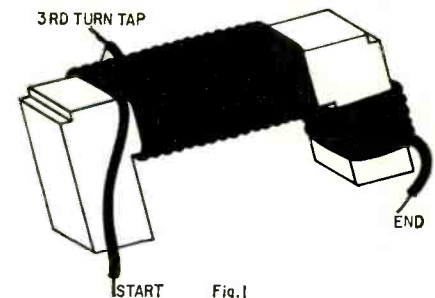

Fig. 1

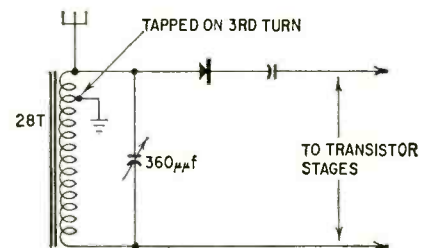

Fig. 2

Using a 1N64 diode as a simple detector (Fig. 2), a transistor af circuit with two 2N107's, a 1.5-volt penlight cell and a mighty sad pair of earphones, I was able to separate and really enjoy reception from four local stations. Volume was more than ample and comparable to anything using vacuum tubes.—George D. Philpott

What's New



CORONA HUNTER uses ultrasonic "gun" to check high-voltage transmission line for electrical leakage. Corona produces high-frequency sonic waves which are received by the Westinghouse instrument and made audible through electronic circuitry. Telescopic gunsights on the unit pinpoint corona sources. Loudspeaker is built into gunstock at ear level.

PRECISION SATELLITE TRACKING from Bell Telephone satellite station in Andover, Me., will depend on accuracy of this 70-foot wheel (right). Machined to greater precision than a wheel for a fine watch, it weighs in at 40 tons, will be used to rotate a large antenna for experiments in satellite communications.

TUBELESS ELECTRON TUBE (left) has no envelope. Developed by ITT for use in spacecraft or satellites where there is no air, the envelope is not necessary. The particular unit shown here is a windowless multiplier phototube. A conventional tube of the same type is on the table.

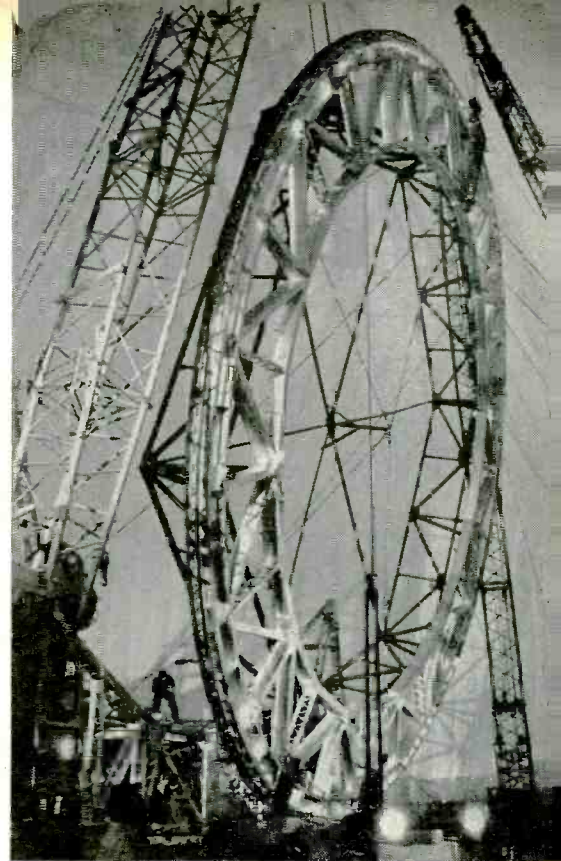

TELESCOPIC TV EYE gets once-over from two Scouts. This unit is a model of the RCA TV camera carried aboard each Ranger space vehicle. Peeping through a specially designed telescope, it will take detailed views of the moon's surface.

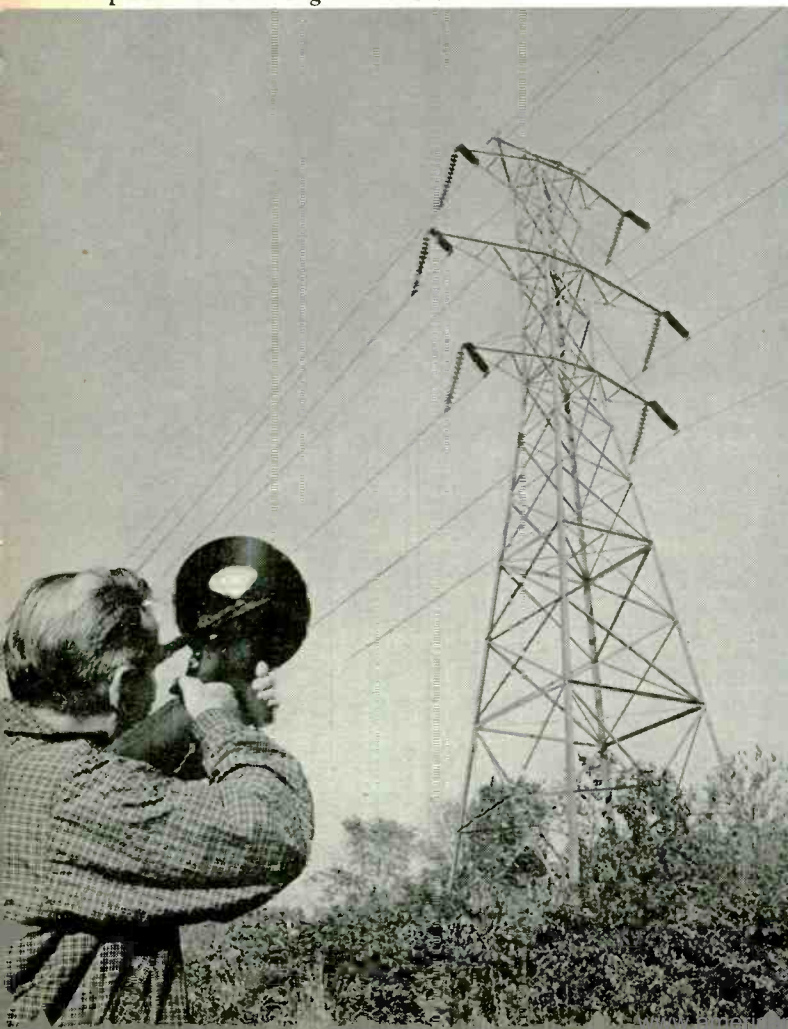

I HAVE A VERY THIN FACIAL SKIN AND a *very* stiff beard. Consequently, practically every day I cut myself with my razor; then I have to use alum and styptic sticks to repair the bloody damage. This can become very annoying over the years.

Well, you might ask, why not use an electric shaver? A good question, but I have tried many and found them wanting, particularly with my heavy, stiff beard. None of them give me the clean, close shave I demand.

I began to think deeply for a long time, and study the entire razor subject from A to Z because I became convinced that there *must* be something better than present-day razors. Well, there is.

A few years ago I read in a RADIO-ELECTRONICS editorial a piece that impressed me greatly. This was the August, 1957, issue and the story was entitled "Electronmechanics" (Page 29).

It pertained to a newly-issued patent by R. H. Steigerwald (Patent 2,793,281; May 21, 1957). The device is chiefly a cathode-ray oscilloscope (CRO) generating powerful cathode rays. Says the editorial:

"It uses the kinetic energy of a concentrated electron beam to drill fine holes of the unprecedented order of 0.1 millimeter. *Yet these microscopic holes can be drilled in the hardest materials, such as steel, stone, glass, tungsten (and its carbides), molybdenum, and even diamonds!*

"Using the same means, unbelievably fine holes with a diameter of only .001 millimeter can be drilled in these same substances in times measured in seconds. Nor are the holes drilled through thin foils. *They have a depth of several millimeters.* Also, the holes can be drilled conically, if desired.

"While the term 'drilling' is constantly used in the description of the invention, it should be noted that the drilling is actually done by heat. Therefore, it must be called a thermomechanical means."

This gave me the fundamental idea for my *Electronic Razor*. I have worked on it intensely for several years, and I have it perfected now. It will be ready for the market shortly.

Now, as all CRT technicians know, cathode rays are generated only in an evacuated tube. Hence all CRT's, particularly those that generate powerful streams of rays, do so only in a high vacuum. Thus the glass wall of a TV cathode-ray tube absorbs practically all cathode rays.

Up to now, cathode rays could not be projected in a satisfactory manner into the atmosphere, that is *outside* of a cathode-ray tube.

I experimented with various thin, metallic "windows", like those of a Lenard tube, from which the cathode rays would emerge, but none proved satisfactory. Such windows were of course very small, usually less than 1/8 inch in diameter, just large enough to let the cathode rays through. But, as I discovered, the electron stream was largely absorbed by the metallic window.

Finally I started to work with semiconductor windows, and that



NEW-electronic razor

No moving parts and no razor burn

By MOHAMMED ULYSSES FIPS, IRE*

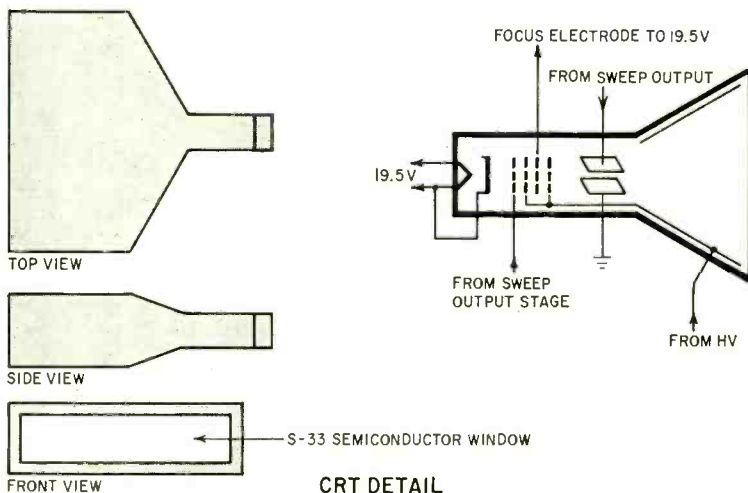

Fig. 1—Three views of the special CRT plus a schematic representation.

*Institute Radiation Engineers.

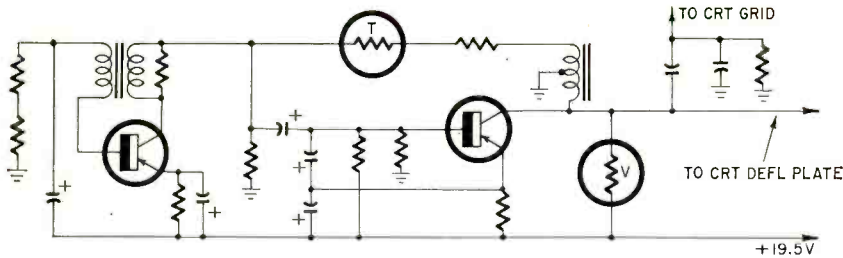

Fig. 2—This simple sweep circuit directs the sheet beam of the CRT across the screen.

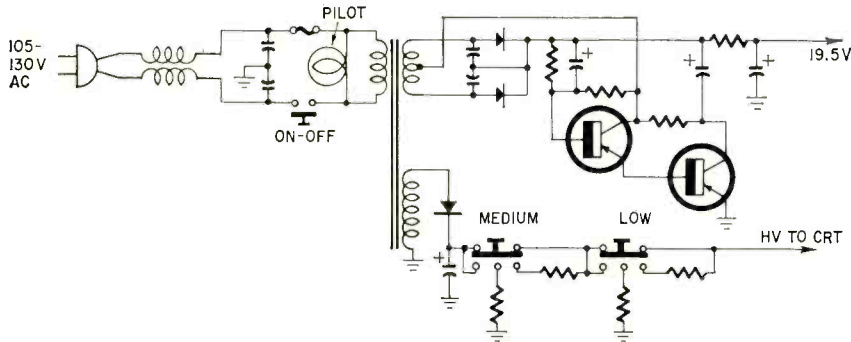

Fig. 3—Power supply for the razor. When on-off switch is closed, razor operates at maximum power to handle tough beards. Depressing the medium button reduces high-voltage applied to the CRT, and reduces intensity of the electron beam for medium beards. Depressing the low button reduces high voltage further for light beards or sensitive skin.

proved to be the solution of the problem. I tried silicon, germanium and others, but the ideal proved to be what is now technically called S-33, a combination of refractory semiconductors. It really is what I call a semi-conductor alloy. It has a very high melting point, is hard and refractory, and makes the ideal window in that it passes a very high percentage of the powerful cathode rays. For obvious patent reasons, the actual specifications and composition of S-33 and its manufacturing processes cannot be divulged here.

If the thickness of the S-33 window is chosen carefully, the cathode ray stream that issues from S-33 will not cause burns on the skin for the following reasons.

The window shape as shown in diagram Fig. 1 is rectangular, about 1/16 inch high by one inch wide. Because the cathode ray rapidly sweeps from side to side over the full 3/8-inch

arc of the window, and because the whole razor sweeps over the face, too, the cathode rays can remain over only any one point on the face for a small fraction of a second. This, however, suffices to burn off the whisker protruding *above the skin*, cleanly and efficiently.

Note particularly that as in all safety razors, there are metal safety shields on both long sides of the CRT. They extend a fraction of an inch ahead of the face of the CRT and prevent the "razor" from coming too close to the skin.

As the burning effect of the electron stream is confined to about 1/8 inch from the surface of the window, the metal shields keep it from harming the underside of the nose, lips or ears. This effect, as already stated is due to the correct thickness of the S-33 window.

In practice, the electronic razor gives the fastest shave of any known razor. You go over the face only once, so rapidly that the average "shave" takes only about 8 to 10 seconds! Then you use the usual after-shave lotion—that is all.

I predict that in time the electron razor will supplant all present-day razors.

For fuller explanation of the technical details of the new razor, see the illustrations in Figs. 2 and 3.

* * *

Because all the research on my new razor had been done in my elaborate laboratory at home, none of my co-workers and editors knew anything about my invention—least of all the Big Boss in the front office, who has the habit of sticking his nose into everyone's affairs.

Thus, a few weeks ago, right after lunch, when the illustrious Big

Man—we actually call him Bignose—was smoking his 7-inch cigar, I went in to see him with my perfected model of the electronic razor.

I explained the principle to him in a few sentences, and as I could see that he hadn't shaved that morning, I invited him to try it out. On his agreeing, I plugged the cord in the outlet behind him, and he proceeded to "shave." He did it in 10 seconds flat on my pocket stop watch. He evidently liked it, since he smiled one of his rare grimaces.

He even offered me a high price for my illustrated article and its sole publishing rights. He was in a rare mellow mood.

Suddenly his face contorted into dark clouds, and lightning flashed from his black, beady eyes.

He slammed his lit cigar ferociously onto his glass-topped desk, which instantly caused a beautiful pattern of fireworks and shredded cigar particles.

Then he yanked the plug from its outlet and smashed the only model of my electronic razor on the hardwood floor, where it created a far from beautiful pattern as all the smashed components flew in every direction.

His face an apoplectic blue-red, he now bellowed: "Fips, you . . . you . . . vacuum-brained nogoodnik . . . what are you trying to do to me? You know that I own thousands of shares of Hemington and Schlick Razor companies! Don't you know that that insane contraption of yours will ruin all razor companies and me, too? Out of my sight, you . . . you electronut!"

With that he took me by the coat collar and propelled me from his office. Here I collided with the cashier, who was on his rounds distributing the weekly paychecks. He handed me my check as I sailed past him.

Still stupefied from my unexpected treatment by the boss, my eyes scanned the top of the check. It read:

APRIL 1



The completed electronic razor.

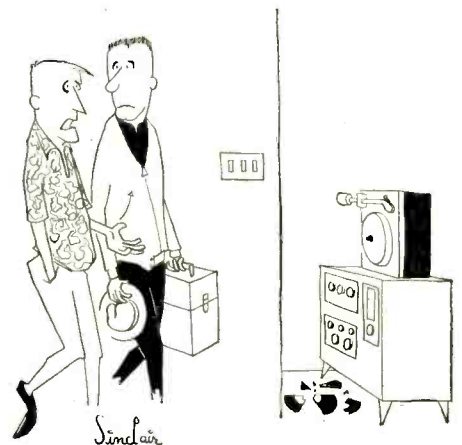

"My new arm tracks fine, but the record keeps falling off the turntable."

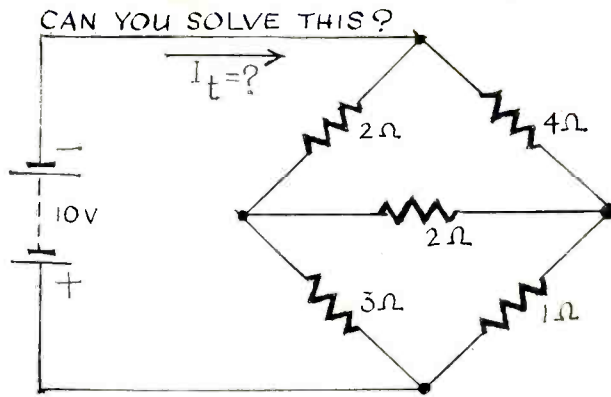

solve your problems with Kirchhoff's Laws

It's simple to figure out networks that look hopelessly complicated

By JOHN COLLINS

CAN YOU SOLVE THE BRIDGE PROBLEM IN Fig. 1? It will probably give you trouble. Why? Because most radio men are thoroughly familiar with Ohm's law but have little more than a nodding acquaintance with Kirchhoff's laws. This is unfortunate. Kirchhoff extended Ohm's theory, and his method makes it easier to analyze complicated circuits like the bridges, filters and impedance-matching networks so common in radio and electronics. So the technician who can apply Kirchhoff's method has a leg up over one whose knowledge stops with Ohm.

Kirchhoff's laws themselves (there are two) are pretty self-evident:

1. The sum of the currents flowing into a junction is equal to the sum of the currents flowing out of it.

2. In any closed circuit, the sum of the voltage drops is equal to the applied voltage.

Fig. 2 illustrates these concepts.

In applying Kirchhoff's laws to network problems, follow these rules:

1. A separate current is assumed for

CAN YOU SOLVE THIS?

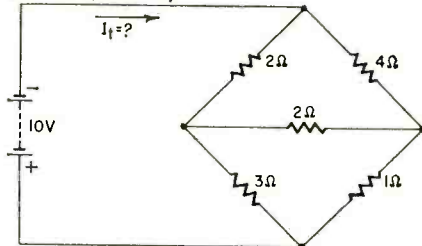

Fig. 1—This typical bridge circuit looks really hard to calculate when unbalanced.

each closed circuit, or "loop," and is called its "loop" current. (Since the bridge circuit in Fig. 1 has three closed circuits, three loop currents are needed for the solution.)

2. In a given loop, the IR drops caused by its loop current are always positive.

3. In a given loop, the IR drops caused by the current from an adjacent loop may be either positive or negative, depending on whether the direction of flow is the same or opposite to the direction of the loop current. (Don't worry if you don't understand this; it will become clear from the examples that follow.)

4. A voltage source is given a positive sign if its polarity is such that it aids the loop current—that is, if the loop current flows from negative to positive in the external circuit. It is negative if it opposes the loop current.

A practical example

The above rules are logical consequences of the two laws of Kirchhoff. To demonstrate how to apply them to practical circuits, we will start with an analysis of the series-parallel circuit shown in Fig. 3-a. Since there are two loops, we begin by assuming two currents, I_a flowing through loop A and

I_b through loop B. There is nothing in the rules about the direction of the assumed currents. We have shown both flowing in a clockwise direction simply as a matter of choice.

Loop A is redrawn in detail in Fig. 3-b, so that we can concentrate on the factors in that loop without being distracted by the rest of the circuit. I_a flows through both the 2-ohm and 6-ohm resistors, producing IR drops of $2I_a$ and $6I_a$. Since I_a is the "loop" current, both these IR drops are positive, according to Rule 2 above. However, I_b , from the adjacent loop, also flows through the 6-ohm resistor. Since its direction is opposite to I_a , it causes a negative IR drop, $-6I_b$, in accordance with Rule 3. The polarity of the battery is such as to aid I_a and hence, by Rule 4, it is given a positive sign.

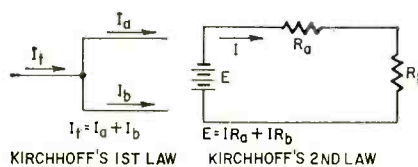

Fig. 2—Kirchhoff's two laws illustrated.

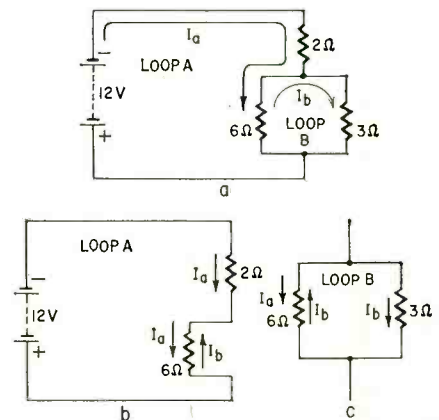

Fig. 3—How Kirchhoff's laws are applied to a simple series-parallel circuit.

Putting all these facts together, we can now write the equation describing loop A:

$$2I_a + 6I_a - 6I_b = 12 \quad (A)$$

When the two terms involving I_a are added, the equation becomes:

$$8I_a - 6I_b = 12 \quad (A)$$

We next examine loop B, as redrawn in Fig. 3-c. You will observe that I_b , the so-called "loop" current for loop B, flows through both the 6-ohm and the 3-ohm resistors, creating two positive IR drops, $6I_b$ and $3I_b$, (Rule 2). Since I_a flows in the opposite direction through the 6-ohm resistor, it produces a negative IR drop, $-6I_a$, (Rule 3). Finally, since there is no battery or generator in the circuit, the IR drops are equal to zero.

Expressing these observations as an equation, we write:

$$-6I_a + 6I_b + 3I_b = 0 \quad (B)$$

We add the two terms involving I_b , and the equation becomes:

$$-6I_a + 9I_b = 0 \quad (B)$$

We now have two equations with two unknown quantities, I_a and I_b . Any number of values can be found for I_a and I_b that will satisfy either equation taken by itself. Equation B, for example, can be solved with any of the following sets of values: $I_a = 3, I_b = 2$; $I_a = 6, I_b = 4$; $I_a = 9, I_b = 6$; $I_a = 12, I_b = 8$; etc. However, only one set of values will satisfy both Equation A and Equation B. Since both must be considered at the same time to find this single solution, they are called "simultaneous" equations.

Simultaneous equations are solved by adding or subtracting them in such a way as to obtain one equation with one unknown. The first step is to modify the equations by multiplying or dividing them so that a term in one becomes identical with a term in the other. As long as each of its terms is multiplied or divided by the same number, the equality of the equation is not changed.

To illustrate, we first divide Equation A by 2, and obtain:

$$4I_a - 3I_b = 6 \quad (A)$$

Next, we divide Equation B by 3, obtaining:

$$-2I_a + 3I_b = 0 \quad (B)$$

Then we add the two equations:

$$4I_a - 3I_b = 6 \quad (A)$$

$$-2I_a + 3I_b = 0 \quad (B)$$

$$\hline 2I_a = 6$$

$$I_a = 3$$

I_b is obtained by substituting the value found for I_a into either of the original equations. If we substitute 3 for I_a in Equation B, we obtain:

$$(-2 \times 3) + 3I_b = 0$$

$$-6 + 3I_b = 0$$

$$3I_b = 6$$

$$I_b = 2$$

To prove the answer, you can sub-

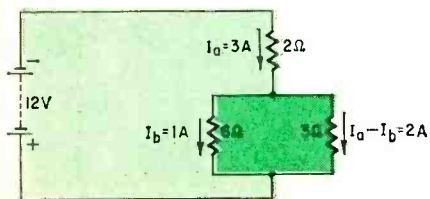

Fig. 4—Solution of the Fig. 3 problem.

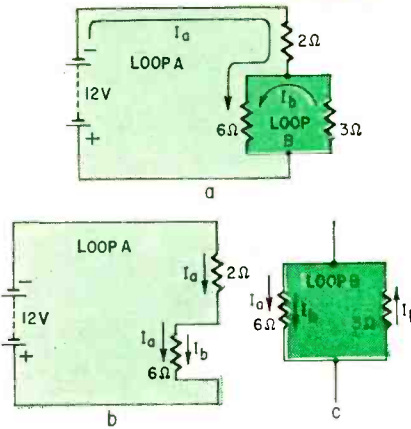

Fig. 5—Kirchhoff's laws work both ways.

stitute 3 for I_a and 2 for I_b in Equation A. Since they are simultaneous, both equations are solved by the same set of values.

The final solution is obtained by going back to the original problem and filling in the values we have found for the currents, adding or subtracting them as necessary where more than one current flows through a branch of the circuit. The result is shown in Fig. 4. I_a , a current of 3 amperes, flows through the 2-ohm resistor; I_b , a current of 2 amperes, flows through the 3-ohm resistor, and 1 ampere, the difference between I_a and I_b , flows through the 6-ohm resistor.

It's hard to go wrong

In the foregoing example, current flow was in the direction we originally assumed. In more complicated circuits it is not always easy to tell beforehand which way the current will flow through a particular branch. Before leaving this example, therefore, let's see what would happen if we had guessed wrong on the direction of current flow and had assumed I_b to flow counterclockwise, as shown in Fig. 5.

With the detailed diagram in Fig. 5-b before us, we write the equation for Loop A:

$$2I_a + 6I_a + 6I_b = 12 \quad (A)$$

You will notice that this is identical with the equation we previously found for loop A, except that the voltage drop caused by I_b now has a positive instead of a negative sign. This is because I_b

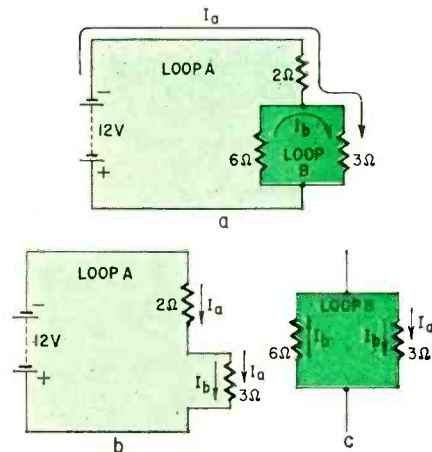

Fig. 6—In fact, they work three ways.

now is assumed to flow in the same direction as I_a through the 6-ohm resistor, and Rule 3 applies. Adding the two terms involving I_a and dividing the entire equation by 2, we obtain:

$$4I_a + 3I_b = 6 \quad (A)$$

Referring to Fig. 5-c, we write the equation for Loop B:

$$6I_a + 6I_b + 3I_b = 0 \quad (B)$$

This equation is the same as in the original example except that the IR drop caused by I_a in the 6-ohm resistor is now positive, since I_a is now assumed to flow in the same direction as I_b .

When the terms involving I_b are added and the entire equation is divided by 3, we obtain:

$$2I_a + 3I_b = 0 \quad (B)$$

We then eliminate I_b by subtracting the two equations:

$$4I_a + 3I_b = 6 \quad (A)$$

$$2I_a + 3I_b = 0 \quad (B)$$

$$\hline 2I_a = 6$$

$$I_a = 3$$

I_b is found next by substituting 3 for I_a in either of the equations. If we substitute in Equation B, we obtain:

$$(2 \times 3) + 3I_b = 0$$

$$6 + 3I_b = 0$$

$$3I_b = -6$$

$$I_b = -2$$

A negative sign in the solution means that we have assumed current flow in the wrong direction, and that it actually flows in the opposite direction. In other words, our assumption that I_b flows counterclockwise is false, and it actually flows in a clockwise direction. If we make this correction, we wind up with the same result as in the original solution, even though we started with a false assumption.

The fact that answers are *always* correct, no matter what preliminary assumptions are made, is one of the more attractive features of the Kirchhoff technique. At the risk of working this example to death, let's try one more set of assumptions, as shown in Fig. 6. We again assume that both I_a and I_b flow in a clockwise direction, but this time we assume that I_a takes the long route, though the 3-ohm resistor.

The details of loop A are shown in Fig. 6-b. Observing the rules previously stated, we write the equation for that loop:

$$2I_a + 3I_a + 3I_b = 12 \quad (A)$$

$$5I_a + 3I_b = 12 \quad (A)$$

Referring to Fig. 6-c, we next write the equation for loop B:

$$3I_a + 6I_b + 3I_b = 0 \quad (B)$$

$$3I_a + 9I_b = 0 \quad (B)$$

Equation B is then reduced by dividing it by 3, and we obtain:

$$I_a + 3I_b = 0 \quad (B)$$

The solution is completed as in the previous examples, by subtracting the two equations to eliminate I_b , and thus

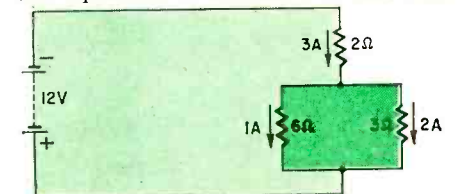

Fig. 7—Fig. 6's way of getting the answer.

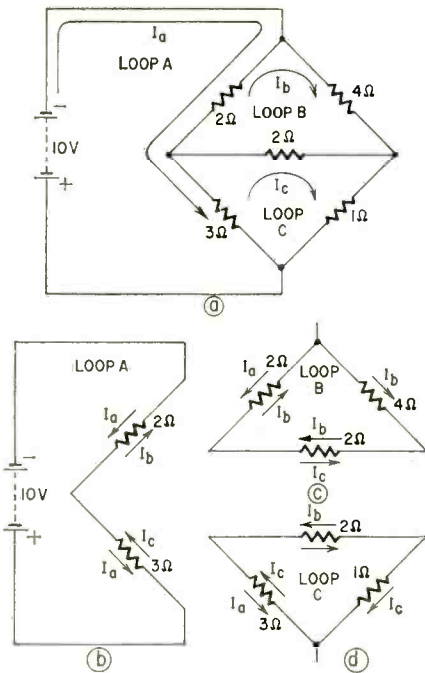

Fig. 8—Back to the bridge circuit.

find the value of I_a . That value is then substituted into either of the first equations to obtain the value of I_b . This procedure yields $I_a = 3$, $I_b = -1$.

The negative value means that I_b actually flows counterclockwise. The result is illustrated in Fig. 7. I_a flows downward through the 2-ohm resistor, and I_b flows downward through the 6-ohm resistor. In the 3-ohm resistor, the current is the difference between I_a and I_b , or a current of 2 amperes in a downward direction. So the final solution is the same as in Fig. 4, even though we started with a different set of assumptions.

The several other possible combinations will all give the same answer—you can't go wrong!

Solving a real problem

The real benefits of the Kirchhoff method show up in problems that are hard to handle with Ohm's law. Now that we are familiar with the ground rules, we can tackle the bridge circuit of Fig. 1. It is redrawn in Fig. 8 to show the three loop currents needed for the solution and to provide detailed drawings of the individual loops. We can write the equations easily:

$$\begin{aligned} 5I_a - 2I_b - 3I_c &= 10 & (A) \\ -2I_a + 8I_b - 2I_c &= 0 & (B) \\ -3I_a - 2I_b + 6I_c &= 0 & (C) \end{aligned}$$

No matter how complicated a circuit may be, it is easy to write the equations describing it. Solving the equations can

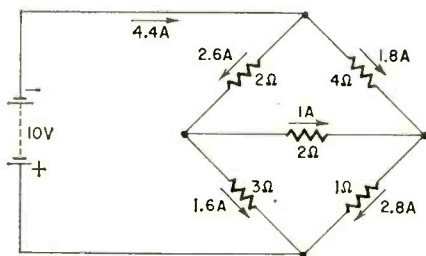

Fig. 9—Kirchhoff's laws make this as easy to solve as the simpler circuits.

be harder. When there are only three equations, it is not hard to combine, say, the first and third to eliminate one unknown, and then the second and third to eliminate the same unknown. This will leave two equations with two unknowns, which can then be solved as in the previous examples.

Multiplying the first equation by 2 and adding it to the third equation:

$$\begin{aligned} 10I_a - 4I_b - 6I_c &= 20 & (A) \\ -3I_a - 2I_b + 6I_c &= 0 & (C) \\ \hline 7I_a - 6I_b &= 20 & (AC) \end{aligned}$$

The second equation is then multiplied by 3 and added to the third:

$$\begin{aligned} -6I_a + 24I_b - 6I_c &= 0 & (B) \\ -3I_a - 2I_b + 6I_c &= 0 & (C) \\ \hline -9I_a + 22I_b &= 0 & (BC) \end{aligned}$$

We now multiply Equation AC by 11 and Equation BC by 3 and add them:

$$\begin{aligned} 77I_a - 66I_b &= 220 & (AC) \\ -27I_a + 66I_b &= 0 & (BC) \\ \hline 50I_a &= 220 \\ I_a &= 4.4 \end{aligned}$$

By substituting 4.4 for I_a in either equation AC or BC, we find that $I_b = 1.8$. Similarly, by substituting the values found for I_a and I_b in any of the original equations, we find that $I_c = 2.8$.

We get the final solution by going back to the circuit diagram and filling in the values for the currents, adding or subtracting them as necessary. The result is shown in Fig. 9.

If you want to experiment, you can assume different directions or paths for the currents. In any case, you should get the same result.

The above examples involve only resistance. Kirchhoff's method works just as well with impedances in ac circuits. In such problems, the instantaneous current at some part of the cycle can be used to establish direction. Once you have mastered the mechanics, you will find Kirchhoff's laws useful in analyzing a variety of circuits that don't respond to other methods. END

Variable Time-Constant Avc

THE usual AM-broadcast or all-wave receiver has an avc circuit similar to that shown in Fig. 1-a. The rate at which the varying avc voltage decays is determined primarily by the product of $R1$ and $C1$, and to a lesser extent by $R2$ and $C2$. The product of $R1$ (in megohms) and $C1$ (in μf) gives the avc time constant system discharge in seconds. For example, if $R1 = 0.5$ megohms and $C1 = .05 \mu f$, $TC = .025$ sec.

Ordinarily, the set designer selects a combination of $R1$ and $C1$ which is a compromise of several factors. If the time constant is too fast, the avc voltage will vary with the audio modulation of a signal, rather than with carrier strength, causing distorted reception. If the time constant is too long, tuning is difficult. When tuning across a strong station, a large avc voltage is developed, but because of the long time-constant it takes an appreciable time to decay. As a result, the receiver may be insensitive for an appreciable time after tuning past the strong station. Another

disadvantage of too long a time constant is the inability of the avc voltage to follow rapidly fading signals.

Ideally, the time constant should be adjustable so that the operator can select the one best suited to the signal being received. A variable time constant can be added to existing avc systems by making either $R1$ or $C1$ variable. Fig. 1-b shows a circuit where $R1$ is varied, giving continuous variation of the time constant over a wide range. Fig. 1-c varies $C1$, using a three-position switch. Of course this does not provide continuous variation but is desirable where $R1$ cannot be increased in value because of possible damage to controlled tubes of high mutual conductances. In no case should $R1$ be made less than about 470,000 ohms.

As a general rule of thumb, the longer time constants are preferable when listening to music programs, particularly on good-fidelity receivers. The shorter time constants are more useful where fading is common. END

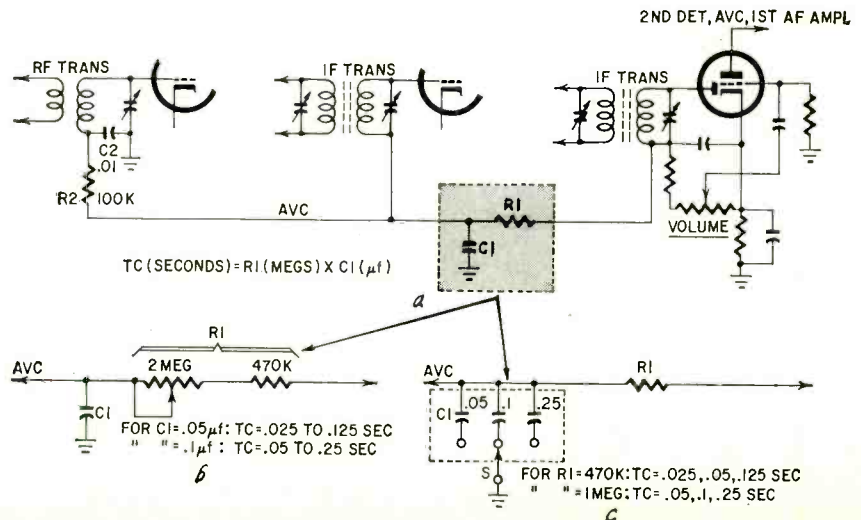

SERVICE CLINIC

Conducted by
JACK DARR
SERVICE EDITOR

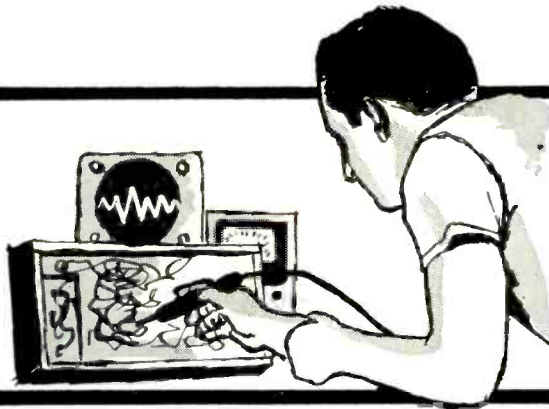

This column is for your service questions. We answer them free of charge and your name and address will be kept confidential if you wish. The main purpose is to help those working in electronics with their problems.

We've changed our target a little and are no longer restricted to TV. Radio, audio and industrial electronics problems are also grist for the mill. All letters get a prompt individual answer and the more interesting ones will be printed here. So if you have a service problem, send it here. We'll do our very best to help you solve it.

THE DESIGN OF A TV SET CAN RESULT IN troubles for the TV technician. This turns up mostly in the smaller and cheaper sets, but also crops up every now and then in the better makes. If the set designer has a tendency to overdrive his tubes, for economy, especially in the sweep circuits, their life is shortened greatly, and the resulting troubles are often blamed on the technician.

This can be avoided by checking the operating constants carefully every time one of these sets is serviced. Check plate currents on horizontal output tubes. If they are not within limits, see that they are before you return the set. For instance, if a 6BQ6 tube is used in the horizontal output stage, with a plate current of more than 100 ma, its life will be very short. If the width and high voltage are not right after this current has been reduced to proper values, replace the 6BQ6 with a 6DQ6. This tube is electrically equivalent to the 6BQ6 but will withstand as much as 140-ma plate current. It is also very useful for getting that last inch of width on some sets.

The 6W4 damper used in many older sets usually breaks down between the heater and cathode. These sets often have a highly insulated separate winding on the power transformer for the 6W4 heater. Heater and cathode are tied together at the socket. Unless the transformer has developed shorted turns in the damper heater winding, replacing the tube with a 6AX4 and cutting the tie between heater and cathode will cure the trouble. If the heater-cathode peak voltage is very high, use a 6AU4 to replace the damper. The only difficulty with this is the 6AU4 heater current. It needs 1.8 amperes as compared to the 1.2 amperes of the 6W4 and 6AX4. In a transformer-supply set, the power transformer will usually handle the added 600 ma without overheating. In series-filament sets, only tubes with the same current drain can be used.

The 6SN7 is used in quite a few sets as both vertical oscillator and out-

put. If it gives trouble, try replacing it with a 6BL7. This tube is electrically identical, but has a higher output. If the tube is a 6BL7 to begin with, use a 6BX7. It is also identical to the 6SN7, but has more output than the 6BL7. If the set used a type 6BX7 originally, and still has short tube life and insufficient height you may be up the proverbial river. This actually happened to one well known manufacturer. The only cure was to write the manufacturer. He provided special 6BX7 tubes culled from regular production tests as being especially hot. They were marked with a big X of yellow paint.

In some special cases (we don't recommend this as everyday procedure) if the set's value warrants it, circuits may be worked over to use a different tube type entirely. For example, it might be possible to replace the vertical output transformer and use a 6CM7 or 6CS7 to replace a 6BL7. This is emergency procedure and should be used only if proper replacement parts are not available. We wouldn't recommend trying to redesign every TV set that comes along.

Low contrast

The contrast control on a Philco E3034 doesn't have enough range. I can't get enough dark and light in the pictures, only a slight change. I've checked all voltages, resistances and the age. Brightness good, sounds good.—R.A., Olean, N.Y.

In some circuits, contrast control doesn't have the range of the standard video-output cathode type, which should run from a very pale picture to an almost completely burned-out one. This set has a sort of combination. It works with the age and the video amplifier bias. It doesn't have the range of some other circuits.

Check video if alignment and the trap circuits in the video amplifier. The video amplifier should have a gain of over 25—4 volts peak to peak on the grid and 115 volts peak to peak on the

plate. Loss of gain here affects contrast. Aside from the 6AW8 tube, another possibility would be leakage in the printed-circuit board between the contrast control and the sync separator grid.

Intermittent high voltage

I've a Philco 52T-2259 in the shop with intermittent high voltage. If I pull the cap off the second anode and put it back, the high voltage comes on. Sometimes it will go for days before the picture goes. Everything in the high-voltage system checks out good when it is working. Could it be the picture tube?—C. Z., Hillside, N. J.

Yes, it could, but it is a remote possibility. I'd check a few other things first.

This Philco uses a voltage-doubler system in the high-voltage supply. The plate of the 1X2 doubler is returned to the heater of the 1B3-GT through a pair of special high-voltage resistors, 2.5 megohms each. Either or both of these could be the cause of the trouble.

The most likely suspect would be a corroded connection on the coupling capacitor (from the plate cap of the 1B3-GT to the plate cap of the 1X2) as this was quite common in this chassis. If it is mounted in spring cups, clean these well with sandpaper and tighten. Check the resistors by replacement. Be sure to get the correct resistors; these are special high-voltage types! Standard 2.5-megohm resistors will not hold up in this circuit as many technicians have found out to their sorrow. Philco distributors should have them in stock.

The originals had a bad habit of burning in two right across the middle. They were molded carbon resistors, and the hairline break was often very hard to spot. Check the sockets on the two rectifier tubes for signs of green corrosion on the heater connections.

I believe I would check the picture tube carefully on a good picture-tube tester before doing anything drastic in that department.

Clipped capacitor

In a Tele-Tone TV-357 chassis, the .0022µf capacitor between the plate of the 6W4 damper and the accelerator grid of the picture tube has been clipped out. What is its purpose? The set seems

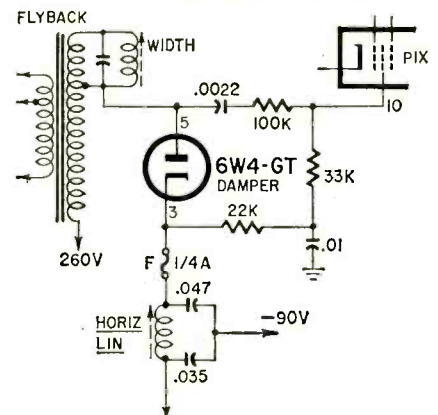

Fig. 1—Clipped capacitor is the .0022µf unit. It was part of the horizontal blanking network and should be reconnected.

to work all right without it.—M. R., New Hyde Park, N. Y.

This .0022 capacitor in Fig. 1 was part of the horizontal blanking circuit. It and the 100,000-ohm resistor in series fed a pulse (spike) to pin 10 of the CRT. This helped eliminate horizontal retrace lines, shadowing from the left, etc. As long as your horizontal oscillator stays right on the nose, you might not notice any difference in the set's performance. If you do replace it, be sure to use a high-voltage unit as it must withstand the high pulse voltage that will be applied to it.

What value

What is the value of the screen dropping resistor on the horizontal output tube of a Tele-King 812? It looks like a 10-watt resistor, but it's made of plastic without any identifying marks! I can't find a schematic for this set.—J. M., Glendale, N. Y.

I couldn't find a listing in any data services for this chassis. However, my transformer catalogues and similar sheets show the flyback and other parts the same as a "712," which is listed in Rider TV-4 and Sams 88-12. These ought to be close enough to give you the data you need.

Size of the screen resistor varies with the B-plus voltage applied to it. Fig. 2 is a chart that shows the proper screen voltages and gives you the correct amount of screen dissipation. If dissipation is too high, the result is excessive current drain through the horizontal output tube, overheating the flyback and causing short tube or flyback life. Always check the screen voltage when a horizontal output tube or flyback is replaced. This also applies whenever changes are made in the horizontal output circuit which could affect the current drain through the tube.

You can measure current directly by breaking the circuit and inserting a milliammeter. If you don't have a milliammeter handy, read the voltage drop across the resistor, measure the resistance and calculate the current. The proper screen current for the 6BQ6 should be about 12.5 ma. Now use the chart in Fig. 2. If the operating point comes out above the line you're dissipating too much wattage. Lower the operating point by either increasing the value of the dropping resistor or tapping it on to a lower-voltage source in the B-plus supply.

This procedure will lower total wattage dissipated by the tube, cool the flyback, and usually result in better operation all around. Sometimes it will even increase width and high voltage.

16- to 21-inch conversion

Can I convert a Philco 50-T1630 chassis from its present 16AP4 picture tube to a 70° 21-inch tube. Since it has a voltage-doubler high-voltage circuit, I ought to have enough high voltage.—W. B., Montclair, N. J.

You can make this conversion OK. I'd recommend a tube such as the 21EP4, which is easy to sweep, and

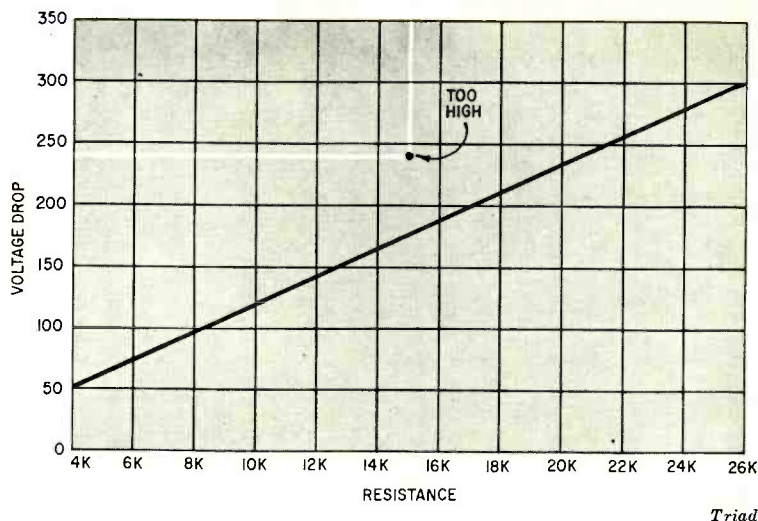

Fig. 2—Screen dropping resistance chart for 6BQ6 horizontal output tubes. To use the chart, measure the resistance of the screen dropping resistor. Be sure you get an accurate measurement and that a shunt path isn't throwing you off. Then measure the voltage drop across the screen resistor. Now draw a vertical line, on the chart, from the resistance value you measured straight down. Also draw a horizontal line from the voltage scale on the left side of the chart. Use the voltage drop you measured.

If the lines intersect above the diagonal line, the screen is dissipating too much power. If they meet on or below the line, everything is OK.

calls for only 12 kv, which is the same as your present 16AP4. Aside from mechanical troubles in mounting the tube, your present sweep circuits should work, provided they are all cleaned and put in first-class shape.

Hula-skirt wiggle

Can you help me with this problem? The complaint is an undulating waviness of the picture, like a Hula girl's grass skirt! Also, I've got a horizontal drift. The frequency of the undulations is not constant, but varies at about 5 seconds per cycle. The drift can be corrected by resetting the horizontal hold about once every 15 to 30 minutes. I'm told this condition has existed ever since the set was purchased in 1952.—F. M. S., Philadelphia.

This is an interesting complaint, if nothing else! However, it should be curable. Check the two 470,000-ohm resistors across the 6AL5 horizontal phase discriminator, preferably by replacing them. Be sure that the replacements are exactly equal in value. Check the 6AL5 for equal emission of both diodes and replace it if the inequality is more than about 5%.

Realign the horizontal phase discriminator transformer, according to standard procedure. If you don't have that handy, here it is:

Tune in a picture and adjust the bottom slug on the transformer until the blanking bar moves to the right. If your ripple or wiggle shows up at this time, turn the slug clockwise until it straightens up. About 1/2 inch of screw protruding from the bushing is considered a normal adjustment.

Now, turn the horizontal hold control counterclockwise and adjust the top slug until the picture falls back into sync. Check by turning the hold control clockwise, then snapping the tuner off-station and back again. The

picture should come in and straighten up all by itself. Turn the control counterclockwise and repeat. You may not have quite a full turn of adjustment on the control, but if the picture will come in by itself with the control in the central 250–275° of its rotation it is working fine.

While you're at it, check electrolytic capacitors connected to the horizontal oscillator circuit. Watch out for high power factor and low capacitance. If this condition has existed ever since the set was bought, you may find a filter capacitor someplace in the circuit whose value will have to be increased. Using a scope, check the B-plus supply circuits around the oscillator and phase comparator for any signs of horizontal (or vertical) frequency ripple. If excess ripple is found, add more capacitance until it is eliminated.

Vertical jitters

I have a Crosley 426 chassis, a 17-inch portable, with vertical jitter. Fellow technicians say that this is a design weakness. Do you know of any modifications that can be made to increase the stability?—R. D., Cincinnati, Ohio

From the frequency of similar complaints on this chassis, your friends may be right. The most likely suspect is the little PC network between the 6U8 sync amplifier and the vertical oscillator grid (Fig. 3). The Crosley part number is 157812-1, but it seems to

(Continued on page 64)

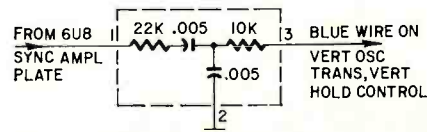

Fig. 3—This PC unit in the Crosley 426 may need replacement if the complaint is vertical jitter.

Put your money in quality parts . . . get

HEATH

THE MOST ADVANCED STEREO TUNER KIT AVAILABLE



Here's the kit tuner you've asked for, the Heathkit AJ-41! AM, FM or Stereo FM Multiplex. Self-contained with Multiplex Adaptor built-in! New FM squelch circuit hushes between-station noise. Stereo Indicator light shows when FM station is broadcasting stereo. Separate tuning meters for AM & FM. Broad-band circuitry. Cathode follower outputs. Preassembled tuner, prealigned coils, circuit boards.

Kit AJ-41, no money down, \$11 mo. . . \$119.95
Assembled AJW-41, \$18 mo. . . \$189.95

Heathkit — always first with the finest, guarantees success with any of these new kits



**New 9-transistor
CITIZEN'S BAND
WALKIE - TALKIE**

Superheterodyne receiver—crystal-controlled transmitter; built-in squelch and noise-limiter; portable-battery powered; 1-3 mile operating range; easy circuit board assembly. 2 lbs.
Kit GW-21 . . . \$44.94 each, \$84.95 a pair



The World at your Fingertips—only \$24.95
 —Covers 140 kc to 18 mc in 4 bands to receive aircraft, broadcast, amateur, police, and foreign stations. Regen. circuit; transformer isolated.
Kit GR-81, no money down, \$5 mo. \$24.95



Step saving WIRELESS INTERCOM—No more connecting wires between stations, just plug in nearest outlet; works with units on same power line. All transistor circuit; built-in AC power supply. "All-master" system, any station may originate a call. Standby squelch circuit. Overload diode. Indicator lights. Beige color.
Kit GD-51-2 (pair) no money down, \$5 mo. . . \$45.90

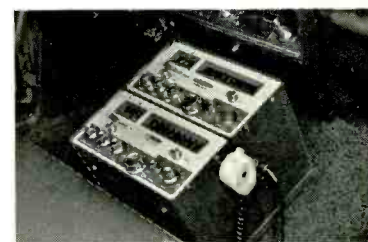

Powerful SSB mobile AMATEUR TRANSMITTER and RECEIVER—Complete SSB facilities! 90 watts, 80 through 10. Loaded with extras for top performance —easy assembly—convenient operation!
Kit HX-20 . . . \$199.95; HR-20 . . . \$134.50
GH-12 Mike Illustrated . . . \$6.95



New miniature HI-FI SPEAKER SYSTEM —AS-81 Series—65-14,500 cps response from 6" woofer and 3" tweeter in factory assembled cabinet just 10 3/4" W x 6 1/2" H x 6 3/8" D. Available wal., mahog. or unfin.
 from **\$17.50**



ELECTRONIC TACHOMETER for in-boards, outboards or cars—Transistor circuit; dual range, 0-4000 & 0-8000 rpm, switch-selected; usable with coil-distributor or magneto systems; price to be announced.

better performance, more satisfaction with

KIT[®]



**TWO NEW HEATHKIT
TUBE TESTERS AND MODERN
TUBE DATA SUBSCRIPTION SERVICE**



TUBE CHECKER IT-21: Successor to famous Heathkit TC-3. Tests all tube types including new compactron, nuvistor, novar and 10-pin types! Built-in roll chart. Individual tube element switches. Tests for quality, shorts, leakage, open elements and continuity. \$44.95

MUTUAL CONDUCTANCE TUBE TESTER TT-1A: Deluxe tube testing facilities! Includes adapter in lid for testing new compactron, nuvistor, novar and 10-pin tube types. Indicates Gm to 24,000 microhoms. Constant current heater supplies. Ultra-sensitive grid current test. Direct reading ohmmeter leakage test. Built-in calibration circuit & roll chart. Professional quality throughout.

\$149.95

ADAPTER KIT TTA-1-1: Converts earlier model TT-1 to TT-1A. Consists of new cabinet lid, sockets and selector switches and necessary tube test data.

\$14.95



NEW TUBE SUBSCRIPTION DATA SERVICE: Up-to-date supplements on all new tube types will be automatically mailed quarterly to all subscribers. New roll chart mailed annually. A valuable service to past and present Heathkit tube checker owners! State your tube checker model upon ordering.

TC-3 series \$1.50 per year, TT-1 series \$2.50 per year.



**WORLD'S BIGGEST
KIT CATALOG—FREE**

Use the coupon opposite to send for your free copy of the new 1962 Heathkit catalog. It's the world's biggest catalog devoted to electronic kits. 100 pages, over 250 different kits, with complete descriptions, schematics, big photographs, and full specifications. Send for yours now!



HEATH COMPANY
Benton Harbor 20, Michigan

Yes, send me my free 1962 Heathkit catalog

NAME _____

ADDRESS _____

CITY _____ ZONE _____ STATE _____

Order direct by mail or see your Heathkit dealer.

Ship Parcel Post Express C.O.D. Best Way

Ordering Instructions: Fill out the order blank. Include charges for parcel post according to weights shown. Express orders shipped delivery charges collect. All prices F. O. B. Benton Harbor, Mich. A 20% deposit is required on all C.O.D. orders. Prices subject to change without notice. Dealer and export prices slightly higher.

ITEM	MODEL NO.	PRICE

(Continued from page 61)

be wiser to replace it with a Sprague 5HK-U5 or by individual parts if you want to.

Check all the plate and grid resistors, plate load resistors and supply voltages on the 6U8. Make sure you have plenty of vertical sync pulses on the grid waveform of the vertical oscillator.

Picture bending

I've noticed a peculiar trouble in a number of TV sets using multivibrator horizontal oscillators. The picture bends much as if 60-cycle ac was getting into the sync, although a scope shows the sync to be clean. Shorting out the ringing coil straightens the picture. Replacing all parts in the horizontal circuit does not help. Damping the ringing coil with a 10,000-ohm resistor seems to help, but I'd like to know what causes it!—W. D. O., St. Louis

The bending you mention is almost always due to lack of filtering somewhere in the circuit. It can be due even to a capacitance loss in the main power-supply filters, but is more often found in the low-capacitance electrolytics close to the point where the B-plus supply for the horizontal oscillator is taken off.

The electrolytic connected from B-boost back to B-plus is a frequent offender. So are agc filters which allow vertical blanking pulses from the video signal to leak into the horizontal circuits. The easiest way to find out is to check out the B-plus supply line(s) to the horizontal oscillator with a scope. Look for excessive ripple. This will cause your trouble.

You can get a similar bend from an oscillator circuit that is improperly set up—operating right on the edge of falling out of sync. Run the standard setup procedure. Short out the ringing coil and adjust the hold control for a stationary picture. Then remove the short and adjust the ringing coil slug for lock-in without moving any other controls. If the oscillator won't hold or straighten up after this, there is a defective part somewhere—a slightly-leaky capacitor, an off-value resistor or a bad part in one of the time-constant (R-C) circuits somewhere in the oscillator stage. These are usually in the grid circuits. END



Substitution Box for power resistors

10 to 25,000 ohms with four resistance units

By HOMER L. DAVIDSON

This little resistance substitution box uses only four resistance units, yet covers 10 to 25,000 ohms in 22 steps. Furthermore, all values are rated at 10 watts minimum. How do we do it? By using four multi-element units each containing four 10-watt resistances sealed in a special steatite housing. Interconnecting the elements with two 11-position rotary switches makes available most of the 10-watt values needed in radio and TV servicing.

All the resistance units used are made by the International Resistance Corp. The MR2 multirange power resistor contains 10-, 20-, 40- and 80-ohm elements. Many basic connections are possible, but those shown appear most practical and useful.

The MR3 has a 10-watt power range between 50 and 1,500 ohms. Again there are four 10-watt resistors in one steatite body with 100-, 400-, 800- and 1,500-ohm elements. The two multirange power resistors (MR2 and MR3) are switched into use by S1, giving a useful range of 10 to 800 ohms. Also parts of both are used in the next higher resistance range, switching in various resistances to add to those in the MR4 and MR5.

The multirange MR4 power resistor covers 10-watt resistance values

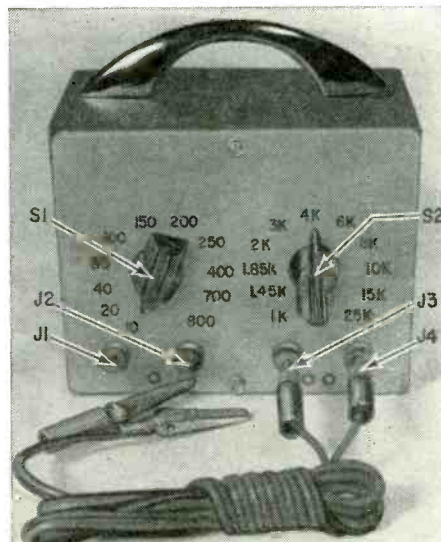

The completed unit. The carrying handle is an optional convenience.

between 500 and 1,500 ohms. The MR5 has two 10,000- and two 15,000-ohm resistors. These two units are switched into higher resistance range with S2. The resistance at the output terminals will be between 1,000 and 25,000 ohms.

Looking at the schematic, we see that we get 1,450 ohms by switching into the circuit 1,000 ohms of MR4, 10, 20, 40, and 80 ohms of MR2 and 100 and 200 ohms of MR3. Similarly, to total 1,850 ohms, an additional 400 ohms of MR3 is switched into the circuit. The resistors are switched by a 2-gang 11-position rotary wafer switch. Two of these switches are needed to cover the range of 10 to 25,000 ohms.

Construction details

Only a drill and various hand tools are needed to build this instrument. First drill all necessary holes. Then spray on about three coats of white or gray enamel paint.

I soldered and mounted the MR2 and MR3 power resistors on switch S1 before mounting on the front panel. Then I checked out the switching of the various resistors with an ohmmeter to make sure that there

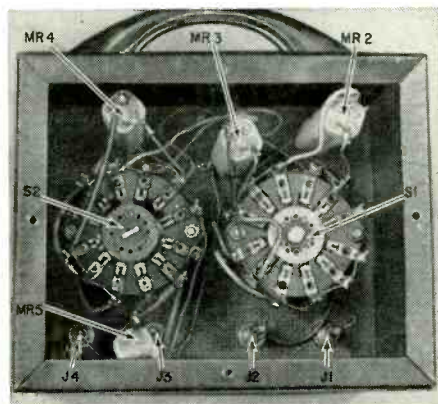

Inside the case, parts arrangement is no problem since there are only two switches, four jacks and four resistance units.

NEW!
products from

SONY[®]

RESEARCH MAKES THE DIFFERENCE

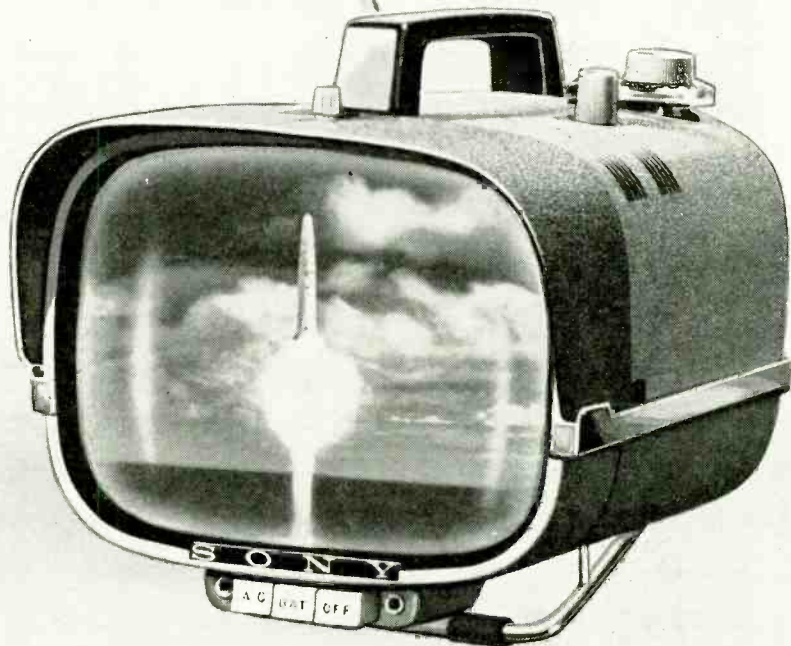
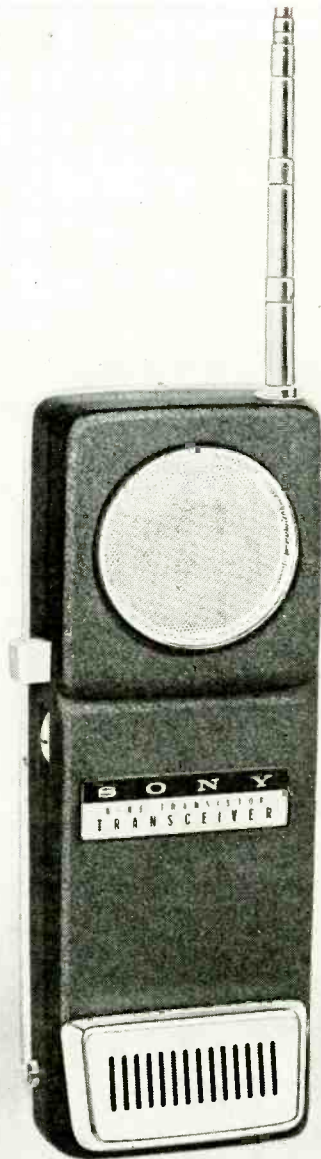

set a trend in transistor electronics

Two remarkable examples of SONY transistor technique are illustrated above. Each is unique (among other reasons) for the fact that it was designed, engineered and manufactured by SONY, recognized as a world leader in quality transistorized electronics. Some other reasons: The SONY 8-301W TV is fully transistorized. Has 23 transistors, 20 diodes, and operates from 3 power sources—its own rechargeable alkaline battery power pack (see illustration); standard AC or 12v auto/boat battery. Weighs only 13¼ lbs., which means it's truly portable. Direct-view 8½" aluminized screen, too. SONY 8-301W list \$249.95. BCP-2 power pack, \$39.95.

The SONY CB-901 transceiver employs a separate microphone and speaker, rather than the single combination mike-speaker system usually used in ordinary units. Built in accordance with Class D Citizens Band specifications, it lists at \$149.95 per pair, includes batteries, earphone and carrying case.



SONY CORP. OF AMERICA

514 Broadway, New York 12, N. Y.
Regional Offices
Western: 627 South Towne Ave., Los Angeles 21, Calif.
Central: 4959 W. Belmont Ave., Chicago 41, Ill.

Please send me the Sony "FACTS" booklet covering the SONY 8-301W TV and information on the SONY CB-901 Transceiver.

NAME _____
ADDRESS _____
CITY _____ ZONE _____ STATE _____

SONY CORP. OF AMERICA, 514 B'WAY, N.Y. 12, N.Y.

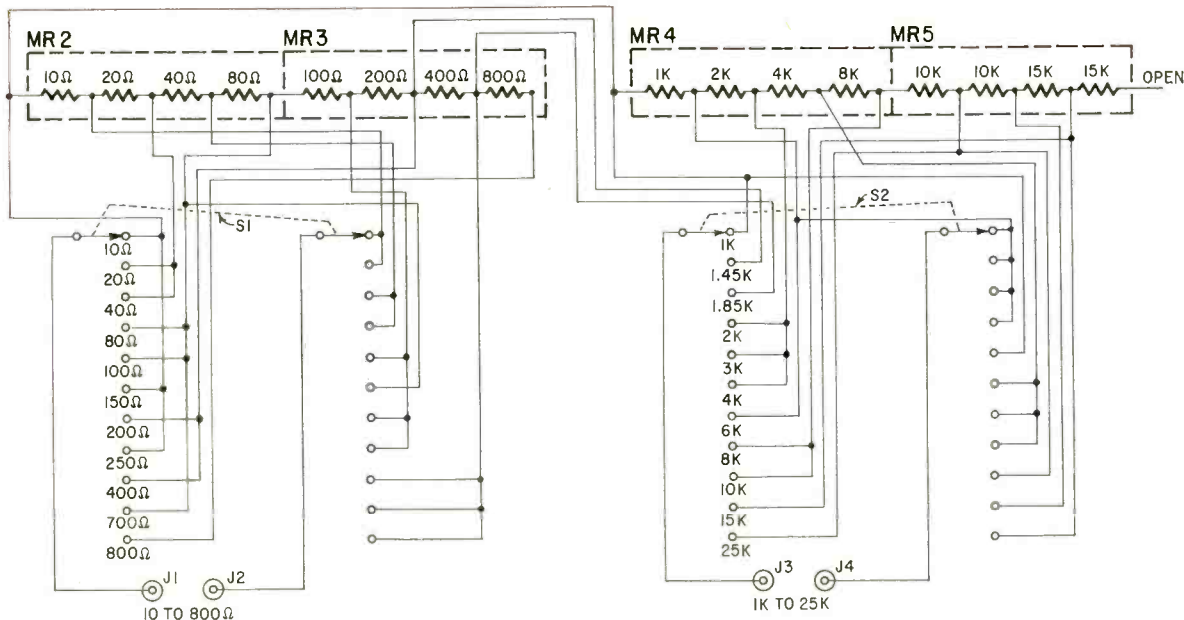

Complete circuit of the simple unit.

MR2—IRC multirange resistor, 10 watts, (10, 20, 40, 80 ohms)
 MR3—IRC multirange resistor, 10 watts, (100, 200, 400, 800 ohms)
 MR4—IRC multirange resistor, 10 watts, 1K, 2K, 4K, 8K)

MR5—IRC multirange resistor, 10 watts, (10K, 10K, 15K, 15K)
 S1, S2—2-pole 11-position rotary switch
 J1, J2, J3, J4—pin jacks.
 Case, to suit
 Miscellaneous hardware

were no wiring mistakes. Next, I proceeded to MR4 and MR5 and mounted them to S2. The resistance was again checked for mistakes and then mounted to the panel board. Tying in leads to form the 1,450- and 1,850-ohm resistances was done next from S2 and S1. Wiring the resistors on the switches before mounting the switches left little

wiring to do once the switches were mounted to the front panel.

Switch positions are marked on the front panel and two separate pairs of jacks are available—one for each switch. Bolt a small kitchen type handle to the top of the cabinet for easy carrying. The back panel can be made from Masonite. The test probe consists of

two simple alligator clips, brown ac line cord and two male phone tips.

Not only will this resistance box substitute for ordinary resistors, but different arrangements will give you other values. The wiring is simple and the cost is nominal compared to using a separate 10-watt resistor in each leg of the multi-range power resistors. END

WHAT'S YOUR EQ?

It's stumper time again. Here are three little beauties that will give you a run for the money. They may look simple, but double-check your answers before you say you've solved them. For those that get stuck, or think that it just can't be done, see the answers next month. If you've got an interesting or unusual answer send it to us. We are getting so many letters we can't answer individual ones, but we'll print the more interesting solutions (the ones the original authors never thought of). Also, we're in the market for puzzlers and will pay \$10 and up for each one accepted. Write to EQ Editor, Radio-Electronics, 154 West 14th St., New York, N. Y.

For answers to last month's puzzle see page 80.

Why The Decrease?

Knobs 1 and 2 are continuously variable from A to B. Set knob 2 at A

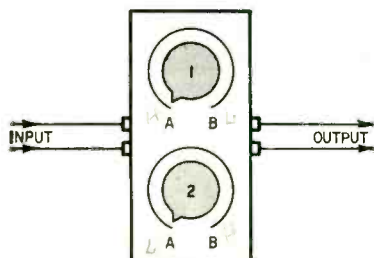

as shown, and rotate knob 1 from A to B. The output will increase.

Now set knob 2 at B and rotate

knob 1 from A to B. The output decreases!

Why?—Henry P. Houton

Too-automatic tuner

Symptoms: Automatic tuner changes stations, turns volume up or down, turns set off, etc., all by itself! Horizontal hold off quite a bit. Very fine lines on screen. Customer has turned horizontal hold control quite a bit out of range. Set is a Zenith 16C21Q.

Clues: As soon as set warms up, automatic tuner takes off and may do anything at all. Cutting it off with selector switch on back allows set to work normally, outside of horizontal hold being away off frequency.

Hint: When picture was locked in by restoring horizontal hold control to

normal, automatic tuner worked perfectly. Is auto-tuner intermittent or what?

Black Box No. 4

In this variation of Black Box No. 3, which appeared in the September 1961 issue, any number of cells may be connected to the box as shown. Whether the cells are connected in series or in parallel, the current will be the same. What is in the box?—Douglas A. Gamme

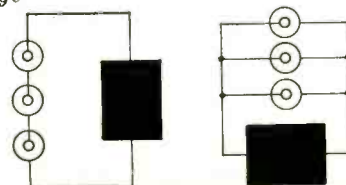

NEW

From a deluxe

VTVM to a VOM with the flick of a switch!

Typical examples where a VTVM performs best . . .

- minimum circuit loading
- very high resistance measurement
- measuring peak to peak voltage
- alignment, AGC trouble shooting or ratio detector touch up
- reading 2nd anode voltage
- transistor radio voltage measurements

Typical examples where a portable VOM is best . . .

- instant action when you can't wait for warm up and stabilization. The VTVM can be warming up while you are using the VOM.
- working on a hot TV chassis
- checking anything remote where power isn't available such as antennas, auto, etc.
- reading DC current

And look at these specifications!

Voltage

6 AC and DC ranges from 0 to 1000 volts on both VTVM and VOM
 6 peak to peak ranges from 0 to 2800 volts peak to peak on VTVM
 Zero center scale on VTVM

Resistance

6 ranges from 0 to 1000 megohm on VTVM
 2 ranges from 0 to 1 megohm on VOM

Current

one easy reading scale from 0 to 1000 milliamp on VOM

Batteries

one 1.5 volt "D" cell

Accuracy

3 percent on DC volts; 5 percent AC volts with a 6 inch, 200 microamp, 2 per cent meter.

Circuit Loading

10 megohms on VTVM, 15,000 ohms on VOM low range, 5 megohms on highest range.

Special Servicing Features for the Man on the Go!

Unbreakable steel case and protective removable cover. No leads to drag or line cord to "hank".

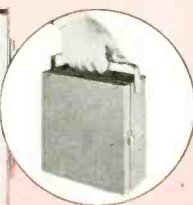
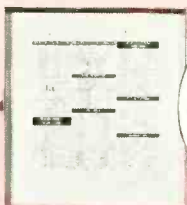

Inside the cover is a real surprise: short cut technical data to make every job easier and faster . . . standard transformer lead color code, fuse resistor burn out voltage, transistor testing guide, etc.

For the First Time in Electronic History . . . a VTVM with laboratory accuracy for bench, lab, or anywhere 115 volt AC current is available . . . flick the function switch and it's a portable VOM that you can use anywhere, anytime.

Look! Another Sencore first . . . automatic scale indication. What a time saver! Rotate the controls and watch the indicating lights follow you. You can't go wrong!

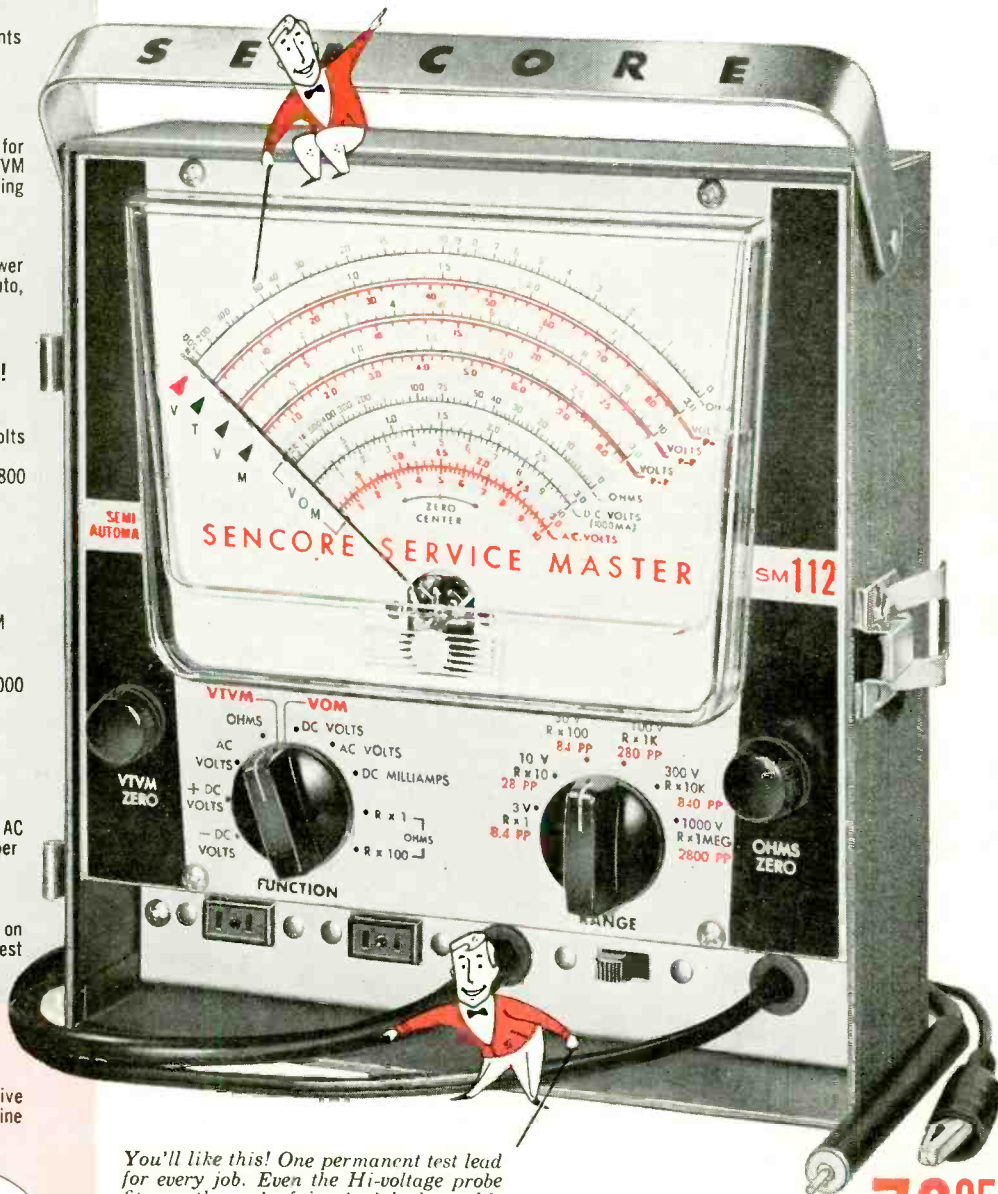

You'll like this! One permanent test lead for every job. Even the Hi-voltage probe fits on the end of it. And look at this storage compartment for test lead and line cord. The two 115 volt AC outlets sure come in handy on service calls!

79⁹⁵

Model SM112 Only
 No more than a complete VTVM alone!

Ask your Sencore distributor for the New Combination VTVM-VOM - there is no other!

MADE IN AMERICA



SENCORE

ADDISON, ILLINOIS

Including the tuner you'll find only 10 tubes in this TV receiver



TV SET USES 6 COMPACTRONS

By T. E. DUVALL*

THE NEW MUNTZ MODEL 19 MET TV RECEIVER is designed around General Electric's new 12-pin multi-function compactrons and is intended for use in metropolitan areas.

While the set is designed to operate within 50 miles of the transmitter, using a standard outdoor antenna, field tests have shown adequate performance with indoor antennas in most areas.

Power consumption is about 80 watts. This permits it to run cool and leads to long life for components. The receiver uses a 92 degree deflection system with a 19-inch picture tube.

The six compactrons in the 19 Met are two 6J11 twin pentodes; a 6AV11 triple triode; a 6GE5 horizontal output; a 6GF5 beam pentode, and a 6AX3 damper diode. Four standard tubes complete the tube complement—a 5FG7 oscillator-mixer, a 2FS5 rf amplifier, a 1K3 high-voltage rectifier and the picture tube.

*Chief engineer, Muntz TV, Inc.

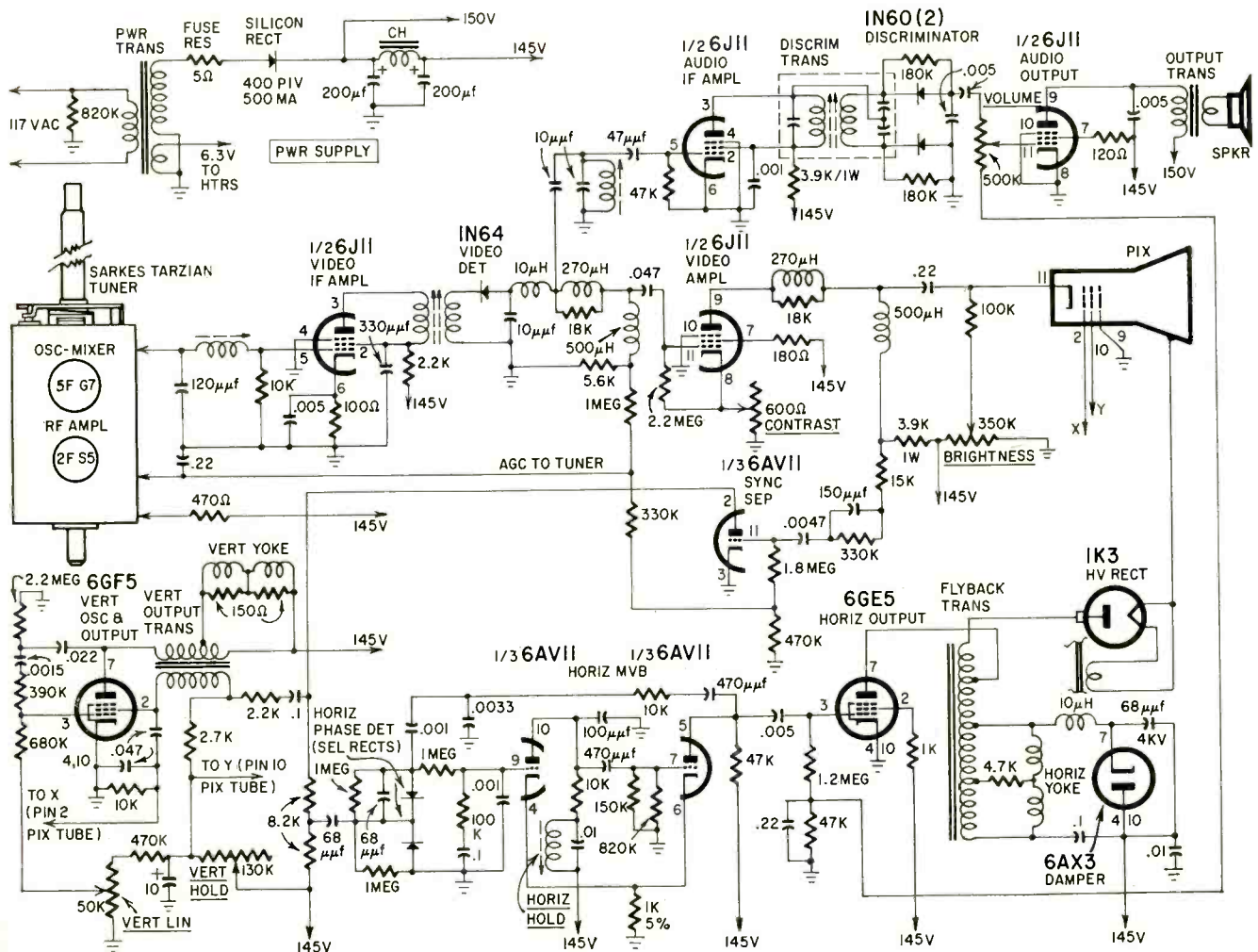

Circuit of the Muntz receiver. The tuner is a standard Sarkes Tarzian unit and its circuitry is not shown.

FREE!

LAFAYETTE

340 PAGE 1962 ELECTRONICS CATALOG

"America's Hi-Fi & Electronics Shopping Center"

Yours free for the asking — the biggest, best and most comprehensive catalog in the 41-year history of Lafayette Radio. Audiophile, Experimenter, Hobbyist, Technician, Engineer, Student, Serviceman, Dealer — you'll find what you want in this latest Lafayette catalog.



CATALOG # 620

NEW!



NEW! CB TRANSCEIVER with 8 CRYSTAL CONTROLLED CHANNELS.
HE-208 109.50



CB "WALKIE-TALKIE" CRYSTAL CONTROL RECEIVE AND TRANSMIT.
HE-29AL Net 39.95
2 for 78.88



10,000 OHMS-PER-VOLT MULTITESTER
TE-10 9.95

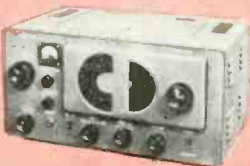

SUPERHETERODYNE COMMUNICATIONS RECEIVER
KT-200, Kit 64.50
HE-10, Wired 79.95



FM MULTIPLEX ADAPTOR Kit. Fits wide-band tuners with or without MPX output jacks.
KT-220 Net 19.95

NEW!



CITIZENS BAND MOBILE ANTENNA WHIP
HE-800WX 6.95

LARGEST STOCK SELECTION. Stereophonic Hi-Fi equipment, Citizens Band, Ham and Amateur equipment, Radio & TV parts, Optics, Industrial Supplies, and much more, including all the favorite name brands.

LAFAYETTE EXCLUSIVES. Featured are the famous Lafayette Kits . . . dollar for dollar the best value for your money today. You'll also see hundreds of Lafayette specials . . . available only from Lafayette. And, as always, **SATISFACTION GUARANTEED OR MONEY REFUNDED.**

LOWEST PRICES. You'll save money too with Lafayette's low, low prices. The lowest prices are always in the Lafayette catalog.

24-HOUR SERVICE. Quick, courteous service is your guarantee at Lafayette. Most orders are fully processed within 24 hours after receipt in the mail Order Division.

NEW EASY-PAY PLAN.
Now, **NO MONEY DOWN . . .**
up to 24 months to pay.

LAFAYETTE'S

NEW MAIL ORDER and SALES CENTER
111 JERICHO TURNPIKE
(2 Blocks West of South Oyster Bay Rd.)
SYOSSET, LONG ISLAND, NEW YORK



LAFAYETTE RADIO DEPT. JD-2
P.O. BOX 10, SYOSSET, L. I., N. Y.

- Rush my FREE Lafayette 1962 Catalog 620
 Please send me # _____, shipping charges collect.
I am enclosing \$ _____.



340 PAGES

Name _____
Address _____
City _____ Zone _____ State _____

**ANATOMY CLASS FOR DOCTORS
OF RADIO AND TV**

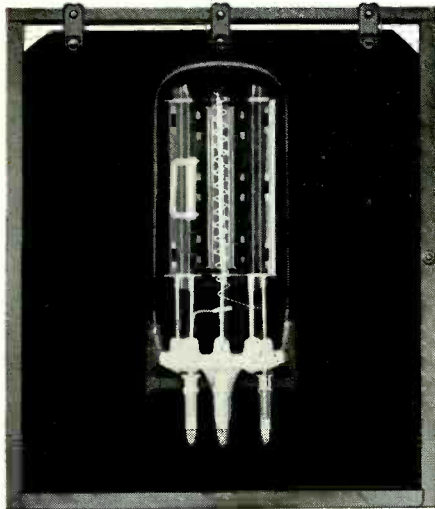

**DAMPER TUBE
EXHIBITS TOLERANCE
OF HIGH VOLTAGES**

Thorough examination of the subject reveals physical characteristics conducive to exceptional longevity. Immunity to the high voltage ailments that plague so many less rugged damper tubes is due mainly to unusual care attending the tubes' formative stages. Outstanding qualities are noted in electrophoretically coated heater peaks and insulator coils; a "cool" running cathode; a copper core plate designed for maximum dissipation and less back emission. All of these minimize arcing. In addition, the electrically isolated insulator coil maintains high voltage insulation with the shortest possible warm-up time.

JUST WHAT THE DOCTOR ORDERED

All modern damper tubes trace their genealogy directly to improved designs created by Tung-Sol. Where diagnosis of a customer's TV set indicates damper tube replacement, be sure to prescribe Tung-Sol. These are some of the more popular Tung-Sol damper tubes: 6/12AF3; 6/12/17AX4GTB; 6/19AU4GTA; 6/25W4GT; 6DA4A; 6DE4; 6V3A; 12D4A



TUNG-SOL
the first name to ask for when ordering
DAMPER TUBES

TUNG-SOL ELECTRIC INC., NEWARK 4, N. J.

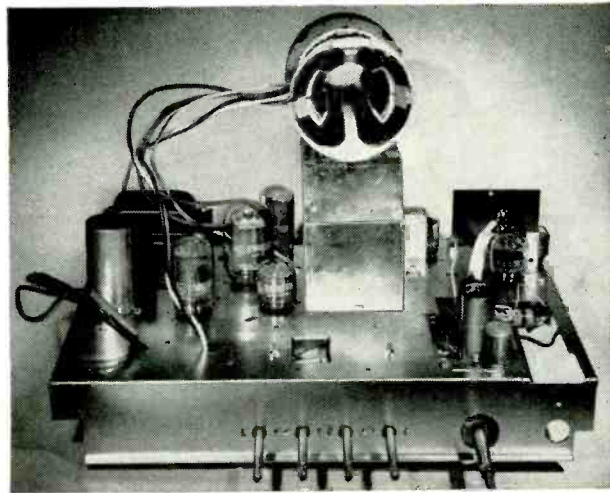

Chassis view of Muntz 19 Met. It drives 19-inch picture tube.

The tuner is a switch type made by Sarkes Tarzian.

The output of the mixer is coupled to the i.f. amplifier through low-side capacitance coupling. The i.f. transformer is double tuned and passes the i.f. signal to a conventional video detector. The detector circuit includes a tweet filter along with series and shunt video peaking. Age is derived from the detector load, additional assist voltage being obtained from the sync separator grid. Only the rf amplifier in the tuner is controlled by this voltage.

The audio i.f., half of a 6J11, gets the 4.5-mc signal from the video detector and drives a Foster-Seely discriminator that uses two 1N60 germanium diodes for the rectifiers. The detected audio is applied direct to the audio output tube. It is operated with a grounded cathode and obtains its bias by taking a portion of the horizontal output amplifier grid bias and applying it through the bottom end of the volume control.

The video signal from the video detector is amplified through the video amplifier and applied to the cathode of the picture tube. This CRT is a new design that employs a low cutoff voltage of approximately 25 volts. The CRT grid is connected to the vertical retrace blanking network. Grid 2 is operated at approximately 27 volts obtained from the voltage source for the screen grid of the vertical circuit. The focus voltage required is approximately zero and the focus electrode is therefore connected to chassis ground.

The sync separator gets its signal from the plate load of the video amplifier and supplies negative sync for the vertical and horizontal circuits.

The vertical oscillator and output is a self-oscillating type. This circuit is connected between the plate and screen grid and oscillates because of the phase relationships of the plate and tertiary (screen grid) windings on the vertical output transformer. The resistance-capacitance networks between the plate and control grid serve as wave-shaping networks for the inverse feedback voltage going to the control grid. This voltage helps shape the current flowing through the vertical output transformer

and thus controls the vertical linearity. The vertical hold control is part of a voltage-divider network from B-plus to ground. The control grid voltage can be changed a small amount with this control, thus varying the operating point of the tube and changing the operating frequency.

The vertical output (height) is controlled by changing the screen grid voltage of the tube. Vertical sync pulses from the sync separator are applied to the screen grid through the tertiary winding, thus keeping the circuit synchronized to the incoming signal.

Horizontal sync pulses are applied to an unbalanced phase detector using a pair of selenium diodes to develop the afc control voltage for the horizontal multivibrator.

The output wave-shaping network supplies the comparison voltage for the horizontal phase detector and shapes the drive signal for the horizontal output amplifier. The adjustable ringing coil core acts as the horizontal hold control.

The horizontal output amplifier drives a flyback transformer to provide approximately 14 kv at the cathode of the high-voltage rectifier. A 6AX3 compactron acts as the damper. END

**Test Speakers
Before Buying Them**

A NEW PLAN INTRODUCED BY ACOUSTIC Research (AR Inc.) will make it possible to test loudspeakers in your own home before buying them.

Acoustic Research has instituted a rental plan under which any model speaker or stereo pair can be rented from the dealer for a week, for \$1.00 per unit. If the speaker is purchased, the dollar is applied toward its price. Authorities and hi-fi enthusiasts have long agreed that a speaker may sound much different at home than in the showroom. While speaker manufacturers know this, never before has one of them attempted to do something about it.

EQUIPMENT REPORT

single instrument for color servicing

*With this color bar/dot/crosshatch generator
and a degaussing coil you're all set for color*

By **WAYNE LEMONS**

RCA RECENTLY INTRODUCED A NEW combination instrument for the setup and service of color sets. It is a color bar/dot/crosshatch generator (model WR-64A) and outside of a degaussing coil, is the only instrument needed to enter the color service field. Field reports on the WR-64A are good. It is stable and easy to operate, and the lines and dots are exceptionally sharp and well defined.

It is fixed-tuned to channel 3, and the output cable connects to the antenna terminals of the color set. If channel 3 in your area causes beat interference—and it has to be strong to do so—you can adjust the WR-64A to channel 4 without much trouble.

Color bars are produced using the "offset-subcarrier" principle. The subcarrier frequency is 15,750 cycles below the color burst frequency of 3.579545 mc (usually referred to as 3.58 mc). This results in a 1-cycle difference frequency for each horizontal scan line, or 0° to 360°, and a "rainbow" color display on the TV screen. A rainbow pattern isn't too useful since the colors run together and do not pro-

duce distinct outlines. To get color bars, the WR-64A "gates" the rainbow pattern with narrow brightness pulses. The bars are then useful for checking brightness registration (fit). With this constantly available color signal you can check all color sets for phase (hue) and matrix, and align automatic frequency and phase circuits. Also, you can demonstrate to the customer the ability of the set to receive color when no color program is available.

The DOT position of the generator can be used for color convergence, especially center convergence. Since the dots are very small and stable, you can actually evaluate, after some experience, the quality of receiver alignment by interpreting the black edging preceding and following each dot (pre-shoot and overshoot).

The CROSSHATCH pattern has extremely well defined lines. Since the number of lines is fixed, both horizontally and vertically, it is easy to judge the correct amount of raster overscan. Overscan is required in all sets for best convergence.

Because the lines are sharp and stable, you can do all color convergence



Specifications for RCA WR-64-A

Output:	
Frequencies	61.25 mc (channel 3 video carrier) 65.75 mc (channel 3 audio carrier, unmodulated)
Voltage	.05 maximum (video carrier) .005 maximum (audio carrier)
Horizontal sync	15,750 cycles
Color subcarrier	3.563795 mc, keyed at 189 kc
Output impedance	300 ohms (approximately)
Test Patterns	color bar dot crosshatch
Dimensions	13½ x 10 x 8 in.
Weight	13¼ lbs.
Price	\$189.50

**NOW
YOU CAN BUILD
A FINE
Schober Organ
FOR ONLY
\$550**



You can assemble this new Schober Spinnet Organ for \$550 — or half the cost of comparable instruments you have seen in stores. The job is simplicity itself because clear, detailed step-by-step instructions tell you exactly what to do. And you can assemble it in as little as 50 hours.

You will experience the thrill and satisfaction of watching a beautiful musical instrument take shape under your hands. The new Schober Electronic Spinnet sounds just like a big concert-size organ — with two keyboards, thirteen pedals and magnificent pipe organ tone. Yet it's small enough (only 38 inches wide) to fit into the most limited living space.

You can learn to play your spinnet with astounding ease. From the very first day you will transform simple tunes into deeply satisfying musical experiences. Then, for the rest of your life, you will realize one of life's rarest pleasures — the joy of creating your own music.

For free details on all Schober Organs, mail the coupon now. No salesman will call.

THE *Schober Organ* CORPORATION

43 West 61st Street, New York 23, N. Y.
Also available in Canada and Australia.

MAIL THIS COUPON TODAY

The Schober Organ Corporation
Dept. RE-18
43 West 61st Street
New York 23, New York

Please send me FREE booklet and other literature on the Schober Organs.

Please send me the Hi-Fi demonstration record. I enclose \$2 which is refundable when I order my first kit.

Name.....

Address.....

City..... Zone... State.....

Only **ZENITH**

EXCLUSIVE

HANDCRAFTED

NO PRINTED
CIRCUITS

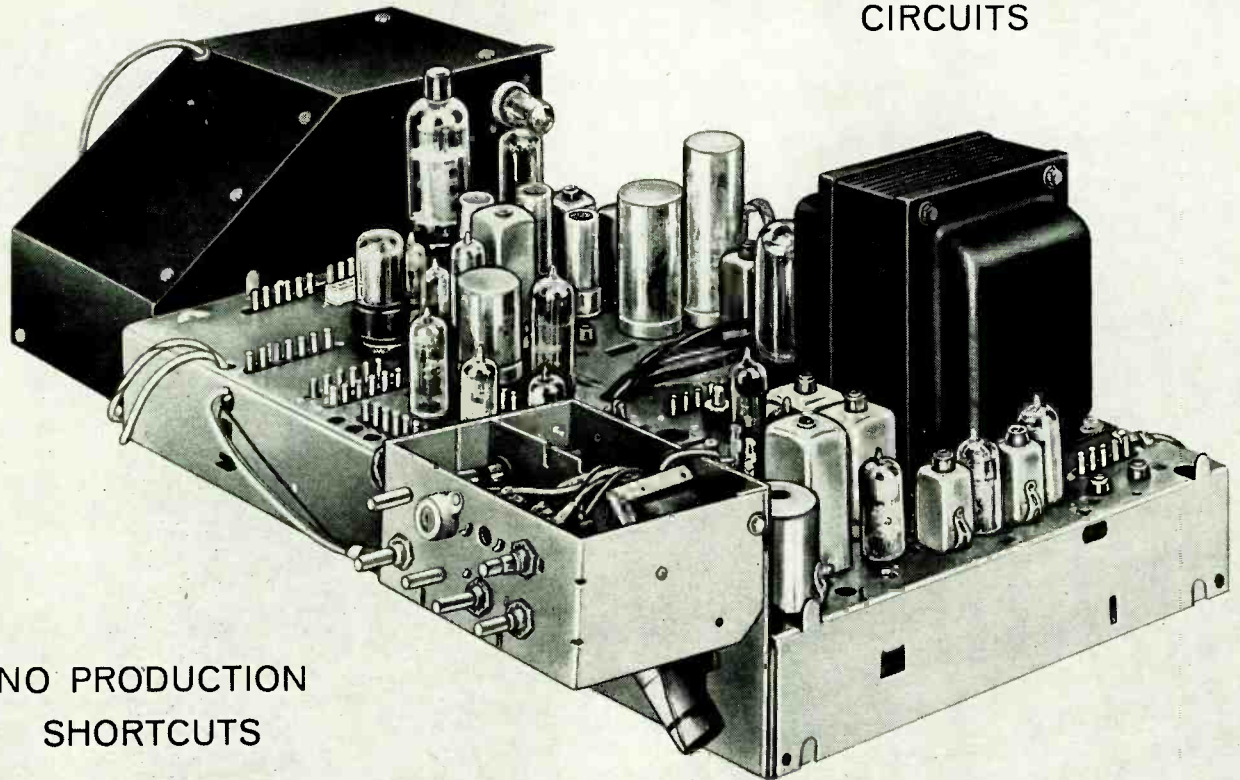

NO PRODUCTION
SHORTCUTS

**There are only two kinds of color TV made in America—
ZENITH AND ALL OTHERS!**

Now Zenith brings you the easiest-to-service color TV ever made, with the only handcrafted horizontal Service Saver color TV chassis in the industry. No printed circuits! No production shortcuts!

Every connection is hand wired and hand soldered! Mechanical design is simplified—electrical circuitry is straight-forward for greater dependability and easier, faster servicing.

*EVERY ZENITH COLOR TV IS EXCLUSIVELY DESIGNED,
DEVELOPED AND MANUFACTURED BY ZENITH!*

has it!

COLOR TV CHASSIS!

For greater dependability... simplified servicing
90% OF CHASSIS ACCESSIBLE FOR SERVICING
without removing it from the cabinet!

ONLY HANDCRAFTED ZENITH
has the "easy service" bottom plate!

When this plate is removed, 90% of the chassis is accessible for servicing without taking it out of the cabinet. Saves time and effort! Even the back of the cabinet is specially designed to come off in seconds with just 5 easy-turn clips—no screws!

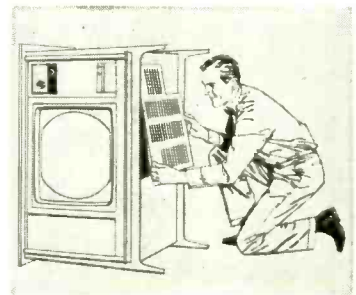

ONLY HANDCRAFTED ZENITH
has metal cone circuitry check points!

Metal cone circuitry on the new Zenith Color TV chassis makes a majority of test points accessible on top of the chassis. You do not have to remove the chassis from the cabinet. Makes servicing easier, faster, less costly!

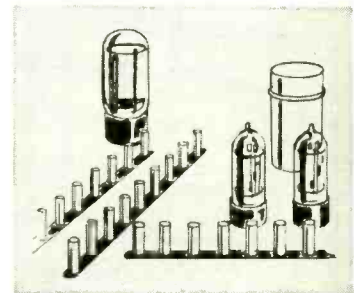

Zenith's Special Training Program assures you an important role in the future of color television!

Zenith Distributors are conducting special color TV training programs now, and will continue these programs in the future. For complete information, see your Zenith Distributor.



ZENITH RADIO CORPORATION,
CHICAGO 39,
ILLINOIS. IN CAN-
ADA: ZENITH RADIO CORPORATION OF
CANADA LTD., TORONTO, ONTARIO.
The Royalty of television, stereophonic
high fidelity instruments, phonographs,
radios and hearing aids. 43 years of lead-
ership in radionics exclusively.
Specifications subject to change without notice

ZENITH®

*The quality goes in
before the name goes on*

work, even dc, using only the cross-hatch if you wish.

How the WR-64A works

A crystal-controlled 189-kc master oscillator feeds pulses to blocking-oscillator counters that divide the 189 kc down to the other required frequencies—15,750 cycles for horizontal sync, 300 cycles for horizontal lines, and 60 cycles for vertical sync (Fig. 1). The pulses are clipped, shaped and fed to a 6AZ8 mixer which in turn drives a 6CS6 that modulates the output of a 6BQ7 rf oscillator tuned to channel 3 (or 4).

A 4.5-mc oscillator beats against the rf oscillator in the PATTERN + SOUND position of the FUNCTION switch. This is used to adjust the color set's fine-tuning control accurately.

The color subcarrier oscillator is crystal-controlled at 3.563795 mc. This signal and the 189-kc signal are combined in a 6AZ8 keyer-shaper. The 189-kc signal, after it has been shaped here, provides the 10 separate color bars at 30° intervals. Fig. 2 shows the

color bars in their correct order and phase. This display is reproduced on the WR-64A face for quick reference.

How to use the WR-64A

Because adjustment of the fine-tuning control on the receiver is important when checking a color set, a fine-tuning reference signal is supplied by the instrument. To use, you simply turn the PATTERN switch to COLOR BARS. Turn the FUNCTION switch to PATTERN + SOUND; CHROMA control to 100%. Turn the receiver fine tuning until the sound carrier blanks out the color bar pattern. Then, turn the fine tuning back until the sound interference just smoothes away. This, of course, is exactly how you adjust the fine tuning when tuning in a station.

To set the HUE control on a color set, leave as above but move the FUNCTION switch to PATTERN; adjust the hue (or tint) control on the set until the eighth bar in the pattern is cyan (blue-green). Moving the hue control in one direction should make the eighth bar turn bluer, while moving it in the other

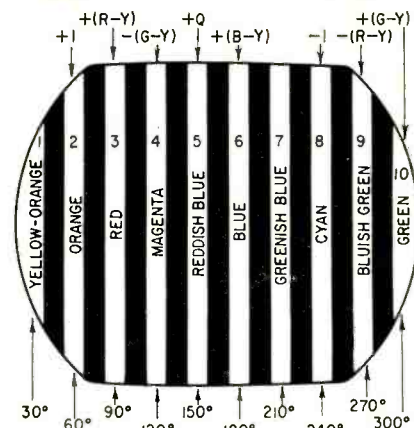

Fig. 2—Here's the color bar pattern the generator produces.

direction should make it turn greener. To check color sync action, you can get valuable information by manipulating the CHROMA control on the WR-64A. "100%" represents normal color sync burst amplitude. To check for color-lock ability of the set, turn the

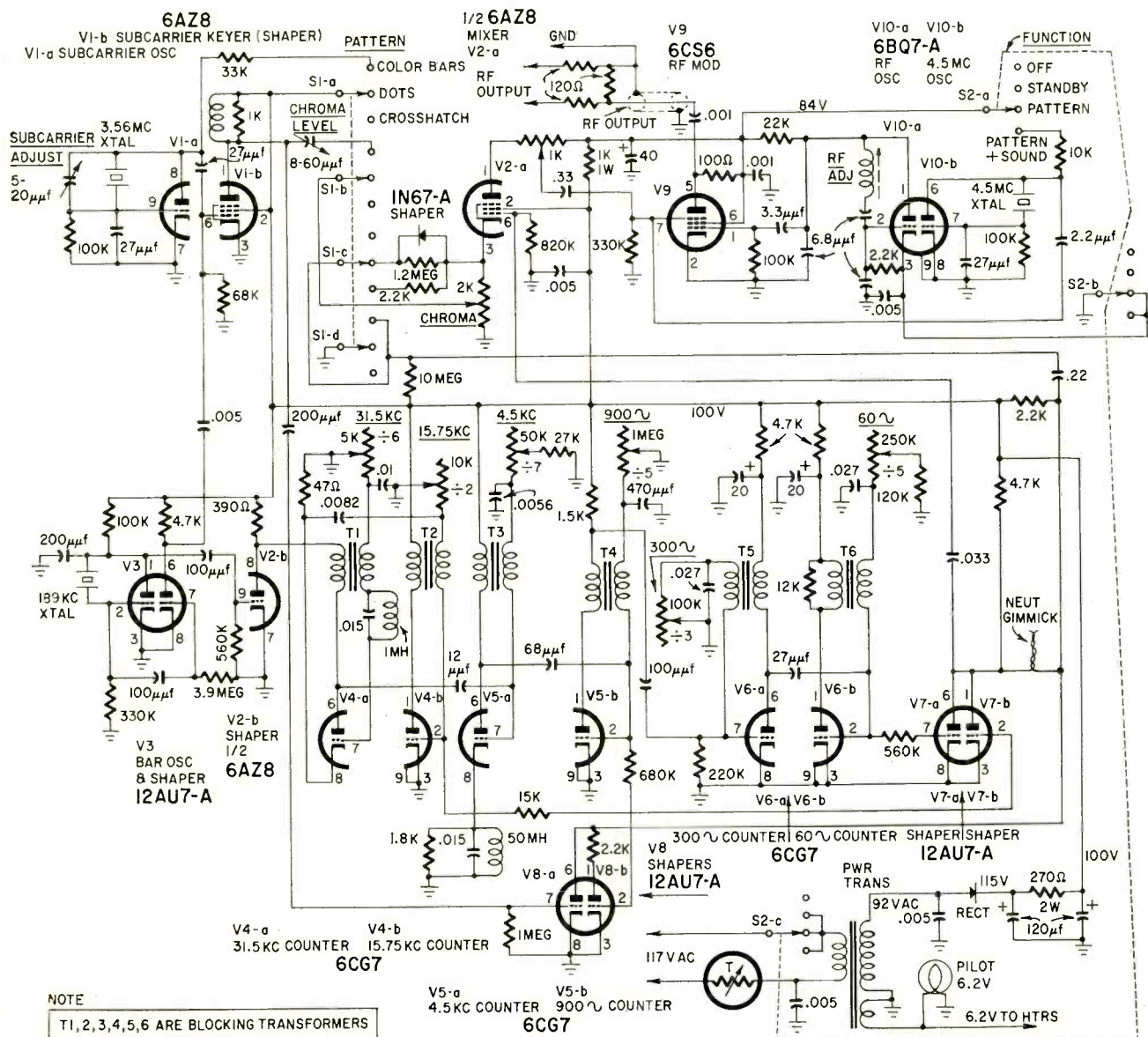

Fig. 1—Schematic of the RCA WR-64A.

CHROMA control slowly toward zero. The colors should become pale and finally disappear. Most receivers should hold the colors locked in until the colors fade away or until just before that. If the color loses color sync with only a small reduction in chroma amplitude, it indicates there is trouble, probably in the color sync section of the receiver.

To help diagnose troubles in the chroma section of a set, the CHROMA control can be used to increase the amplitude of the color sync up to 200%. This will help you to drive a signal through a weak or misaligned stage so that you can get some idea of which way to look for trouble.

When color bars are displayed on the screen, if the colors lap over into the blank spaces between the bars (colors don't fit), it probably indicates a defective delay line or incorrect alignment of the bandpass amplifiers.

All in all, the RCA WR-64A represents a distinct advance in instruments for servicing color receivers of all kinds. END

UNIUNCTION PILOT LAMP

Transistor equipment designers generally run into the problem of providing a visual on-off indicator. A type 47 pilot lamp draws around 900 milliwatts—far more than the power consumed by many battery-powered transistor devices. Here is a simple

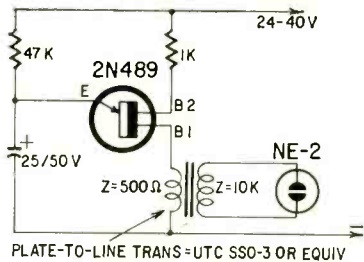

low-power pilot-lamp circuit for transistorized equipment operating from 24-40-volt batteries. Power drain is reduced by using a flashing indicator with a short-duty cycle.

The circuit (see diagram) uses a 2N489 unijunction transistor as a low-frequency pulse generator. The generator output is stepped up by the transformer and applied to a NE-2 neon lamp, causing it to flash.

In operation, the capacitor charges through the 47,000-ohm resistor until the voltage across it reaches the critical value, which is from 0.51 to 0.62 times the supply voltage (this figure varies with the particular type of unijunction transistor used). When this voltage is reached, the transistor turns on and the capacitor discharges rapidly to ground through the transistor and transformer. The resulting stepped-up pulse fires the neon lamp. The indicator flashes about once each second and draws from 3.2 ma at 24 volts (77 mw) to 5.5 ma at 40 volts (220 mw). The light flash is just noticeable in a lighted room with a 24-volt supply and readily perceptible at 30 volts.—Paul S. Lederer

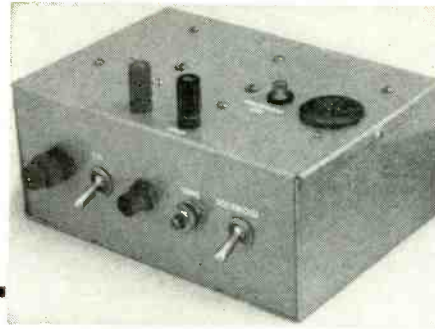

Sensor controls liquid levels

Two-transistor unit maintains the level of any conductive liquid

By S. A. ERCEG and N. J. CHERVENAK

Used with a sensing probe and a solenoid-operated valve, this device automatically regulates the level of a liquid in a container, prevents the accumulation of excess foam in a vat or performs any number of similar regulating jobs. Upon sensing a predetermined level of liquid or foam, the device applies 117 volts ac to the valve solenoid. Depending upon the particular application, the valve may be rigged to close when solenoid is energized and shut off the incoming flow of liquid to a container, or the valve may be rigged to open and allow the flow of an antifoam agent into a vat.

The sensing unit was developed for use in a pilot-plant operation to control the level of foam in a tall cylindrical tank. The contents of the tank are agitated by introducing compressed air at the bottom. Considerable foam is thus created and the height to which it rises must be controlled with a liquid antifoam material. The sensing unit is connected to a probe in the tank which detects the foam level when the probe contacts it. If the foam reaches the probe, the sensor causes a solenoid valve

on a container of antifoam material to open so the material can flow into the tank. As soon as the material reduces the foam below the probe, contact is broken and the solenoid valve shuts off.

It was desired to start the entire operation several hours before personnel arrived in the morning. A timing system could turn on air to agitate the tank contents, but control of the foaming with minimal amounts of antifoam material was a problem until the sensing unit was installed.

How it operates

The schematic is self-explanatory for the most part. The B-plus supply is noncritical. The approximate 18 volts dc provided by the filament transformer and simple voltage doubler does the job. When power switch S1 is closed, 117 volts ac energizes the power supply and is applied to an open contact on the relay and to one side of receptacle J1. A neon lamp indicates power on. The solenoid is plugged into receptacle J1. Black sensing jack J3 is connected to the liquid container which should be grounded. A sensing probe, insulated

Complete schematic of the device.

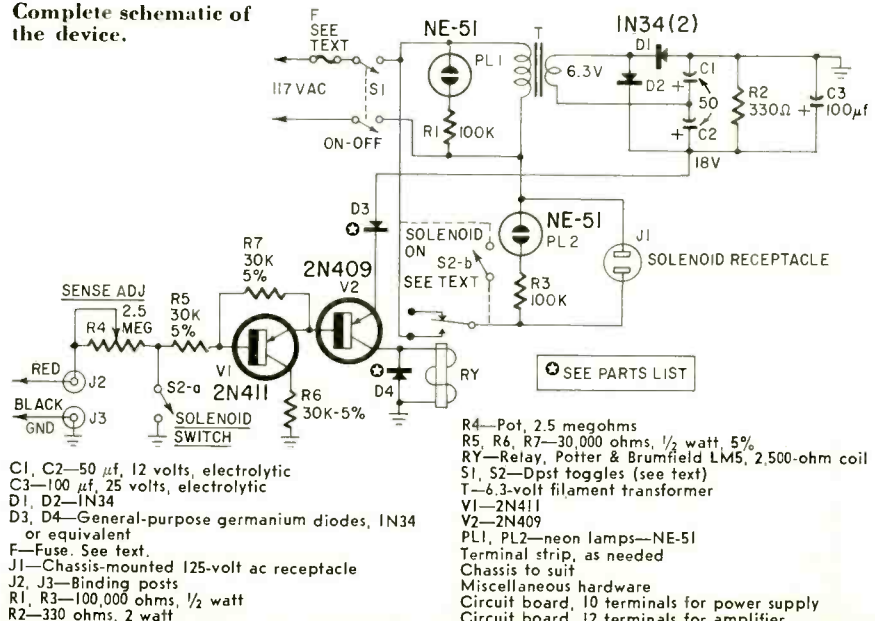

**"ASTONISHING!"
"EXCELLENT!"
"TERRIFIC VALUE!"**



Unfinished

CABINART SPEAKER SYSTEMS

Acoustic damping material inside.

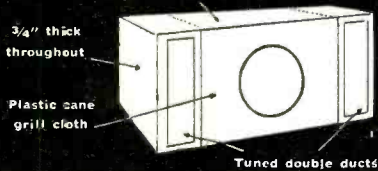

3/4" thick
throughout

Plastic cane
grill cloth

Tuned double ducts

mark I 8" model
11" H x 9 1/2" D x 23" L,
Shipping Wt. 27 lbs.
Sculptured Front Walnut
Veneer, Oiled Finish \$30.00
FOB Factory

\$18⁰⁰
Unfinished

Extended range domestic speaker, new hi-efficiency magnetic circuit. Ideal for med. & low level monaural or stereo reproduction. 1" voice coil, 8 ohms impedance. Speaker resp. 45 to 13,000 cps. 3.16 oz. new type magnet. Nominal power rating 10 to 15 watts.

mark II 12" model
14" H x 11 1/2" D x 23 3/4" L,
Shipping Wt. 37 lbs.
Sculptured Front Walnut
Veneer, Oiled Finish \$43.20
FOB Factory

\$27⁰⁰
Unfinished

12" coaxial 6.8 oz. Alnico V magnet with 1" voice coil, heavy 1-pc. cone and specially designed 3" Alnico V PM tweeter mounted coaxially with built in hi-pass filter, capacitor type. Power rating 15 watts; imp. 8 ohms. Speaker resp. 40 to 15,000 cps.

Cabinart Cabinets are made of extremely dense pressed wood, unfinished. Walnut models are genuine hardwood veneers with superlative finish. Extra heavy 3/4" thick construction, solidly glued, achieves maximum speaker response. Unique principle of acoustic resistive loading effectively improves low end response for balanced full fidelity reproduction. Each system tuned, double ducted, acoustically insulated.

"Astonishing!" says E. T. Canby in Audio, Nov. '61. Send for FREE re-print article on Cabinart speaker systems.

AVAILABLE AT YOUR DEALER OR ORDER DIRECT FOR IMMEDIATE DELIVERY

CABINART GUARANTEES

You must be satisfied for 10 full days or your money back.

ONE FULL YEAR WARRANTY

Written registration card and warranty included.

CABINART ACOUSTICAL DEV. CORP.

32 Geyer St., Haledon, N.J.

Please ship the following to be used in my home for 10 full days. I understand unit (s) may be returned and my money refunded within that time unless fully satisfied.

- Mark I Unfinished \$18.00 each
- Mark II Unfinished \$27.00 each
- Mark I Oiled Walnut \$30.00 each
- Mark II Oiled Walnut \$43.20 each

(Please make check or money order payable to Cabinart Acoustical.)

Name _____
Address _____
City _____ State _____

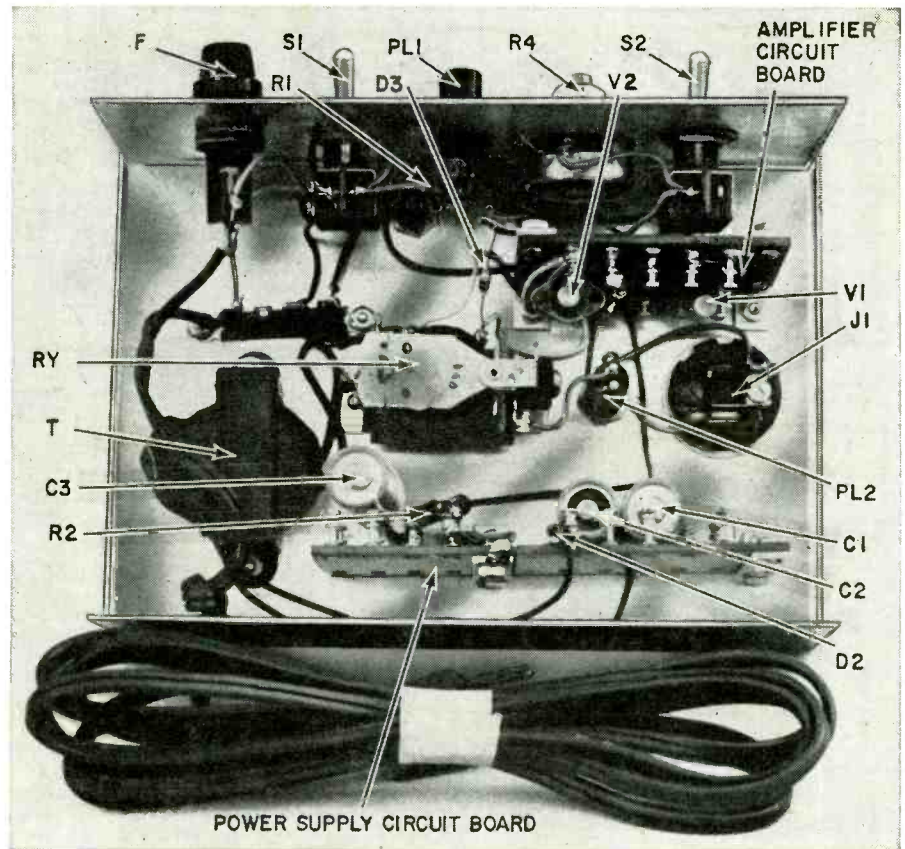

POWER SUPPLY CIRCUIT BOARD

Underchassis view of the instrument.

from the container and positioned to make contact with the liquid at the proper level, is connected to red sensing jack J2. When the liquid contacts the probe, the two-transistor amplifier is turned on. The relay is then energized and applies the 117 volts ac to J1 to energize the solenoid. A neon lamp then indicates that the solenoid is energized.

Diode D4 connected across the coil of the relay protects V2 by absorbing the voltage surge when the relay de-energizes. Resistor R7 and diode D3 provide temperature compensation for V1 and V2, respectively. The absence of either R7 or D3 may allow the transistor leakage current to build up enough to energize the relay prematurely (due to the negative temperature coefficient of the transistors).

Components and modifications

Major components requirements are very flexible. Any high-beta low-leakage (on the order of 2 or 3 microamps) transistors may be used. Transistors used in the circuit shown in the schematic are p-n-p types. If n-p-n transistors are used, simply reverse the output of the power supply and reverse the polarity of diodes D3 and D4.

Another consideration is that the fuse and relay be compatible with the power rating of the solenoid used. The relay contacts must be able to handle the current drain of the solenoid, and the fuse should be chosen accordingly. For example, if a 117-volt ac solenoid rated at 50 watts is used, its current drain is 50/117, or 0.43 amp. In this case, the relay contacts should be rated

at 1 or 2 amps to insure long life, and a 1/2-amp fuse should be used. The relay used in the schematic can handle a solenoid with a current drain up to 2 amps with assurance of long life.

Switch S2 provides a means of manually energizing the relay and checking amplifier operation. Although not a part of the original design, an additional feature may be provided by using a three-position toggle switch for S2. In this case, the center position would be OFF, one ON position would function as S2-a shown in the schematic, and the other ON position would function to bypass the relay contacts as shown by the dotted line in the schematic. This switch may then be used to make a quick check of amplifier and relay operation and also to energize the solenoid through S2-b should the amplifier or relay fail.

Potentiometer R4 adjusts the sensitivity of the instrument. First adjust R4 fully counterclockwise, insert the sensing probe into the liquid, and then slowly adjust R4 clockwise until the relay energizes and the neon lamp glows.

Construction is completely a matter of choice and convenience. No component placement or heat sink requirements are critical. The schematic is easy to follow and the photographs show a suggested layout. The amplifier and power supply circuits are each wired on a separate circuit board. All other components are chassis-mounted with the exceptions of diode D4 across the relay coil and resistors R1 and R3 in series with the indicator lamps. END

NOW... RCA OFFERS A COMPLETE SELECTION OF HOME TRAINING COURSES IN ELECTRONICS



ELECTRONIC FUNDAMENTALS
40 theory lessons! 40 experiment lessons! 40 service practice lessons! Course includes 15 kits to build a Multimeter, AM Receiver and Signal Generator!

2 new courses now available

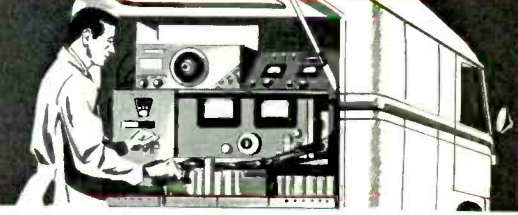

COMMUNICATIONS ELECTRONICS
9 study groups! 18 lessons! Covers oscillators, power amplifiers, AM, FM, SSB, Mobile Radio—prepares you for an FCC license!

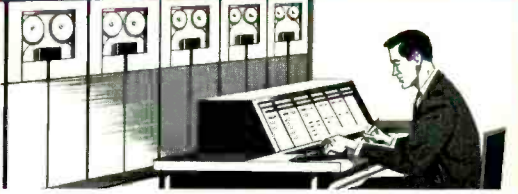



COMPUTER PROGRAMMING
5 study groups totaling 11 complete lessons, in principles and techniques of programming business computers! High School graduation and 1 year business experience required.

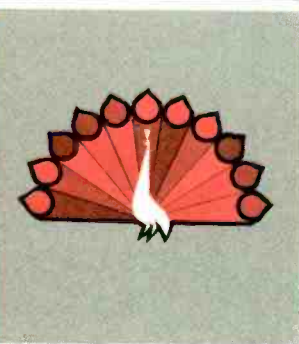

TELEVISION SERVICING
10 study groups totaling 27 lessons plus 6 complete kits for construction of a modern television receiver!

COLOR TELEVISION
4 study groups totaling 11 complete lessons! Includes the theory, installation, and servicing of modern color television receivers!

AUTOMATION ELECTRONICS
5 study units of 4 lessons each! Covers electronic devices used in industry to achieve automatic control of production systems and processes!



TRANSISTORS
5 study groups totaling 10 complete lessons! Fundamentals, operation, and construction of modern transistor and circuit devices!

Practical work begins with the very first lesson! Voluntary tuition plan! No long-term contracts to sign! No monthly installment payments. Pay only for one study group at a time if and when you order it!

Build your future in electronics now!
SEND FOR THIS FREE HOME STUDY CATALOG TODAY!



Just fill out this card and drop it in the mail. ▶

RCA INSTITUTES, INC., Dept. RE-42
A Service of Radio Corporation of America
350 W. 4th St., N. Y. 14, N. Y. • 610 S. Main St., Los Angeles 14, Calif.



The Most Trusted Name in Electronics

RCA INSTITUTES, INC., Dept. RE-42
A Service of Radio Corporation of America
350 West Fourth Street, New York 14, N. Y.
610 South Main Street, Los Angeles 14, Calif.

Without obligation, rush me the FREE 64-page illustrated book describing your electronic training program (check one). No salesman will call.

Home Study School Los Angeles Resident School
New York Resident School

Name..... Age.....
(please print)

Address.....

City..... Zone..... State.....

Veterans: Enter discharge date.....

CANADIANS—Take advantage of these same RCA courses at no additional cost. No postage, no customs, no delay. Enclose this card in envelope and mail to: RCA Victor Company, Ltd., 5581 Royalmount Ave., Montreal 9, Quebec.

RCA TRAINING CAN BE THE SMARTEST INVESTMENT YOU EVER MAKE

HOME STUDY SCHOOL

With RCA Institutes Home Study training, you set your own pace in keeping with your ability, finances and time. All equipment and components provided are brand new and of prime quality . . . and you never have to take apart one piece to build another.

Most Important To You, RCA offers a liberal Voluntary Tuition Plan—the most economical home study method available *because you pay only for lessons as you order them . . . one study group at a time!* If you drop out at *any time, for any reason*, you do not owe RCA one penny! No other obligations! No monthly installment payments! Licensed by the New York State Education Department. See reverse side for list of courses.

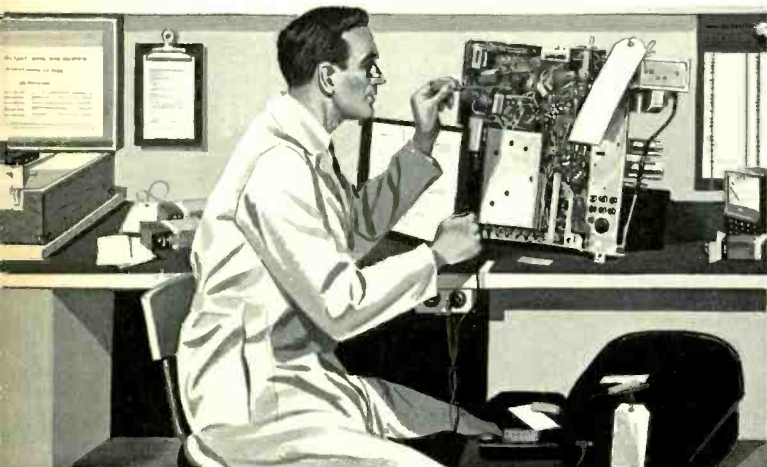

RESIDENT SCHOOLS

If you prefer you may attend classes at one of RCA Institutes Resident Schools in either Los Angeles or New York City. Co-educational Day and Evening Classes. Free placement service. The following courses are available at either resident school:

CHOOSE FROM THIS LIST . . .

	Course	Qualifications	Length of Course
A	Advanced Electronic Technology (T-3)	High School grad. with Algebra, Physics or Science	Day 2¼ yrs. Eve. 6¾ yrs. (N.Y.) 4½ yrs. (L.A.)
B	Television and General Electronics (V-7)	2 yrs. High School, with Algebra, Physics or Science	Day 1½ yrs. Eve. 4½ yrs. (N.Y.) 3 yrs. (L.A.)
C	Radio and Television Servicing (V-3)	2 yrs. High School, with Algebra, Physics or Science	Day 9 mos. Eve. 2¼ yrs. (N.Y.) 1½ yrs. (L.A.)
D	Transistors	Radio background	Eve. 3 mos.
E	Electronic Drafting (V-11 V-12)	2 yrs. High School, with Algebra, Physics or Science	Eve. Basic: 1 yr. Advanced: 2 yrs.
F	Color Television	Television background	Eve. 3 mos.
G	Radio Telegraph Operating (V-5)	2 yrs. High School, with Algebra, Physics or Science	Day 9 mos. Eve. 2¼ yrs. (N.Y.) 1½ yrs. (L.A.)
H	Computer Programming (C-1)	College Graduate or Industry sponsored.	Eve. 24 weeks Sat. 30 weeks
I	Technical Writing (V-10)	High School Graduate	Day 9 mos. (L.A.) Eve. 2¼ yrs. (L.A.) 3 mos. (N.Y.)
J	Automation Electronics (V-14)	Background in Radio Receivers and Transistors	Eve. 9 mos. (N.Y.) Sat. 44 weeks (N.Y.)
K	Digital Computers	Electronics background	Eve. 3 mos. (L.A.)
L	Preparatory Math & Physics (P-0)	1 yr. High School	Day 3 mos. or 6 mos.
M	Preparatory Mathematics (P-0A)	1 yr. High School	Eve. 3 mos.

PLACE
3¢ STAMP
HERE

Send for this FREE illustrated book describing RCA Resident Schools. Fill in the other side of the postcard and check Resident School.



RCA INSTITUTES, INC., Dept. RE-42
350 West Fourth Street
New York 14, N. Y.

RCA INSTITUTES, INC., Dept. RE-42
A Service of Radio Corporation of America
350 W. 4th St., N. Y. 14, N. Y. • 610 S. Main St., Los Angeles 14, Calif.



The Most Trusted Name in Electronics

INDUSTRIAL ELECTRONICS DICTIONARY

By ED BUKSTEIN

from self-repeating timer
to univibrator

Self-repeating timer: A time-delay circuit in which the relay contacts are used to recycle or restart the time delay. In the circuit shown in Fig. 27, capacitor C charges through resistor R, gradually increasing the positive potential at the grid. After a length of time, the positive potential at the grid increases enough to energize the relay. The relay contacts now close, discharging capacitor C. Since the grid is no longer positive, the relay de-energizes and the contacts open. Capacitor C now begins to charge again, and the time-delay cycle repeats itself.

Selsyn: A remote-positioning device combining both transformer and motor principles. The rotor of the selsyn is connected to the ac power line and, functioning as a primary, induces voltage in the stator windings. This voltage is applied through a connecting cable to the stator windings of another selsyn.

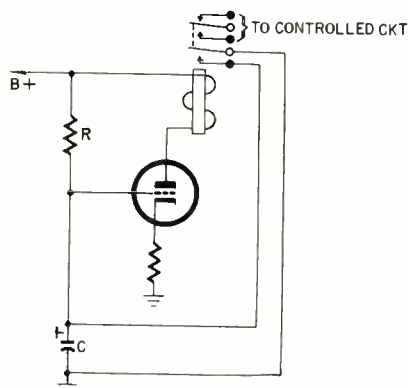

Fig. 27—The self-repeating timer recycles itself so that time delay is repeated over and over.

The resulting magnetic field established by the stator windings of the second selsyn causes the rotor to assume a position corresponding to that of the first selsyn. Therefore, one selsyn acts as a transmitter and the other as a receiver; the rotor of the receiver following any motion of the rotor of the transmitter.

Sequence timer: A succession of time-delay circuits so arranged that completion of the delay in one circuit causes the delay to begin in the following circuit. In the sequence timer in Fig. 28, the time delay in the first stage starts when the switch is opened to allow the capacitor to charge. When this capacitor has charged enough to energize the first relay, the relay contacts separate and remove the short from the capacitor in the second stage. The second capacitor now charges and the second-stage relay eventually becomes energized. The normally closed contacts now open and allow the capacitor in the third stage to charge. Three stages are shown in Fig. 28, but the circuit can be extended to a greater number. If desired, the circuit can be made self-repeating by using the contacts of the last relay to discharge the capacitor in the first stage.

Sequence timers are commonly used in resistance-welding controls to time the squeeze, weld and hold intervals (see Resistance welding).

Servomechanism: An automatic control system for maintaining some quantity at a constant value with respect to a reference quantity which may be constant or varying. In a strict sense, the term servomechanism applies when the controlled quantity is mechanical posi-

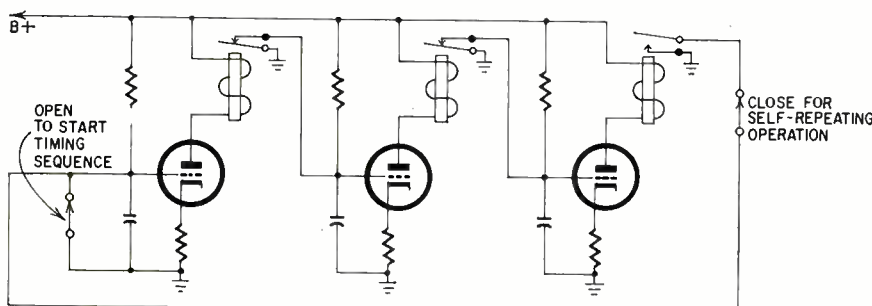
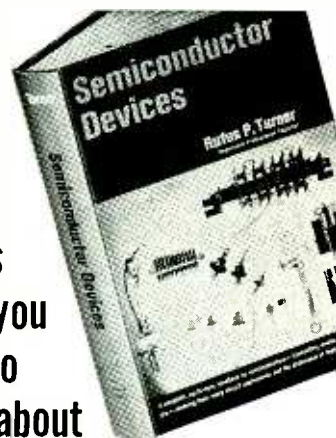

Fig. 28—Relays of sequence timer energize stage by stage. Last relay can be used to reset entire circuit.

APRIL, 1962



Here's
what you
need to
know about

SEMI- CONDUCTORS!

- DIODES • TRANSISTORS
- THERMISTORS • VARISTORS
- Power and controlled RECTIFIERS
- ZENER DIODES • PHOTO CELLS
- PARAMETRIC and MAGNETIC DEVICES, etc.

plus
using, testing and
measuring
semiconductors

Here at last is a down-to-earth 278-page book that gives you a practical working knowledge of semiconductor—from transistors to diodes, power and controlled rectifiers, ZENER diodes, varistors, thermistors, photo cells, parametric and magnetic devices and all the rest! It answers your questions about these remarkable little devices—equips you with the complete know how of their types, construction, circuit applications, testing and use.

No other field of electronics in recent years has experienced such remarkable growth. SEMICONDUCTOR DEVICES by Rufus Turner gives you a clear understanding of the entire subject—and does it without a lot of complicated mathematics. It has been specifically written for electronic technicians, servicemen, experimenters who are finding it increasingly important to have more than just a casual knowledge of these little devices which are literally revolutionizing electronic circuitry and design.

Standard and special-purpose types and their uses are fully explained. Over 250 illustrations demonstrating semiconductor circuitry and operational and construction features greatly simplify your understanding of the subject. *Of particular importance, methods of testing and measuring semiconductor devices are spelled out in detail.* Price \$7.50 on 10-day money-back guarantee basis.

.....10-DAY FREE EXAMINATION.....

Department RE-42 #623900
HOLT, RINEHART and WINSTON
P.O. Box 2334, Grand Central Station
New York 17, New York

Send Turner's big, 278-page SEMICONDUCTOR DEVICES Manual for 10-day free examination. If I decide to keep book, I will then promptly send you \$7.50 in full payment. If not, I will return book postpaid and owe nothing.

709063
(SAVE! Send \$7.50 with order and we pay postage. Same 10-day return privilege with money promptly refunded.)

Name _____

Address _____

City, Zone State _____

OUTSIDE U.S.A., \$8.00, Cash only. 10-day return privilege with money refunded.

(Above offer expires December 1, 1962)

What's Your EQ? *March Solutions*

tion, but the term is commonly used to describe any automatic control system. **Soft X-rays:** X-rays of lesser penetrating power as compared to hard X-rays. The penetrating power is determined by the amount of voltage applied to the X-ray tube: the lower the voltage the lower the penetrating power. Soft X-rays, which are longer in wavelength than hard X-rays, are used for examining low-density materials such as wood, rubber, and plastics (see Hard X-rays).

Software—in the computer field, the mathematical and programming services are referred to as *software* in contrast to the equipment itself which is referred to as the *hardware*.

Spectral sensitivity: The color response of a light-sensitive device such as a phototube.

Spot welding: A form of resistance welding employing rod-shaped electrodes (see Resistance welding).

Strain gage: A transducer used to measure strain in mechanical structures. The gage consists of a length of resistance wire attached to the structure whose strain is to be measured. As a result of the strain, the wire is stretched and becomes longer and thinner. The resistance of the gage, therefore, increases and unbalances the bridge circuit in which it is connected. The output of the bridge is amplified and applied to a meter or an oscillograph recorder.

Stroboscope: A flashing light source used for studying balance and vibration in rotating or reciprocating machinery. The flashing rate is adjusted so that the machine is in the same position each time it is illuminated, making it appear stationary.

Thyratron: A hot cathode, gas- or vapor-filled tube having a control grid. Triode and tetrode thyratrons are used extensively in industry as grid-controlled rectifiers for motor-speed and welding-current controls (see Amplitude-controlled rectifier and Phase-controlled rectifier).

Thermistor: A type of resistor having a large temperature coefficient. The thermistor is used in temperature measurement and control applications.

Thermocouple: A temperature-to-voltage transducer consisting of two dissimilar metals. The output voltage of the thermocouple is dependent upon the temperature at the junction of the dissimilar metals.

Time-delay circuit: A relay circuit so designed that the relay becomes energized (or de-energized) a length of time after a switch is closed (or opened). (See Self-repeating timer and Sequence timer.)

Transducer: A component for converting a nonelectrical quantity (temperature, pressure, etc.) into an electrical quantity. The thermistor, for example, is a temperature-to-resistance converter, the photovoltaic cell is a light-to-voltage converter, etc. Transducers are useful in industrial instrumentation and control systems.

Univibrator: Same as *one-shot multivibrator*.

TO BE CONTINUED

Half Speed TV

It sure does look as though a defective part should affect the dc voltages. However, R304, the 220,000-ohm resistor in the "output" plate of the 6SN7 multivibrator measured almost exactly 470,000 ohms instead of the normal 220,000! This was changing the time constant of that circuit so that the oscillator ran at half-speed. What about the dc voltages? We replaced the defective resistor and measured again, just to be certain: with either a good

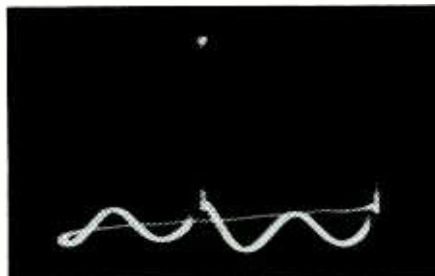

Waveform found on plate of Du Mont horizontal oscillator, pins 2 and 4. Too many wiggles for the number of spikes! Last month we showed you the correct waveform by mistake. (See Mar., p. 57).

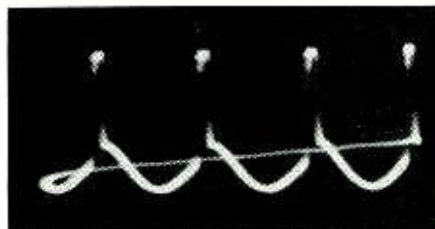

This is what it ought to look like! One wiggle per spike. This happens to be the one shown on the schematic, too!

resistor or the bad one, we still got 120 volts on that plate, using a vtvm.

Explanation: due to the very small fraction of the time that this plate is conducting, the voltage drop (dc) was not enough to show up! However, with these symptoms, and with the oscillator operating under the conditions given, there are only *nine* parts, maximum, that could conceivably affect the operating frequency! We are assuming that the tube was changed first, which it was. It must be one of the few parts left in the circuit, and it was.

Applied Voltage

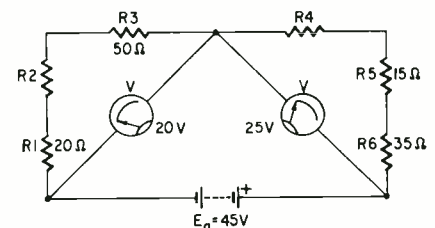

R3 equals R5 + R6, and will drop the same voltage. Therefore the voltage dropped across R3 and R4 will equal the voltage dropped across R4, R5 and R6. Thus it is clear that E_n is 45 volts.

What's the Component?

The component is an electrolytic (or other high-capacitance) capacitor. With the meter set for resistance, he charges the capacitor. He then switches to read voltage, and reads the voltage on the capacitor. This gives the internal battery voltage of the resistance range to which the meter was set.



"I worked on it until I finally forgot what it was I started to build."

LOOK ask DEMAND inquire ARGUE beseech INSIST

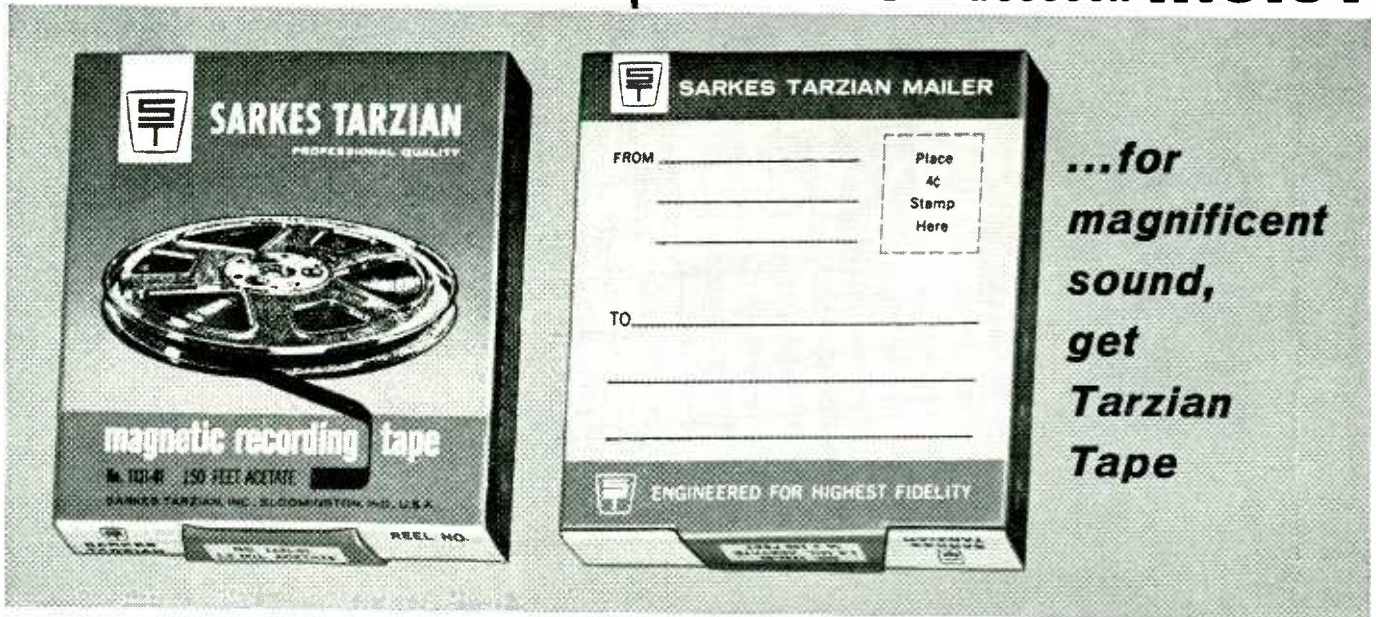

To earn a 3" reel of tape... be a surveyor for Tarzian

Tarzian Tape has been advertised since December of 1960 in publications dealers are presumed to read... since February of 1961 in publications you are presumed to read. Tape quality is excellent—our engineers say, our users say. Sales are good, but would be better if more dealers carried the line. The line is 1½ mil and 1 mil acetate tape, and 1 mil Mylar* tape, in 3", 5" and 7" reels. The price is competitive.

If you have tried Tarzian Tape or if you would like to try Tarzian Tape, here's how to get a 3-inch reel of it for no money, down or otherwise. Just ask your dealer for Tarzian Tape. If he has it, check the box and ask him what dealer publications he reads. If he does not carry it, check the box and ask him why not, and what dealer publications he reads. If he says he's never heard of it, by all means ask him what dealer publications he reads.

Send us your name and address and his name and address, and his answers and a verification by any dealer employee. We'll send you a self-mailing box (as illustrated) of 3" 1½ mil acetate professional quality Tarzian Tape. The coupon is for your convenience. Use it as a guide if you'd rather reply on some other piece of paper.

**DuPont trademark for polyester film*

Sarkes Tarzian, Inc., Dept. FLI
Magnetic Tape Division,
E. Hillside Drive, Bloomington, Indiana

Send me a 3-inch reel of 1½ mil acetate Tarzian Tape in return for the survey work shown below:

Dealer Name: _____

Address: _____

Dealer does carry Tarzian Tape
Dealer does not carry Tarzian Tape Why not?

He reads these dealer publications:

Dealer to sign this verification: The raw tape user named below got the answers shown above from me.

User name _____

Address _____



SARKES TARZIAN, Inc.

World's Leading Manufacturers of TV and FM Tuners • Closed Circuit TV Systems • Broadcast Equipment • Air Trimmers • FM Radios • Magnetic Recording Tape • Semiconductor Devices

MAGNETIC TAPE DIVISION • BLOOMINGTON, INDIANA

Export: Ad Auriema, Inc., N. Y. • In Canada, Cross Canada Electronics, Waterloo, Ont.

Measure Torque With Electronics

By A. V. J. MARTIN

UP to now, no really simple and practical method of measuring positive and negative torque with any precision has been available. This has been even more true of simultaneous evaluation of torque and rotating speed—that is, power.

In most torque measurement methods, practical installation is delicate because the torque detector or transducer rotates with the shaft. Then the signal coming from the transducer must be sent to fixed instruments. This is frequently done with a brush and slipping arrangement, which presents a number of difficulties.

In the proposed system, torque between a driving shaft and a driven shaft is detected by a deformable coupling part between shafts. This part can be made of elastic bars (Fig. 1), which take a helicoidal distortion which is function of the torque. The distance between the two end pieces varies with torque and all we have to do is measure the distance variation to find the torque.

The mechanical arrangement shown in Fig. 1 is one of the simplest possible methods. There are a number of variations designed to avoid axial forces on the shafts, increase precision, improve linearity, etc. The basic principle is to transform a torque variation into a length variation, and to measure the change in length.

Precision length measurement is comparatively easy. But in this case the parts rotate, so new methods or variants of known methods are needed. In one proposed form, the length variation produces an axial displacement of a disc which rotates in front of a fixed-position detector. The output of the detector gives the torque by direct reading. The exact details of the method vary somewhat with the particular application.

For example, in Fig. 2, the rotating and axially moving part is a ferrite-cone magnet. It has alternate N and S poles as shown in Fig. 3, and rotates in front of two magnetic cores carrying windings. The alternating energy pro-

All it takes is the right transducer and a 2-transistor circuit

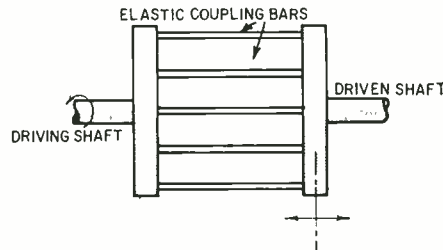

Fig. 1—Torque is transformed into an axial variation of length by elastic coupling bars.

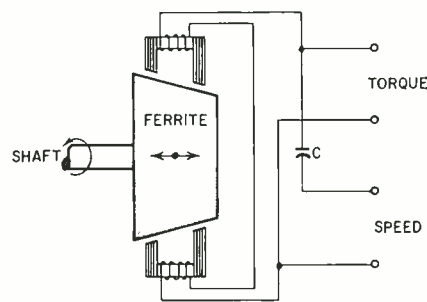

Fig. 2—Displacement detector using a ferrite cone.

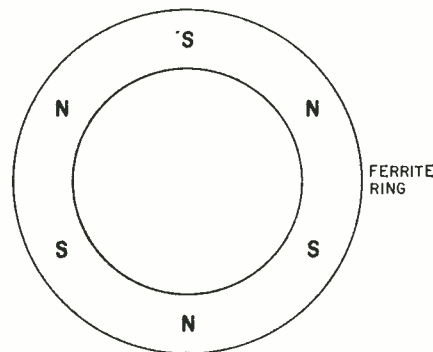

Fig. 3—Alternate poles on ferrite magnet.

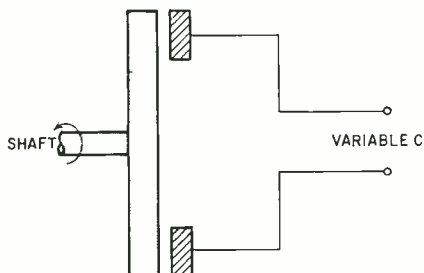

Fig. 4—Capacitance variation type of displacement detector.

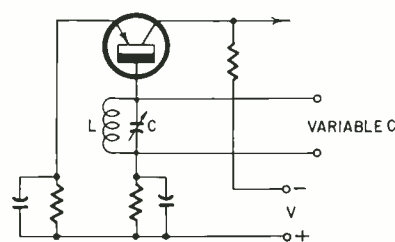

Fig. 5—Variable frequency oscillator.

duced in the windings by the rotating ferrite ring varies inversely with the air gap between ferrite and magnetic cores. Consequently, this energy is a function of the axial position of the ferrite cone, that is of the torque. In this way, the output signal of the device can be calibrated in terms of torque.

By using an extra pair of output connections and a capacitor, the frequency of the signal produced can also be measured directly, giving the rotating speed of the shaft too. Both measurements can be combined in a suitable meter to give a product reading which indicates transmitted power.

The output signal from the device may be large enough to control—without additional amplification—rugged measuring instruments or automatic regulation systems.

In another arrangement (Fig. 4), the axial displacement of a disk is transformed into a capacitance variation. This in turn can be transformed into a frequency variation with the circuit of Fig. 5. The frequency variation can then be processed by standard circuits, depending on the type of application, and used for measurement, regulation, etc. The same principle could be used with an inductance variation. Note that all the proposed arrangements give an indication which is independent of parasitic rotation effects and, in particular, of buckling.

Fig. 6 shows, in somewhat simplified form, a torque measuring instrument that uses only two European transistors. The US equivalents are:

OC76—2N188
OC72—2N188-A

One transistor is a low-frequency oscillator producing a 100-cycle signal with a base-to-emitter coupling. The output signal across the secondary winding of the transformer is applied to displacement detecting coil L, as indicated before. The variable signal, carrying the torque-variation information, is applied to the base of the second transistor, which detects and amplifies it. A meter in the collector circuit reads torque directly. END

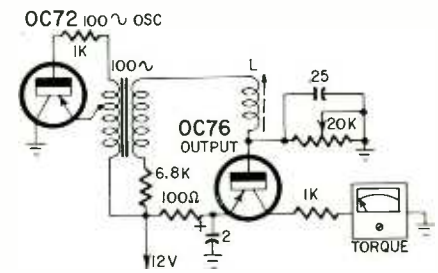
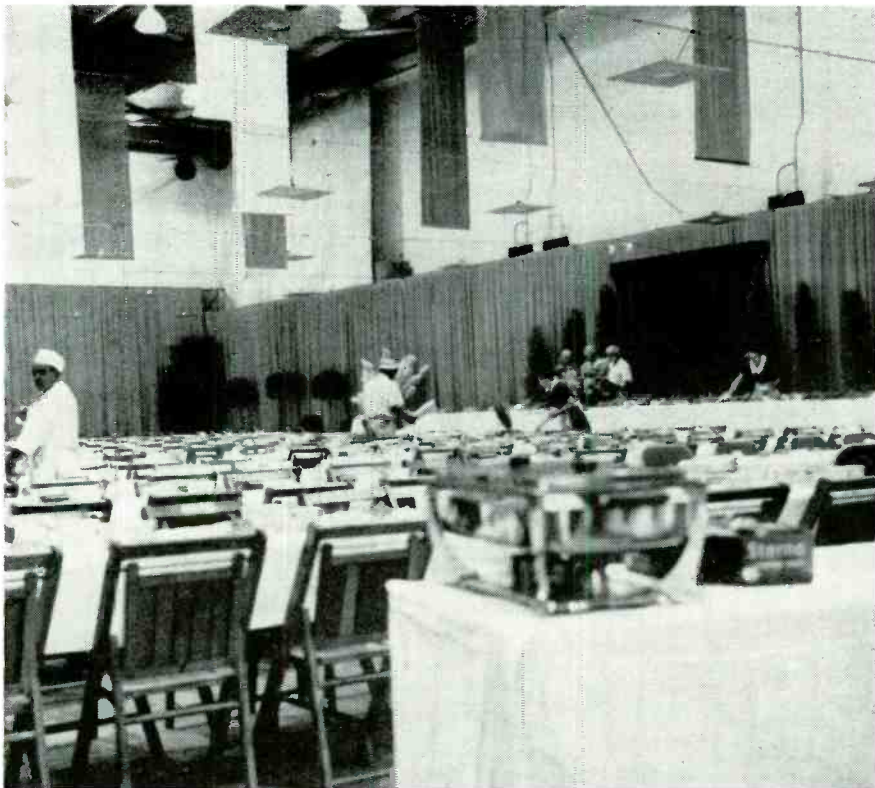

Fig. 6—Transistor torque measuring instrument.



Dedication hall setup just before meeting. Note speakers suspended from cables.

I WAS recently asked to set up a public-address system for dedication ceremonies of a large steam plant. Normally such an assignment is no problem, but as steam plants do not have large assembly halls, it was necessary to use a 60 x 120-foot room with a 40-foot ceiling and smooth concrete walls. To make matters worse, it adjoined a room in which two 180-megawatt generators were merrily running 24 hours per day. This meant installing a public-address system suitable for amplifying speeches and remarks of various dignitaries in a room

*Superintendent of Communications, Los Angeles Department of Water & Power.

where it normally was impossible to converse with a person 5 feet away.

Preliminary tests with trumpet speakers on the sides of the speaker's table proved futile. If the sound level was raised anywhere near that necessary to override the noise, reverberation effects made speech unintelligible in most of the area. Standing in front of a directional speaker and no more than 15 to 18 feet away, one could hear speech and understand, if one concentrated. At this point I decided to install 30 8-inch speakers mounted on 2 x 2-foot wood baffles above the heads of the audience.

This method of using multiple over-

*Unique speaker arrangement
beats high ambient noise*

PA Under Adverse Conditions

By MILTON I. RAVICH*

head speakers, although costly to install, is the only one I know to combat trying acoustical conditions. It has been used many times to provide excellent speech re-enforcement to an audience of 500 people in a concrete-lined room. A number of years ago I used this same method, but with 60 speakers suspended over the heads of an audience of 10,000, to provide sound re-enforcement for a stage show held directly in front of a racetrack grandstand. Most race tracks and many sporting areas have a cluster of speakers strategically located, and many observers wondered why we did not make use of the already available facilities. However, it is quite a different matter to understand the words of a slow-talking race announcer who

Speaker's view of rostrum. Microphones are arranged to be very close to speaker's lips. Note prompter unit to right of rostrum.



Temporary control room in foreman's office.



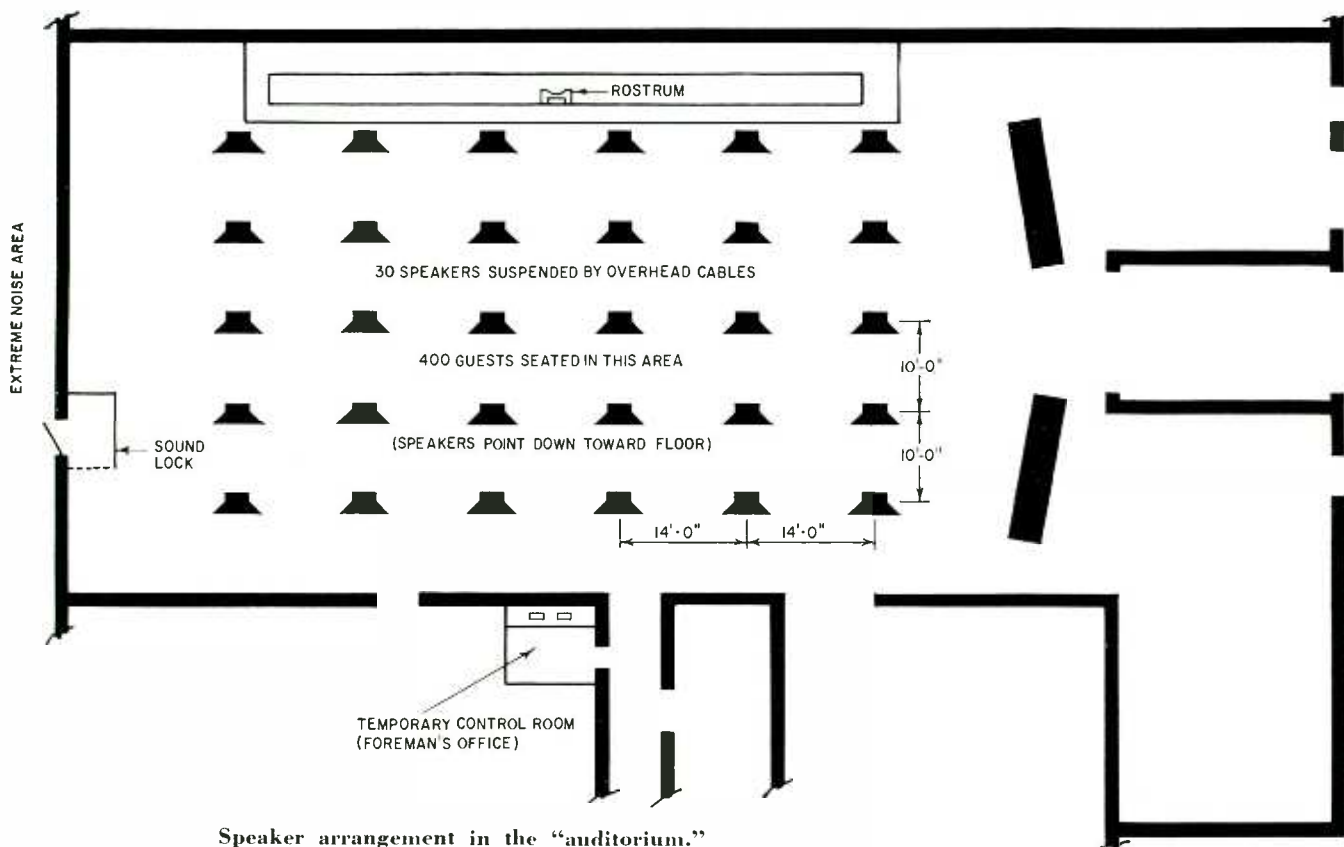

Speaker arrangement in the "auditorium."

lets each word reverberate itself out as against the rapid patter of a professional entertainer.

Speaker setup

In the steam-plant dedication job, we strung $\frac{3}{8}$ -inch steel cables under tension across the 60-foot room width. Speakers were hung in cradlelike fashion from the messenger cable. Speaker spacing is shown in the accompanying sketch. Based on an assumed ear height for the average seated guest of 4 feet from the floor, and an average speaker height of 12 feet, the closest guest would be 8 feet from a speaker. The farthest guest (seated midway between four speakers) would be 12 feet from any speaker. All 30 speakers were identical, 8-ohm, 8-inch, heavy slug construction. Speakers were phased and all connected in series to the 250-ohm output tap of a standard 20-watt amplifier.

After the speakers were installed, we worked on reducing the level of the residual noise from the generators in the next room. We got about 10 heavy painter's drop cloths measuring 12 x 15 feet and hung them strategically on walls adjacent to the generator room and high-pressure gas feed line. Next, tests were made at off peak hours with the nearest generator running at reduced load. Since the dedication ceremonies were to be held at an off-peak power time of day, it was known arrangements could be made to operate in this fashion if necessary. Reducing power to half load drastically reduced residual noise, but any further reduction in load made less than 1 db difference in the residual noise.

After taking these measures, speech

originated by talking closely into an Electro-Voice type 664 noise-cancelling microphone could be understood throughout the area, but left much to be desired. We felt that when decorative 12-foot drapes were hung on two sides of the room and an audience seated at tables the sound would be much improved. This proved to be true. It is far safer to get understandable PA without an audience than to get mediocre results and plan on the presence of people to reduce reverberation.

Final arrangements

On the day of the dedication, two microphones were set up at the speaker's table and attached to the rostrum. In the future we are planning on building our own rostrum with microphone fittings built in. Supplying furniture may seem far afield from PA work, but should it mean the speaker will be even one inch closer to the microphone, it is well worth the effort. Many would argue that better fidelity will be obtained if people speak some distance away from the microphone. All the fidelity in the world does you no good if you are working on the verge of feedback, which is exactly where you will be working when speakers are permitted to talk where and how they please.

We also built an inexpensive prompter unit consisting of three simple lamps marked:

OK
CLOSER TO MIKE
TALK LOUDER

This unit was operated by pushbuttons from an improvised control room in a foreman's office that looked out on our makeshift auditorium. Another 3-lamp

prompter was placed in front of the amplifier operator. This unit was labeled:

RAISE
OK
LOWER

An observer out on the auditorium floor operated the unit by pushbuttons.

These simple units greatly aided us in holding the actual volume of the program as heard by the audience as constant as possible. An occasional blink of the "OK" lights gave the speaker and the amplifier operator reassurance things were actually OK.

The end result was a public-address system that was clearly heard by all 400 people. The multiple speakers operated at low level (less than $\frac{1}{4}$ watt of audio ran all 30 speakers) re-enforced the voice just enough to make listeners think they were actually hearing the person at the rostrum speak directly to them. The sound seemed to come from everywhere. Standing directly under a speaker you still could not be sure which speaker you were hearing. END

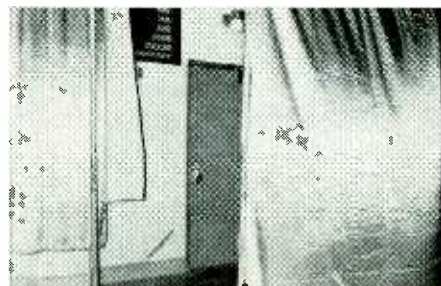

Sound lock made from canvas drop cloths traps sound when door is opened.

NEW PRODUCTS

PEN-SIZE SIGNAL TRACER locates defective circuits and components in radio and audio equipment. Detects hum, oscillations, ground loop, breaks in pc boards. All-transistor *Stethotracer* also used as preamp for oscilloscope or voltmeter. Earphone, cord, plug, 3 attenu-

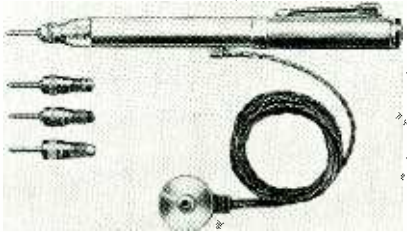

ator probes, one rf detector-demodulator crystal diode probe, ground clip lead and battery.—**Don Bosco Electronics, Inc.**, Littell Rd., Hanover, N.J.

SIGNAL GENERATOR KIT, model 280. Oscillator circuitry: preset, tuned rf coils on low bands, ceramic trimmers on high bands. Range: 170 kc to 60 mc in six bands; 60 mc to 120 mc on harmonics. Planetary drive tuning capacitor with 6:1 ratio, solid-state power supply. Output signal: unmodulated rf, modulated rf, 400 cycle af. Single output cable. Tubes: 6BE6, 12AU7. Front controls: High-low output, band selector—6 bands, output selector—"Mod-Rf-Aud".

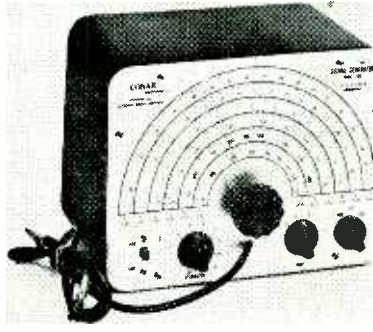

—**Conar Instruments, Div. National Radio Institute**, 3939 Wisconsin Ave., Washington 16, D.C.

POWER RESISTOR DECADE BOX, model 250. Rack-mounted, provides resistor of any re-



quired ohms 1-999,999, in 1-ohm increments. Used as standard resistance in active circuits or to determine resistances in operating circuits. Power rating 225 watts at 1,000 volts maximum. Click-in detent bar knobs, 2 sets identical terminals.—**Clarostat Mfg. Co., Inc.**, Dover, N.H.

CAPACITOR TESTER, model 995. Measures 0.1 to 50 μf at $\pm 10\%$ accuracy, in or out of circuit. RC balance control calibrated in RC product for 0.6-10.5, 7.0-infinity. RC product for out-of-circuit capacitors can be translated into dissipation or power factor. Short tests: in or out-of-circuit with shunt resistance low as 1 ohm, reliable up to 2,000 μf , test frequency 60 cycles, maximum test voltage 6.3. Open tests: 15- μf capacitors, in or out of circuit. Shunt resistance low as 35 ohms for capacitors over 250 μf , minimum 7,000 ohms for 15 μf . Test frequency 19 mc. Transformer-operated,



fuse-protected. Operates on ac line voltages 105-130, 60 cycles, 8 watts. Tube complement: one 6C4, one EM84/6FG6.—**Eico Electronic Instrument Co., Inc. (Eico)**, 33-00 Northern Blvd., Long Island City 1, N.Y.

VTVM KIT, model 202. 6-inch 400- μa meter. 11-meg input impedance, ac-dc volts to 1,500, ac peak-to-peak to 2,000 volts any waveform 30 cycles-5 mc without extra probes. Direct resistance measurements 0.2 ohm-1,000 meg, decibel scale range -10 to +15, db readings to +58 db. Zero-center scale. 12AU7 balanced push-pull dc amplifier, two 9006 peak-to-peak voltage rectifiers. 1% zero-temperature-coefficient multiplier resistors. Probes: common, acv-ohms,



MODEL 254C

GET IMPROVED AUDIO, GREATER RANGE WITH TURNER



MODEL 350C

Manufacturers know this — that's why more Turner microphones are used as original equipment on CB than any other. The Turner Model 350C for top mobile rig performance; the Model 254, ideal for base station operation. Get improved audio, greater range — get Turner, the standard microphone of the CB industry.

Model 350C (Ceramic) list price.....\$16.80
Model 254C (Ceramic) list price.....\$23.50



In Canada: Tri-Tel Associates, Ltd., 81 Shepard Ave. West, Willowdale, Ontario

THE TURNER MICROPHONE COMPANY
933 17th St. NE Cedar Rapids, Iowa

Gentlemen:
Please send me complete information and specifications on the Turner Mobile Model 350C the Turner Base Station Model 254C.

Name _____

Address _____

City _____ Zone _____ State _____



shielded dc with 1-meg isolating resistor. Selenium rectifier, transformer-operated power supply at 110-120 vac. 60 cycles, one 1.5 volt battery included.—Lafayette Radio Electronic Corp., 111 Jericho Turnpike, Syosset, N.Y.

TUBE TESTER. Tests all new 12-pin compactrons, nuvistors, Novars and 10-pin tubes, plus octal, loctal, miniature and 9-pin tubes



for shorts, leakages, intermittents and quality. Model 213, bakelite case; Model 213P (illus.), wood case. Wired or kit.—Electronic Measurements Corp., 625 Broadway, New York 12, N.Y.

LAB SCOPE KIT. Catalog no. 83 YZ 945. Steel-girder type construction modular printed circuitry. Calibrated vertical amplifiers, horizontal sweep circuits. Trigger and amplifier circuits de-coupled throughout. Dual-trace preamp. Vertical system sensitivity: 50 mv/cm—

20 v/cm. Horizontal amp response dc-2.5 mc, 3 db down, sensitivity 0.1 volt/cm-1 volt/cm. Attenuator 10:1 multiplier vernier control. Horizontal system has calibrated sweep times 0.5



sec/cm-50 nsec/cm, 30 ranges. Built-in voltage calibrator gives 1-kc square wave 10 mv-50 volts peak to peak.—Allied Radio Corp., 100 N. Western Ave., Chicago 80, Ill.

SIGNAL TRACER, model ST-22. Handles all receiver or amplifier signal levels, measures



amplifier gain stage by stage. Substitute speaker for testing receivers and amplifiers detached from own speaker systems. Output terminals for oscilloscope and vtvm. Wattmeter circuit checks power drain of equipment under test over 36-500-watt range. Noise test circuit, test amplifier (may be used as PA amplifier), two

way af-rf shielded probe with built-in selector switch.—Precision Apparatus Co., Inc., 70-31 84th St., Glendale 27, N.Y.

TV SERVICE AID, Handyman, model HM119. Combination filament checker, fuse checker, ac trouble light, TV cheater cord with on-off switch, continuity and voltage checker, dual power extension cord, pin straightener.

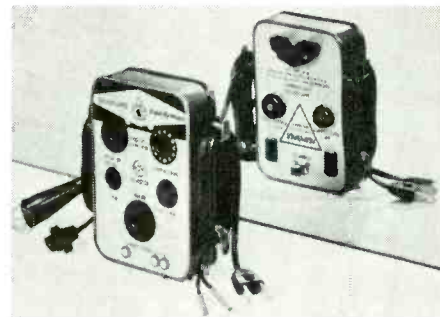

Tests all tubes including nuvistors, Novars, compactrons, 10-pins, picture tubes. Built-in plugs for soldering irons, test equipment, etc.—Sencore, Inc., 426 S. Westgate Dr., Addison, Ill.

DECADE CAPACITOR, model 1901, for determination of capacitor values in experimental



World's Finest Wire Fasteners

"HELLER GRIP" STAPLERS

heller-ply® STAPLES

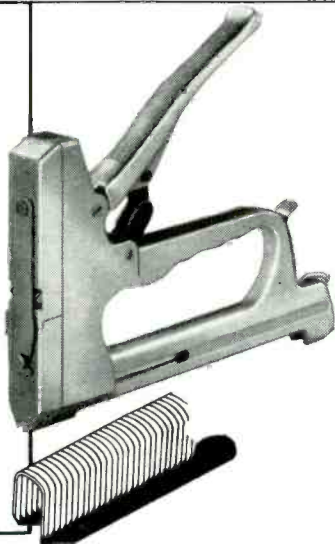

HELLER GRIP STAPLERS—Most complete line of wire stapling guns on the market! For any fastening job . . . telephone, electronic or low-voltage electrical. Securely and automatically fasten braided, jacketed or stranded wire, tubes or cables. Protect wire while they tack it. Request Catalog TKL.

heller-ply STAPLES—Rust-proof, corrosion-proof, salt-water-proof. Won't stain or run. Biggest staple advance in 25 years. Steel base, copper-electroplated for lifetime protection. Cost only half as much as staples made of Monel, stainless steel or other expensive metals. Request Catalog SPHP.

A-8531A

If it's a
HELLER
it's tops in its field

HELLER ROBERTS
Instruments Corporation
6115 Carnegie Avenue • Cleveland 1, Ohio

NEW STEREO SPEAKER SELECTOR SWITCH

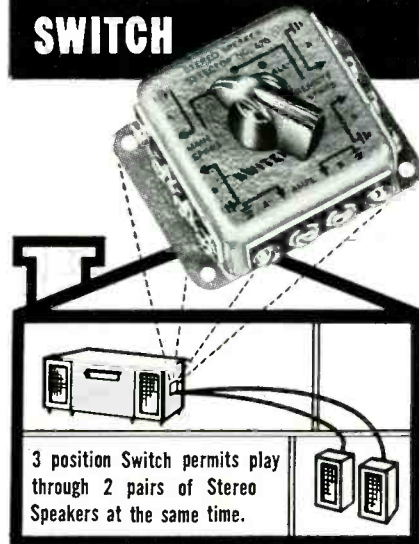

3 position Switch permits play through 2 pairs of Stereo Speakers at the same time.

Now you can listen to Stereo in any room in your home. Quality tap switch permits selection of main speakers, remote speakers or both sets at the same time.

Simple installation. Mounts on wall or cabinet. Screw terminals.

Part No. 670. U.S.A. List Price \$6.25
Contact your dealer or write for name of dealer nearest you.

SWITCHCRAFT®
INC.

5579 N. Elston Ave., Chicago 30, Ill.

RADIO-ELECTRONICS

**TRADE THE POSTAGE-PAID
REPLY CARD BELOW
FOR THESE TWO**

FREE BOOKS!

Get Your FREE COPY of this 64 Page Catalog

...telling you all about the amazing opportunities in the exploding field of electronics. Learn about the profit opportunities in the field of Radio-TV Electronics and **APPLIANCE SERVICING**. Get the facts about Central Technical Institute's NEW, down-to-earth **PRACTICAL ELECTRONICS** Home Study Course...brand new **INSTANT KITS** that can be used in starting your own business or that can be sold at a profit to friends, neighbors and customers!

Get Your FREE COPY of this 31 Page FCC Prep Book

...telling you all you need to know to pass the 3rd class FCC Radiotelephone examination. FCC 3rd class license qualifies you to operate radiotelephone transmitting stations used by airlines, police, railroads, emergency services, etc.

**EARN EXTRA MONEY SOON
IN YOUR SPARE TIME!** Train at home
for a Career in Radio-TV Electronics and
Profitable **APPLIANCE SERVICING!**

NO EXPERIENCE NEEDED!

Enroll in Central Technical Institute's New Home Study Course—**PRACTICAL ELECTRONICS**. Central will show you how to make money soon—servicing AM-FM radios, TV sets, small appliances...building and installing electronic equipment in homes, factories and business offices. The future is bright for trained technicians and servicemen. Get started today toward a prosperous business of your own or a better job...with Central's **PRACTICAL ELECTRONICS** Home Study Course. Join the thousands of Central students and graduates who are making extra money in their spare time—have their own business—or a good job with a future.

SEE OTHER SIDE!

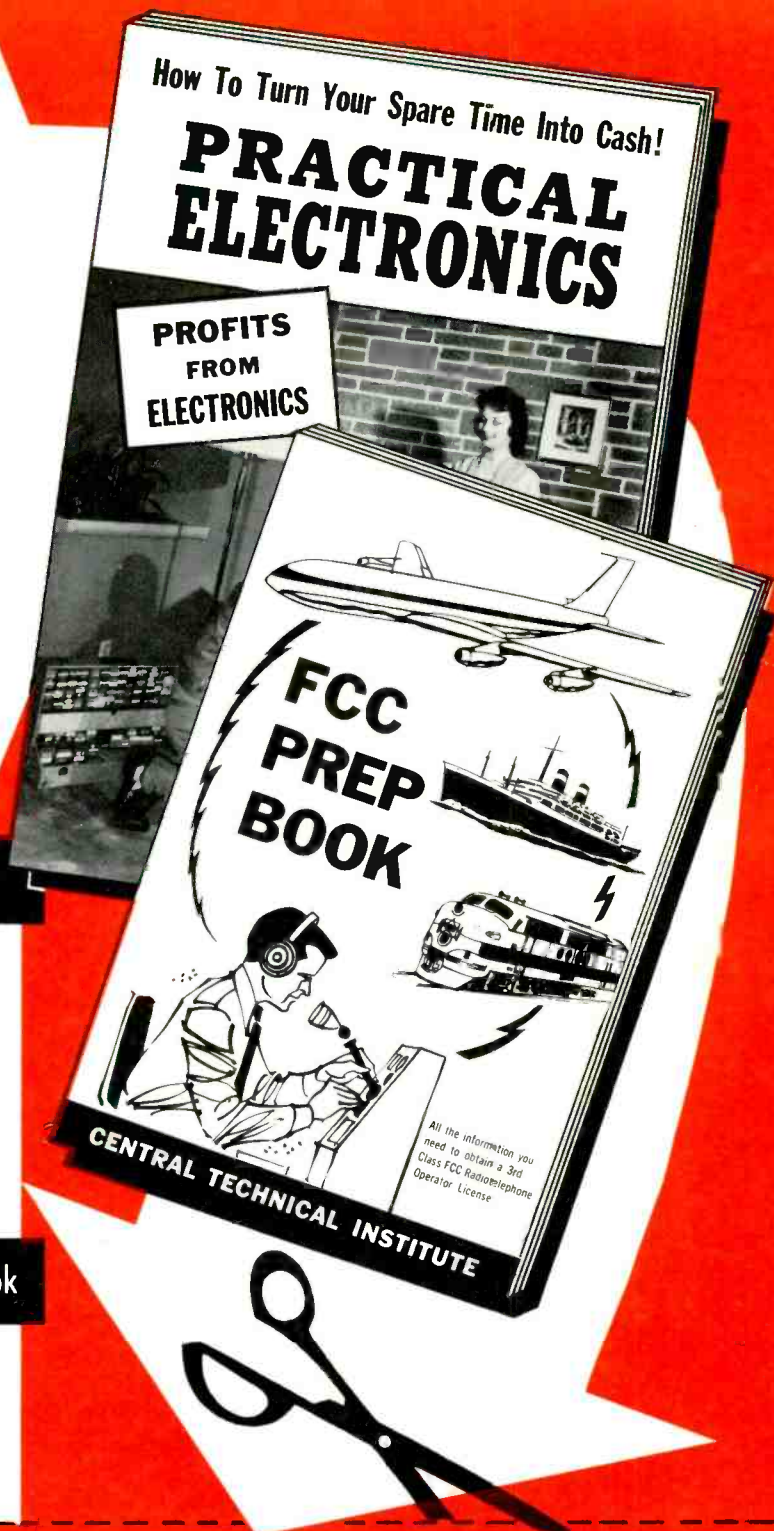

Clip and Mail This Postage-Free Card Today!

I am interested in your **PRACTICAL ELECTRONICS** home-study course. Please send copies of your 64-page catalog and **FCC PREP BOOK**, and full enrollment information.

Name _____ Age _____

Address _____

City _____ Zone _____ State _____

Phone Number _____ County _____

Check here if you want information about Central's full-time resident program in Kansas City, Missouri.

CENTRAL TECHNICAL INSTITUTE

Over 50,000 Successful Graduates since 1931!
Accredited Member National Home Study Council





NEW



CENTRAL'S INSTANT KITS®

Help you to START MAKING MONEY...SOON!

**CHOOSE THE
INSTANT KITS
THAT APPEAL
TO YOU!**

- Transistorized Electronic and Appliance Tester
- Code Oscillator
- CB Converter
- RF Signal Generator
- Photoelectric Switch
- 4 Transistor Portable Radio
- Oscilloscope

They're MODERN • PRACTICAL • COMPLETE • MEET COMMERCIAL STANDARDS

Study Practical Electronics with Central Technical Institute—Select the equipment you wish to build—start making money servicing and repairing radio-TV sets and appliances

NO EXPERIENCE NEEDED! You don't need a high school diploma or previous knowledge of electronics to get started, with Central's **PRACTICAL ELECTRONICS COURSE**. Quick, low-cost home training for young and old. New, illustrated lessons make learning easy. You learn by doing—building modern, complete, *useful* equipment furnished by Central. You earn *extra money* in your spare time doing work that is profitable and enjoyable. Keep your present job—set your own pace—add to your income—find out how much fun electronics can be!

OVER 50,000 SUCCESSFUL GRADUATES

"I wouldn't be in my present position if it weren't for my Central Technical Institute training. Naturally, I recommend the school very highly. Damon Alarm has ten employees, and four service vehicles." CLARENCE S. DAMON, President, DAMON ALARM CORP., K. C., Mo.



"I am in business for myself, operating a part-time Radio & TV Service Shop in my home. My gross part-time earnings average \$100 per month." Grad CARROLL B. SCARBOROUGH, Belton, Mo.

"The field of electronics is exciting. There are opportunities galore. I received training at Central Technical Institute and I recommend the school without qualification." FRANK LEENKNECHT, CONVAIR ASTRONAUTICS DIVISION, GENERAL DYNAMICS CORP.



RESIDENT TRAINING—Central also offers a full-time ECPD-Accredited Technical Institute program at its resident school in Kansas City, Mo., for qualified high school graduates. Details in FREE catalog.

ACT NOW! RECEIVE 2 FREE BOOKS!

FILL OUT REVERSE SIDE AND MAIL TODAY!

**IF CARD IS MISSING, WRITE TO:
CENTRAL TECHNICAL INSTITUTE**

1644 WYANDOTTE, KANSAS CITY 8, MO.

FIRST CLASS
Permit No. 3021
Kansas City, Mo.

BUSINESS REPLY MAIL

NO POSTAGE STAMP NECESSARY

IF MAILED IN THE UNITED STATES

POSTAGE WILL BE PAID BY—

CENTRAL TECHNICAL INSTITUTE

1644 Wyandotte Street
Kansas City 8, Missouri

DEPT. 03042

circuitry and use in tuned circuits, filters, etc. Range .0001 to .111 μ f in steps of .0001 mf \pm 1% accuracy. All capacitors silvered mica, resistance more than 100,000 meg at 500 volts dc. Voltage rating of overall unit 350 dc, 500 intermittent, 1,000 test. Capacitor power factor .001%.—Precision Apparatus Co., Inc., 70-31 84th St., Glendale 27, N. Y.

BATTERY ELIMINATOR/CHARGER, model P-23, for 6-12 volt apparatus. Panel-mounted extractor fuse post, built-in thermo-relay, 2 meters for simultaneously monitoring voltage



and current. Output current capacity, 6-volt range: 10 amps dc continuous, 20 amps dc intermittent 12-volt range: 6 amps dc continuous, 12 amps dc intermittent. Special low-ripple output capacity 5 amps dc continuous, both ranges. Variable output 0-8 volts, 0-16 volts dc. Power requirements: 117 volts 50-60 cycles, 150 watts full load.—Precision Apparatus Co., Inc., 70-31 84th St., Glendale 27, N.Y.

FM STEREO TUNER, model 101GTM. Needs no adapter. Subchassis construction, 3-gang tuning unit, cascade rf, triode mixer, 2 wideband i.f., 2 limiter stages, ratio detector,

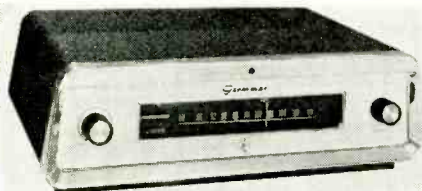

flywheel tuning and Magic Bar tuning indicator. Silicon power supply.—Grommes, Div. of Precision Electronics, 9101 King St., Franklin Park, Ill.

STEREO TAPE RECORDER, model MP-410-A. 2-track stereo, 4-track monaural record and playback. 2 tape heads, 2 preamps, 2 power amps, 2 built-in stereo speakers with separate



volume controls, recording-level indicator for each channel, splicing groove, headphone plug. Outlets for external amplifiers, speaker. Inputs for all sound sources. One interlocking switch plays all speeds.—AmeLux Electronics Corp., 60 E. 42 St., New York, N.Y.

STEREO FM TUNER/AMP, model STA-7. Direct reception of stereo FM multiplex from FM stations. 24-watt stereo amplifier. 14 tubes in tuner section, sensitivity 2.5 μ v, 30-db quieting. On-off afc, grounded-grid rf stage,



ratio detector, third-channel output, full range of controls. Amplifier section response 20-20,000 cycles \pm 1 db, may be used as stereo or mono amplifier by using built-in input jacks. Output terminals for 4-, 8- and 16-ohm speakers, out-

put jack for stereo headphones.—Radio Shack Corp., 730 Commonwealth Ave., Boston 17, Mass.

AUDIO EQUALIZER, model 323A. For mono or stereo ceramic phono cartridges. Plugs into magnetic input of amplifier without modifi-

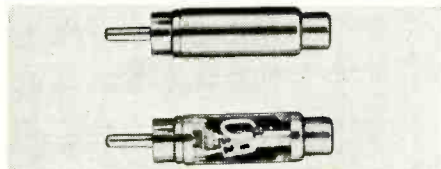

cation. Converts to velocity response for RIAA equalization.—Switchcraft, Inc., 5555 N. Elston Ave., Chicago 30, Ill.

10 1/2-INCH REEL ADAPTER. 12 hours hi-fi, 3 hours stereo record and playback. Fits manufacturer's model 990 stereo tape recorder,

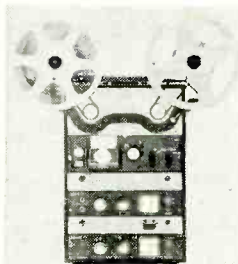

199D tape deck and 191 and 192 tape recorders. Wow and flutter 0.5% maximum.—Roberts Electronics, Inc., 5920 Bowercroft St., Los Angeles 16, Calif.

MIXER-PREAMP, model DPR-7. Applies dc on all tube filaments. 5 low-level high-gain inputs, two high-level. Channel 1: mike or magnetic cartridge input. Channels 2, 3: mike or



input from tuner or tape recorder, crystal or ceramic phono player, all controlled from front panel. Channel 4: mike input, convertible to master volume control for entire mixer.—Harman-Kardon, Inc., Ames Court, Plainview, N.Y.

RADIO, TAPE RECORDER, model 400. Portable, under 10 lb. Four 1.5 volt flashlight batteries, external ac. 1 1/2 and 3 3/4 speeds, 3 hours recording time. 12 transistors, diodes and rectifier. Record-playback, erase head, arbitrary



counter, dual meter, 5-inch reels.—American Concertone, Inc., Div. Astro-Science Corp., 9449 W. Jefferson Blvd., Culver City, Calif.

PORTABLE TAPE RECORDER, The Statesman. Dual-track, 2 speeds, plays 3-, 5-, 7-



inch reels. Hand-held wide-range mike. *Miss Webcor*, portable stereo phonograph. 2 wide-range speakers in separate sound chambers swing away from case. 4-speed changer with automatic shutoff intermixes 7- and 12-inch 33-rpm records. Stereo cartridge with 2 separate jeweled styli, will play 78 rpm.—Webcor, Inc., 5610 W. Bloomingdale Ave., Chicago, Ill.

MULTIPLEX ADAPTER, model MPX-20a. Companion to model MPX-100, for concealed installation. Self-powered, can be placed 3 feet from tuner or receiver. 2 controls match output level of adapter to other program sources. Selector switch for monophonic recording of stereo programs. Matched to tuner or receiver at time

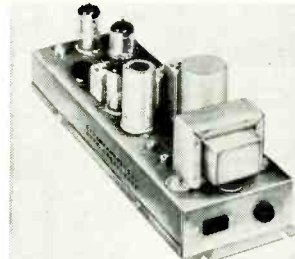

of installation. 15-ke steep rolloff, low-pass filter.—Fisher Radio Corp., 21-21 44th Drive, Long Island City 1, N. Y.

TEACHER'S AID PHONO/SOUND SYSTEM, model VP-10. 4 speeds, variable-speed adjustment, 10-watt amplifier, 12-inch speaker with ceramic magnet, 25-foot interconnecting cable. Variable speed control, automatic motor



start. Plays all records up to 12-inch size, each speed adjustable over \pm 5% range. Separate bass and treble controls, inputs for speaker and mike jacks.—Bogen-Preston Div., Siegler Corp., PO Box 500, Paramus, N.J.

ELECTRONIC MEGAPHONE. Battery-operated, 8-10 hours continuous operation. Power source: 6 volts (4 flashlight D-cells). Range to



1,200 feet.—Fedro, Inc., Federal Electronics Sales Div., Federal Electronics Bldg., Rockville Centre, N.Y.

2-STATION INTERCOM KIT, model KT-196. 3-tube circuit, 2 stages audio amplification. 3-way lever switch on master station, combined on-off volume control on front panel. Remote unit with talk-listen slide switch may be left

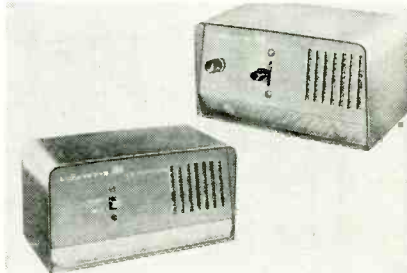

only in "talk" position, requires no power. Instruction manual, 50 feet of 3-wire cable. Factory-wired Model LA-196.—Lafayette Radio Electronics Corp., 111 Jericho Turnpike, Syosset, N.Y.

AUTOMATIC TAPE CARTRIDGE. Model 300—300 ft, model 600—600 ft, model 1200—1200

NEW SAMS BOOKS

BRAND-NEW! 4th Edition of
the Famous Howard W. Sams



Tube Substitution Handbook

Still Only \$1.50

- ★ Includes Over 1400 New Substitutions
- ★ Brand-New Section on Subminiature Tubes



This newest edition is more valuable than ever! Now lists more than 6,600 DIRECT substitutes (1400 more than in prior volume), including new section showing substitutes for over 250 subminiature types. 3050 substitutes for 1758 receiving tube types. 242 industrial and 622 European substitutes for American receiving types; 530 American substitutes for European types. Picture-tube substitutions now include 43 new types (508 total) and over 1900 DIRECT substitutions. A "must" for every tube caddy and service bench. 112 pages; 5 1/2 x 8 1/2". Still only..... \$1.50



Transistor Radio Servicing Made Easy

Wayne Lemons has written the first completely practical book on the subject—based on nearly a year of his own experience in perfecting a technique to insure profitable repairs. You get the benefit of his experience—no "hole and electron" theory—but solid, practical circuit explanations and servicing procedures that will help you repair almost any transistor radio in minutes. The final chapter alone, on parts procurement and substitution, is well worth the book cost. 128 p.; 5 1/2 x 8 1/2". Only..... \$1.95

FM Multiplexing for Stereo

The most up-to-date volume on this brand-new broadcasting technique. Leonard Feldman expertly describes the new receiver and adapter designs, as well as the problems of converting existing sets and developing new servicing and alignment methods. 8 fact-packed chapters cover the FCC-approved system, converting present sets, servicing multiplex circuits, adapter alignment, typical circuits, etc. 128 pages; 5 1/2 x 8 1/2". Only..... \$2.50

Basic Electronics Series: Transistor Circuits

Capt. T. M. Adams completely explains basic transistor circuits. As in his previous 3 volumes, 4-COLOR circuit diagrams show you exactly what actions take place during every moment of operation. Each and every electron current is unmistakably identified, as are the changes each undergoes in actual operation. Covers: Transistor Physics Simplified; Special Techniques & Definitions; Oscillator Circuits; Amplifier Circuits; Detector Circuits. 128 p.; 5 1/2 x 8 1/2". Only..... \$2.95

Single-Sideband Communications Handbook

Only book of its kind. Harry D. Hooton presents much previously unavailable data on this important subject—invaluable to anyone in communications, including engineers, hams, and technicians. Describes single-sideband development, carrier suppression, carrier generators, speech amplifiers and filters, balanced mixers and converters, linear power amplifiers, SSB receivers, tests, measurements, etc. 320 p.; hardbound; 5 1/2 x 8 1/2". Only..... \$6.95

HOWARD W. SAMS & CO., INC.

Order from your Sams Distributor today, or mail to Howard W. Sams & Co., Inc., Dept. D-22 1720 E. 38th St., Indianapolis 6, Ind.

Send me the following books:

- Tube Substitution Handbook, Vol. 4 (TUB-4)
- Transistor Radio Servicing Made Easy (TRE-1)
- FM Multiplexing for Stereo (FMS-1)
- Basic Electronics Series: Transistor Cir. (BET-1)
- Single-Sideband Communications (SH-1)

\$..... enclosed. Send Free Book List

Name.....

Address.....

City..... Zone..... State.....

IN CANADA: A. C. Simmonds & Sons, Ltd., Toronto 7 (outside U.S.A. priced slightly higher)



ft. Continuous, self-contained single-reel tape magazine, automatic rewind.—Conley Electronics Corp., 1527 Lyons St., Evanston, Ill.

RECORD PLAYER/EARPHONE COMBO, Personal Listener, eliminates need for loud-speaker in classrooms. 4-speed player, diamond-sapphire turnover cartridge, four-pole motor



and separate volume controls.—Koss, Inc., 2227 No. 31st St., Milwaukee, Wis.

RADIOTELEPHONES, Model TR505 (illus.), self-contained for base-station or dash-mounted mobile use in 450-470-mc band. Model TR506 Control Head. Combined speaker, dash-mounted. Functions through trunk-mounted

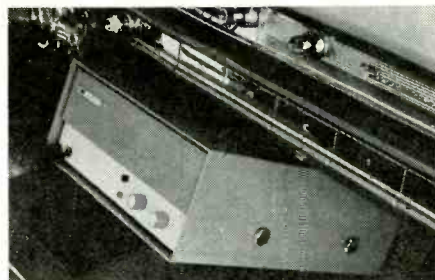

transmitter-receiver. Model TA508 rf amplifier, 30 watts for base-station or repeater use. Power supplies transistorized or 117 volts ac.—Kaar Engineering Corp., 2995 Middlefield Rd., Palo Alto, Calif.

SINGLE-SIDEBAND TRANSMITTER, kit model HX-10. Built-in power supply, crystals for 80-10 meters. CW, AM, FSK, SSB emission. Power input: 180-watt CW, 180-Watt PEP SSB, 75-watt AM. Power output: 100 watts nominal into 50 ohms, CW and SSB, 25 watts AM. Out-



put impedance: 50-75 ohms. Frequency range: 3.5-, 7-, 14-, 21- and 28-mc bands. Carrier suppression 50 db below peak output. Af response: 400-3,000 cycles at ±3 db. Control voltage applied to i.f. amplifier stage.—Heath Co., Benton Harbor, Mich.

HAM-BAND RECEIVER KIT, model HR-10. 80-10 meters, tunes SSB, AM and CW signals. Prebuilt, preset coil-bandswitch assembly. Transformer power supply. Separately calibrated bands



NEXT MONTH

You'll find these exciting features in

Radio-Electronics

Latest FM stereo multiplex schematics

Have you found that the adapters you're asked to service differ from the schematics published a few months ago? And doesn't it seem that every adapter uses a different circuit to do the same thing? Circuits have been modified—and they do differ. This feature gives you the latest diagrams, explains how they work and why they differ from others.

Construct your own low-cost TV camera

Here's a good practical unit—at just a fraction of what a commercial job would cost. Think what you could do with it—baby-sitting, store watching, sales promotion, even amateur TV on the air. The possibilities are endless—and challenging. Works with any TV receiver.

Should I build a kit or build from scratch?

Good question! How many times have you faced it? Depends on what you're looking for, says the author. You'll relish his own answer to the problem.

Industrial technician's pocket service kit

The equipment a practical industrial technician uses in his own factory electronics work.

Plus many other high-power articles on TV, radio, servicing, hi-fi, construction, electronics—and all the welcome regular departments.

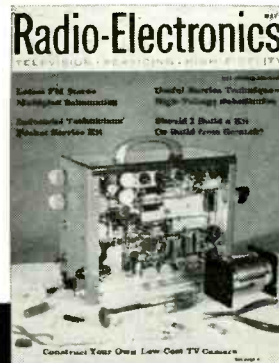

MAY ISSUE
ON SALE APRIL 19

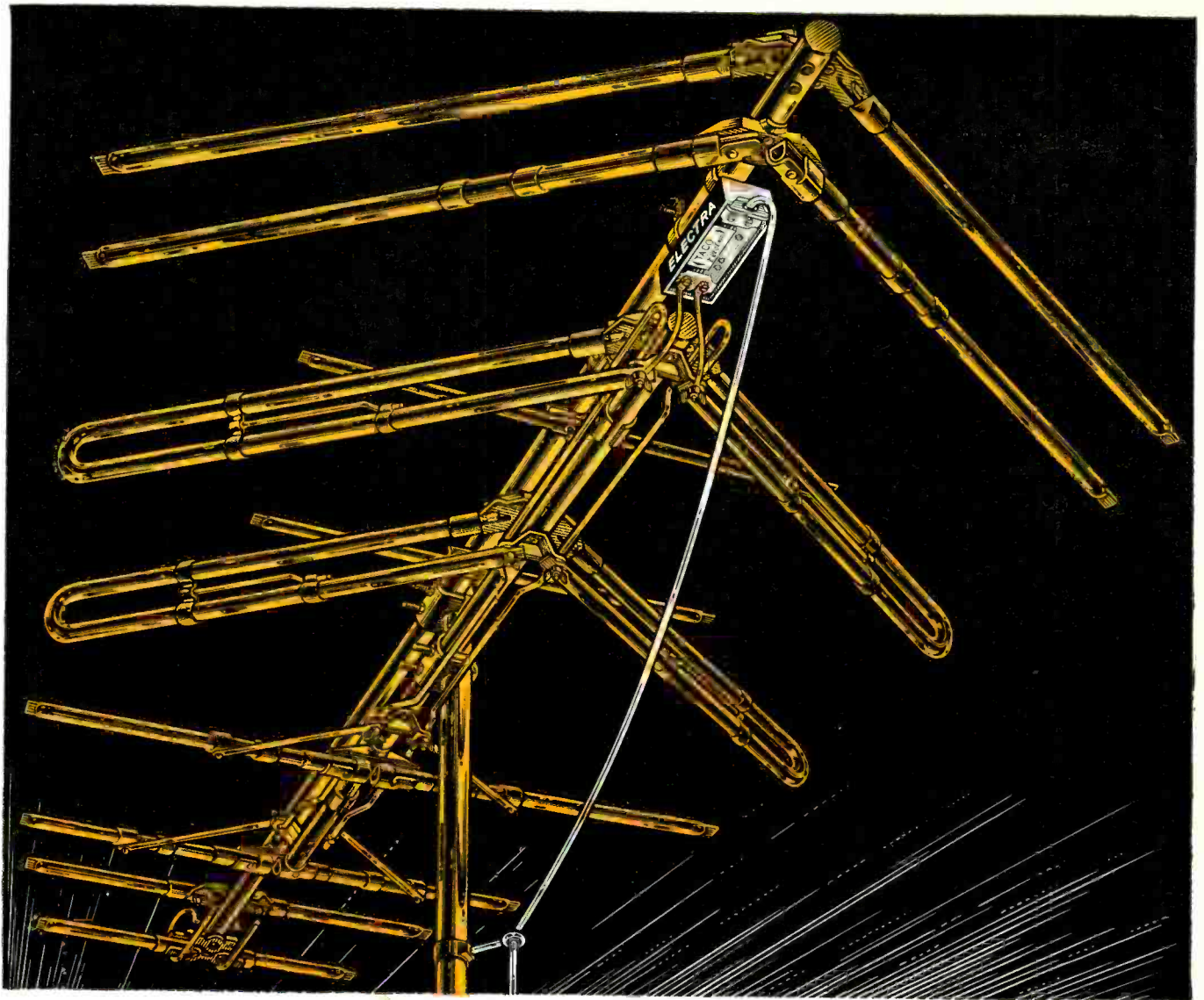

HOTTEST

Servicemen and distributors everywhere are talking about the hottest-performing electronic antenna around—the TACO T-BIRD ELECTRA.

And you know what started them talking... color TV. Color reception is the ultimate test of an antenna today, and here the T-BIRD ELECTRA's superior design separates the men from the boys. No friction noise, no signal flutter, a rifle-sharp forward lobe, flat response on all channels—and the best transistor preamplifier in the business (Jerrold-designed)... a few of the reasons why T-BIRD ELECTRAS (model for model) are *the world's most powerful electronic antennas*. Every element is extra rugged and put there to *work*, not just look pretty.

Only TACO, of all leading TV antenna manufacturers, has deep experience in designing satellite-tracking and defense antennas, as well as the best electronic know-how in the business. It's this combination that's making T-BIRD ELECTRA the hottest antenna news today. Add to this the new promotional concept that TACO offers you, and you have a line that can't be beat. Hot tip: GO TACO.

Shown above: T-BIRD ELECTRA Model G-990-8, list price \$107.20. Other T-BIRD ELECTRAS as low as \$78.80. Unpowered T-BIRD antennas list from \$28.30 to \$65.05.



TACO T-BIRD ELECTRA

WORLD'S MOST POWERFUL ELECTRONIC TV/FM ANTENNA

TECHNICAL APPLIANCE CORPORATION, Dept. JTD-26, Sherburne, N.Y.

A Subsidiary of Jerrold Electronics Corporation

In Canada: Jerrold Electronics (Canada) Ltd., 50 Wingold Ave., Toronto • Export: Joseph Plasencia, Inc., 401 Broadway, New York 13, N.Y.

Now! A new, all-in-one, Multiplex Generator with built-in FM signal generator—

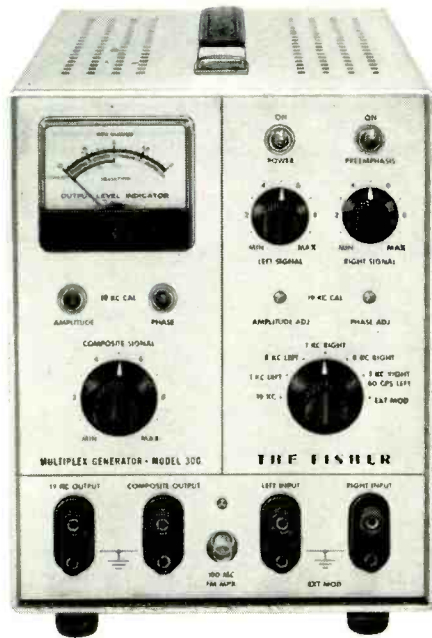

and it's by Fisher!

Only Fisher Could Have Designed the New Model 300 Portable Multiplex Generator —because only Fisher has the engineering depth in FM Stereo tuners and receivers to create the ideal test equipment for servicing them. The future of high-fidelity radio unquestionably belongs to FM Stereo Multiplex and the Model 300 is the instrument for the service technician in search of new business. It is compact, fully portable and completely self-contained. It has its own built-in FM signal generator. In addition to a composite MPX signal, it also generates low-distortion, stable audio signals. Thus it requires no companion instrument for full alignment of Multiplex equipment. Best of all, it costs only \$495.00. **FISHER**

Save \$100! Act now!
If—and only if—you mail this coupon immediately, you will receive a \$100.00 credit certificate toward the purchase of a Fisher Model 300. This is strictly a pre-production offer—pay only \$395—so act now!

Fisher Radio Corporation
21-51 44th Drive, Long Island City 1, N. Y.

Please send Multiplex Generator Credit Certificate.

Name.....
Address.....
City.....Zone.....State.....NY 110

on slide-rule dial. 7-tube superhet circuit with rf stage and half-lattice crystal filter. Panel S-meter, front-panel dial calibration control, 8-ohm speaker jack and accessory socket.—Heath Co., Benton Harbor, Mich.

ALL-TRANSISTOR RADIO KIT, DX'er. 3-oz penlight batteries, receives AM band 550-1500 kc, short-wave signals 7.5-17.5 mc. Conelrad frequencies marked on AM scale, second

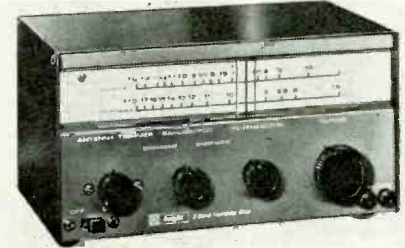

scale for tuning international SW and amateur broadcasts on 20-meter band.—Allied Radio Corp., 100 N. Western Ave., Chicago 80, Ill.

POCKET TALKIE, model 400. Hand-held 1½-watt 2-way radio. 5-mile range. Noise limit-



ing, variable squelch, above ½-watt audio power. 15 transistors, 1 diode. Penlight or nickel cadmium 500-ma-per-hour rechargeable batteries.—Ross Laboratories, Inc., 124 Lakeside Ave., Seattle 22, Wash.

TONE-CALL SYSTEM, model F-82, for two-way equipment. Eliminates co-channel interference, permits base-station operator to blow horn on mobile radio. Call-in indicator at base station shows which unit is calling. Multi-tone audio signals actuate 5-channel resonant-reed



relays. Thyatron neon lamps in call-in circuits, all tone-sending circuits transistorized. 4 circuit taps required at base station, mobile units require speaker tap plus swap in microphone plugs. Factory pretuned.—Allison Electronics, Inc., 2545 Diversified Way, Orlando, Fla.

PRINTED-CIRCUIT CAPACITOR, radial or axial leads, flush mounting. Radiation and shock-resistant, no damage under temperature

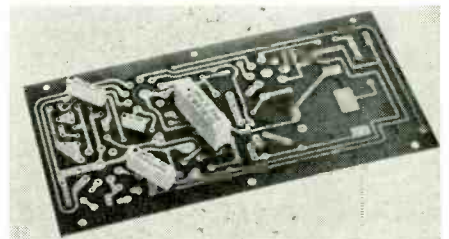

variations —55° to +125°C.—Victoreen Instruments Co., 3580 N. Elston Ave., Chicago 18, Ill.

TRANSISTOR TRANSFORMERS for constructing transistorized 20 watt stereo amplifier Motorola kits SK-104, -105. Model TA-61 driver: Turns ratio, primary to ½ secondary, of 1:1; dc resistance 1.8 ohms per winding. Model TA-62 (illus.) output transformer: 25-ohm primary impedance, 4-ohm secondary. Dc resistance: 1.5 ohms primary, 0.4 ohm secondary. Maximum primary dc 400 ma. Model P-8196 capacitor in-

Wanna' Sell? ... Buy? ... Trade?



For best results use
Radio-Electronics

Rates as low as \$5.
50¢ a word—10 word minimum

Radio-Electronics 154 West 14th Street • New York 11, N. Y.

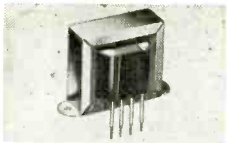

put filter power transformer: Delivers 45 volts dc. Primary impedance 117 volts, 50/60 cycles ac, secondary 80 volts ac, center-tapped. Secondary current 1.2 amps dc.—Stancor Electronics, Inc., 3501 Addison St., Chicago 18, Ill.

ANTENNA BOOSTER, model MA-800, fits any antenna. Rated gain to 19 db, TV-FM. 3-way mount for antenna, wall or mast. Shock-proof ac power supply has local-distance and

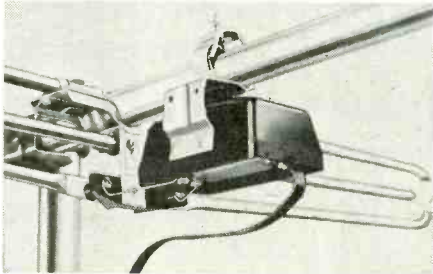

polarity switch, ac outlet and built-in two-set coupler. Input high-pass filter rejects interference from CB and amateur stations, garage-door operators and other sources.—Winegard Co., 3000 Scotten Blvd., Burlington, Iowa.

BEAM ANTENNA, model J. Modular construction, infinite-impedance feed design. Matched sections can be added to basic 4 over 4 antenna

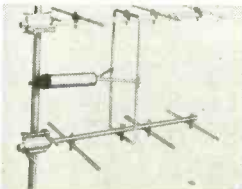

for increased gain. Heavy-walled aluminum tubing, clamps and fittings forged with rust/corrosion-proof metal alloy. Models for all amateur bands and commercial frequencies.—Gain, Inc., 1209 W. 74th St., Chicago 36, Ill.

TERMINAL WRENCH for servicing foreign-made transistor radios. Releases spanner nut on external antenna and earphone jacks of many imports. Model TW32—with .086" guide

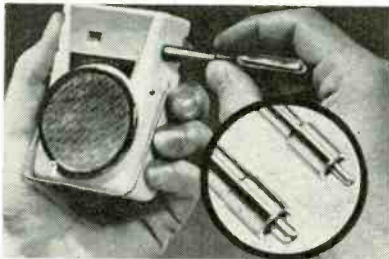

pin, for 1/4" OD spanner nut; model TW140—with .140" guide pin for 5/16" OD spanner nut.—Xcelite, Inc., Orchard Park, N.Y.

All specifications from manufacturers' data

NEW LITERATURE

CATALOGS • BOOKLETS • CHARTS

TRANSISTOR REPLACEMENT CHART lists commonly used types for TV, radio, hi-fi, auto and home equipment. Indicates manufacturer's number, type, p-n-p or n-p-n, and replacement. Includes base diagrams of five transistor types, giving locations of leads, plus

section on American-made replacements for foreign-made units.—Semitronics Corp., 370 Broadway, New York, N. Y.

ELECTROLYTIC CAPACITOR REPLACEMENTS—2,450 of them—listed in 36-page *Manual K-105*. Includes 221 TV and radio manufacturers, gives original part numbers, ratings, recommended replacements and list prices. Mailing charge 10¢.—Sprague Products Co., 81 Marshall St., North Adams, Mass.

HI-FI AND STEREO EXPLAINED in 20-page illustrated booklet *Guide to Custom Stereo*. Outlines use of various components, explains FM stereo, gives meaning of technical specs and shows manufacturer's newest components.—H. H. Scott, Inc., Dept. P, 111 Powdermill Rd., Maynard, Mass.

AUDIO EQUIPMENT offered in 372-page 1962 catalog includes industrial and OEM components, professional audio and recording equipment, and hi-fi, stereo and CB supplies.—Harvey Radio Co., Inc., 103 W. 43 St., New York 36, N. Y.

SILICON ALLOY JUNCTION DIODES, *Bulletin SS-200*. Fold-up chart lists general-purpose and computer diodes, high and low current. Diagrams illustrate special-performance characteristics. — Sperry Semiconductor, Div. Sperry Rand Corp., Norwalk, Conn.

SILICON POWER TRANSISTORS detailed in 12-page *Bulletin 54-662*. Charts and graphs illustrate electrical characteristics, test circuits and peak pulse power capabilities of 30-amp types. — Westinghouse Semiconductor Dept., Youngwood, Pa.

AUDIO, VISUAL SIGNAL SYSTEMS AND PARTS for hotels, motels and institutions. Approximately 130 items, including paging center, alert system, loudspeakers and accessories, PA equipment, etc. Many photos.—American Communications Corp., 280 Broadway, New York 7, N. Y.

60-CYCLE TRANSISTOR POWER TRANSFORMERS specified in 1-page leaflet. 70 models, in 7 sizes with 10 secondary voltages, shown on charts with full specs.—Magnetic Circuit Elements, Inc., 3722 Park Place, Montrose, Calif.

CONTACT RELAYS described in 10-page *Catalog 100* includes 40 standard types with 500 variations, plus new series of mercury-wetted-contact relays. Specs and prices given on all items.—Potter & Brumfield, Technical Information Section, Princeton, Ind.

BUILT-IN STEREO HI-FI MUSIC SYSTEM, liberally illustrated 15-page building guide for do-it-yourselfers, explains key points in building a home entertainment wall. Section on component placement emphasizes space requirements, ventilation, accessibility and wiring needs. Detailed instructions for installation and wiring of speaker systems, plus suggested decorative schemes. Complete with 20 x 32-inch building plans.—Allied Radio Corp., 100 N. Western Ave., Chicago 80, Ill.

MICROWAVE OPTICS DEMONSTRATION APPARATUS fully described in 24-page illustrated *Booklet No. 306*.—Central Scientific Co., Cenco Instruments Corp., 1700 W. Irving Park Rd., Chicago 13, Ill.

CB TRANSMITTER, model no. 23/S-Nine described in 4-page brochure with photo and specs.—Browning Labs, Inc., 100 Union Ave., Laconia, N. H.

POWER RESISTOR DECADES described in 4-page leaflet *Dial and read 1 to 999,999 ohms*. Gives data on rack version plus standard bench unit. Provides theory, circuit diagrams, application and operation data, parts and specs.—Clarostat Mfg. Co., Inc., Dover, N. H.

ELECTRICAL WIRE TACKERS, 5 models, presented in 4-page *Catalog TKL* with photos, specs and application data on full Heller-Grip line.—Heller Roberts Instruments Corp., 6115 Carnegie Ave., Cleveland 3, Ohio. END

Any or all of these catalogs, bulletins, or periodicals are available to you on request direct to the manufacturers, whose addresses are listed at the end of each item. Use your letterhead—do not use postcards. To facilitate identification, mention the issue and page of RADIO-ELECTRONICS on which the item appears. UNLESS OTHERWISE STATED, ALL ITEMS ARE GRATIS. ALL LITERATURE OFFERS ARE VOID AFTER SIX MONTHS.

TRAIN WITH THE LEADER FOR YOUR FCC LICENSE



Mail coupon for fast facts about NRI's up-to-date home study training that prepares you for your FCC exams. Earn your "ticket" to better paying jobs and fast growing opportunities. Train with NRI—the oldest and largest school of its kind.

MAIL NOW

National Radio Institute
Washington 16, D. C. BDF

Send me information on NRI's special FCC License training. (No representative will call. PLEASE PRINT)

Name _____ Age _____

Address _____

City _____ Zone _____ State _____

Accredited Member
National Home Study Council

HOTTEST VALUE IN AMERICA TEST EQUIPMENT

COMPLETE INSTRUMENTS (Not Kits) Wired, Calibrated & Ready-For-Use

ACCURATE MODEL #152

SENIOR V.T.V.M. TUBE TESTER



FEATURES GIANT 6 1/2" METER

- D.C. VOLTMETER—Ranges: 0 to 3, 30, 150, 300, 1500 Volts.
- ZERO CENTER VOLTMETER (for discriminator alignment). Ranges: 0 to 1.5, 15, 75, 150, 750 volts.
- A.C. VOLTMETER—R.M.S. Ranges: 0 to 3, 30, 150, 300, 1500 volts.
- PEAK TO PEAK RANGES: 0 to 8, 80, 400, 800 volts.
- OHMMETER: Ranges: 0 to 1000 megohms (5 overlapping ranges).
- DECIBEL METER (for all audio measurements) Ranges: -10 to +5, +6 to +25, +26 to +45 decibels.
- CENTER SCALE 10, 100, 1K, 100K, 10 Megohms

Complete with Test Leads Probe and Instructions. ^{\$49.00} Value Only... **\$29.95**

ACCURATE MODEL #151

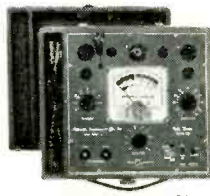

TESTS OVER 1,000 TUBE TYPES

- Checks all tubes including 7-pin miniatures; octals, lock-in's; 9-pin noval miniatures & new T-9 types.
- Makes all necessary tests. Checks for shorts and leakages between all elements. Indicates emission of all tubes.
- 5 Year Free Tube Data
- Rugged accurate, highly damped meter movement with sealed air-damping chamber.

Model #151 comes complete including instructions. ^{\$39.00} Value Only... **\$21.95**

TV PICTURE TUBE TESTER #151A Operates through #151 Tube Tester. ^{\$3.00} Value Only... **\$3.85**

ACCURATE MODEL #153

SIGNAL GENERATOR AND SIGNAL TRACER



EACH UNIT FUNCTIONS INDEPENDENTLY OR IN CONJUNCTION

- SIGNAL TRACER—
- Hi-gain cascode pre-amplifier.
 - Pre-amplifier output available at front panel jacks for use with VTVM, oscilloscope or phones.
 - Low distort triode output stage.
 - Audio Attenuator provided to prevent high signal overloading.
 - 4 1/2" P.M. speaker.
 - Separate R.F. and Audio signal tracing probes.

Model 153 comes complete with all necessary probes. ^{\$49.00} Value Only... **\$28.40**

SIGNAL GENERATOR

- Covers from 250 KC to 120 MC in 5 bands.
- Popular frequencies marked on panel in color.
- High stability electron coupled R.F. Oscillator.
- Attenuator used on both R.F. and Audio Circuits.

Model 153 comes complete with all necessary probes. ^{\$49.00} Value Only... **\$28.40**

"ONE DOLLAR" buys

As much as \$15 worth - Everything Brand New and sold to you with a money back guarantee.

10% OFF & FREE GIFT ON PURCHASE OF \$10.00 OVER (ON DOLLAR BUYS)

- | | | | |
|--|---|--|--|
| <input type="checkbox"/> 1-6" x 9" OVAL PM SPEAKER (one to a customer) \$1 | <input type="checkbox"/> 300 - ASST 1/2 W RESISTORS \$1
AB, IRC. Short leads, excellent. | <input type="checkbox"/> 30 - ASST. PILOT LIGHTS \$1
#44, 46, 47, 51, etc. | <input type="checkbox"/> 5-9 V RADIO BATTERIES \$1
similar to Eveready #216 |
| <input type="checkbox"/> 4-456KC I.F. TRANSFORMERS assorted types and sizes \$1 | <input type="checkbox"/> 200 - CERAMIC CONDENSERS \$1
2, 25, 33 or 100 mmf. | <input type="checkbox"/> 100 - 3AG LITTLE FUSES \$1
5 amp or 100 on asst. types | <input type="checkbox"/> 1000-ASST HARDWARE KIT \$1
screws, nuts, washers, rivets, etc. |
| <input type="checkbox"/> 1-5" PM SPEAKER alnico #5 magnet \$1 | <input type="checkbox"/> 100 - ASSORTED 1/2 WATT RESISTORS some in 5% \$1 | <input type="checkbox"/> 10 - ASSORTED TUBES \$1
Radio, TV, Industrial | <input type="checkbox"/> 25 - ASSORTED TV COILS \$1
sync. peaking, width, ratio, etc. |
| <input type="checkbox"/> 1-4" PM SPEAKER alnico #5 magnet \$1 | <input type="checkbox"/> 70 - ASSORTED 1 WATT RESISTORS some in 5% \$1 | <input type="checkbox"/> 4 - TUNG SOL 1U4 TUBES \$1
also serves as a 1T4 | <input type="checkbox"/> \$15.00 TELEVISION PARTS \$1
"JACKPOT" best buy ever |
| <input type="checkbox"/> 1-4" TWEETER SPEAKER for Hi-Fi \$1 | <input type="checkbox"/> 35 - ASSORTED 2 WATT RESISTORS some in 5% \$1 | <input type="checkbox"/> 3 - SYLVANIA 35W4 TUBES \$1
factory cartoned | <input type="checkbox"/> 1 - \$10 INDOOR TV ANTENNA hi-gain, 3 section, tiltproof \$1 |
| <input type="checkbox"/> 5 - SETS SPEAKER PLUGS male & female, wired, long leads \$1 | <input type="checkbox"/> 40 - ASST. PRECISION RESISTORS in 1 percenters \$1 | <input type="checkbox"/> 15 - ASSORTED ROTARY SWITCHES regular \$15 value \$1 | <input type="checkbox"/> 5 - TV CHEATER CORDS with both plugs \$1 |
| <input type="checkbox"/> 3-AUDIO OUTPUT TRANSFORMERS 50L6 type \$1 | <input type="checkbox"/> 20 - ASST'ED WIREWOUND RESISTORS 5, 10, 20 watt \$1 | <input type="checkbox"/> 10 - 6' ELECTRIC LINE CORDS with plug \$1 | <input type="checkbox"/> 100' - TWIN TV LEAD-IN WIRE 300 ohm, heavy duty \$1 |
| <input type="checkbox"/> 3-AUDIO OUTPUT TRANSFORMERS 6K6 or 6V6 type \$1 | <input type="checkbox"/> 50 - ASSORTED TUBULAR CONDENSERS .001 to .47 \$1 | <input type="checkbox"/> 4 - 50' SPOOLS HOOK-UP WIRE 4 different colors \$1 | <input type="checkbox"/> 50' - FLAT 4-CONDUCTOR WIRE many purposes \$1 |
| <input type="checkbox"/> 2 - G.E. I.F. COIL TRNSFRMRS 456kc rTL-143 w/flange \$1 | <input type="checkbox"/> 50 - ASST. CERAMIC CONDENSERS some in 5% \$1 | <input type="checkbox"/> 25' - INSULATED SHIELDED WIRE #20 braided-metal jacket \$1 | <input type="checkbox"/> 20 - ASSORTED TV KNOBS ESCUTCHEONS, \$20 value \$1 |
| <input type="checkbox"/> 3 - I.F. COIL TRANSFORMERS 10.7mc for FM \$1 | <input type="checkbox"/> 50 - ASST. MICA CONDENSERS some in 5% \$1 | <input type="checkbox"/> 35' - TEST PROD WIRE deluxe quality, red or black \$1 | <input type="checkbox"/> 6 - ASSORTED STANDARD TUNER UHF STRIPS \$1 |
| <input type="checkbox"/> 3 - I.F. COIL TRANSFORMERS 262kc for Auto Radios \$1 | <input type="checkbox"/> 35 - ASST. DISC CERAMIC CONDENSERS popular numbers \$1 | <input type="checkbox"/> 50 - STRIPS ASSORTED SPAGHETTI handy sizes \$1 | <input type="checkbox"/> 1 - 90' FLYBACK TRANSFORMER incl Schematic Diagram \$1 |
| <input type="checkbox"/> 4 - OVAL LOOP ANTENNAS assorted popular sizes \$1 | <input type="checkbox"/> 35 - DISC CERAMIC CONDENSERS 5000 mmf \$1 | <input type="checkbox"/> 100 - ASSORTED RUBBER GROMMETS best sizes \$1 | <input type="checkbox"/> 1 - TV VERTICAL OUTPUT TRANSFORMER 10 to 1 ratio \$1 |
| <input type="checkbox"/> 3 - VARIABLE CONDENSERS supermet 420/182 mfd \$1 | <input type="checkbox"/> 25 - ASSORTED MICA TRIMMER CONDENSERS \$1 | <input type="checkbox"/> 50' - HI-VOLTAGE WIRE for TV, special circuits, etc. \$1 | <input type="checkbox"/> 2 - TV RATIO DETECTOR COILS 4.5mc or 10.7mc \$1 |
| <input type="checkbox"/> 3 - ASST. SIZES RADIO CHASSIS PANS drilled & plated \$1 | <input type="checkbox"/> 15 - TUBULAR CONDENSERS .047-600v \$1 | <input type="checkbox"/> 200' - BUSS WIRE #20 tinned for hookups, special circuits, etc. \$1 | <input type="checkbox"/> 2 - TV SOUND I.F. COILS 4.5mc or 21.25mc \$1 |
| <input type="checkbox"/> 12 - RADIO OSCILLATOR COILS standard 456kc \$1 | <input type="checkbox"/> 20 - TUBULAR CONDENSERS .01-600v \$1 | <input type="checkbox"/> 250 - ASST. SOLDERING LUGS best types and sizes \$1 | <input type="checkbox"/> 25 - ASSORTED TV PEAKING COILS all popular types \$1 |
| <input type="checkbox"/> 3 - 1/2 MEG VOLUME CONTROLS with switch \$1 | <input type="checkbox"/> 15 - TUBULAR CONDENSERS .1-600v \$1 | <input type="checkbox"/> 1 - LB SPOOL ROSIN-CORE SOLDER 40/60 \$1 | <input type="checkbox"/> 4 - ASST. TV ION TRAPS for all type TV Receivers \$1 |
| <input type="checkbox"/> 5 - 1/2 MEG VOLUME CONTROLS less switch \$1 | <input type="checkbox"/> 3 - ELECTROLYTIC CONDENSERS 50/30-150v \$1 | <input type="checkbox"/> 200 - ASST. SELF TAPPING SCREWS #6, #8, etc. \$1 | <input type="checkbox"/> 2 - SILICON RECTIFIERS 500ma, 400PIV \$1 |
| <input type="checkbox"/> 5 - ASST. 4 WATT WIREWOUND CONTROLS \$1 | <input type="checkbox"/> 10 - ASST. RADIO ELECTROLYTIC CONDENSERS \$1 | <input type="checkbox"/> 150 - ASST. 6/32 SCREWS & 150 - 6/32 HEX NUTS \$1 | <input type="checkbox"/> 5 - TV PICTURE TUBE SOCKETS wired with 20" lead \$1 |
| <input type="checkbox"/> 10 - ASSORTED VOLUME CONTROLS less switch \$1 | <input type="checkbox"/> 5 - ASST. TV ELECTROLYTIC CONDENSERS \$1 | <input type="checkbox"/> 150 - ASST. 8/32 SCREWS & 150 - 8/32 HEX NUTS \$1 | <input type="checkbox"/> 5 - TV HI-VOLT ANODE LEADS 20" length \$1 |
| <input type="checkbox"/> 10 - SURE-GRIP ALLIGATOR CLIPS 2" plated \$1 | <input type="checkbox"/> 2 - ELECTROLYTIC CONDENSERS 40/40-450v \$1 | <input type="checkbox"/> 100 - ASST. RUBBER FEET FOR CABINETS best sizes \$1 | <input type="checkbox"/> 4 - TV CENTERING RINGS fits on back of deflection yoke \$1 |
| <input type="checkbox"/> 1 - GOLD GRILLE CLOTH 14"x14" or 12"x18" \$1 | <input type="checkbox"/> 3 - ELECTROLYTIC CONDENSERS 80-400v \$1 | <input type="checkbox"/> 8 - ASST. LUCITE CASES hinged cover, handy for parts \$1 | <input type="checkbox"/> 3 - TV ALIGNMENT TOOLS Assortment #1 \$1 |
| <input type="checkbox"/> 10 - SETS PHONO PLUGS & PIN-JACKS RCA type \$1 | <input type="checkbox"/> 5 - DIODE CRYSTALS 2-IN21 1-1N34, 1-1N60, 1-1N64 \$1 | <input type="checkbox"/> 4 - TOGGLE SWITCHES SPST, SPDT, DPST, DPDT \$1 | <input type="checkbox"/> 3 - TV ALIGNMENT TOOLS Assortment #2 \$1 |
| <input type="checkbox"/> 50 - ASSORTED TERMINAL STRIPS 1, 2, 3, 4 lugs \$1 | <input type="checkbox"/> 4 - DIODE CRYSTALS 1-IN34 1-1N60, 1-1N69, 1-1N82 \$1 | <input type="checkbox"/> 6 - ASST. SLIDE SWITCHES SPST, DPDT, etc. \$1 | <input type="checkbox"/> 3 - TV ALIGNMENT TOOLS Assortment #3 \$1 |
| <input type="checkbox"/> 100' - FINEST NYLON DIAL CORD best size, .028 gauge \$1 | <input type="checkbox"/> 3 - SELENIUM RECTIFIERS 2 - 65ma and 1 - 75ma \$1 | <input type="checkbox"/> 35 - CERAMIC CONDENSERS 20-250mmf & 15-470mmf \$1 | <input type="checkbox"/> 3 - TV ALIGNMENT TOOLS Assortment #4 \$1 |
| <input type="checkbox"/> 35 - ASST. RADIO KNOBS screw and push-on types \$1 | <input type="checkbox"/> 25 - ASSORTED SOCKETS 7 pin, 8 pin, 9 pin \$1 | <input type="checkbox"/> 35 - CERAMIC CONDENSERS 20-2000mmf & 15-5000mmf \$1 | <input type="checkbox"/> 3 - TV ALIGNMENT TOOLS Assortment #5 \$1 |

HANDY WAY TO ORDER — Simply pencil mark items wanted (X in square is sufficient), enclose with money order or check. You will receive a new copy of these offers for re-orders.

ON SMALL ORDERS — Include stamps for postage, excess refunded. LARGER ORDERS shipped express charges collect.

BROOKS RADIO & TV CORP., 84 Vesey St., Dept. A, New York 7, N.Y. TELEPHONE CORTland 7-2359

NEW TUBES and SEMI-CONDUCTORS

TUBES ARE BACK IN THE DRIVER'S SEAT, at least for this month. We've a compactron horizontal output tube, three "universal" picture-tube replacements and a medium-mu twin triode for relay-control use. On the semi-conductor end are a series of industrial power transistors and a group of silicon rectifiers.

6GE5

A compactron device for use as

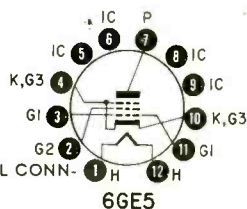

the horizontal deflection amplifier in television receivers. The tube is a single-ended unit 1 3/16 inches shorter than the 6DQ6-B it is intended to replace.

Maximum ratings of the G-E 6GE5 compactron are:

V_p (supply)	770
(peak positive pulse)	6,500
(peak negative pulse)	1,500
V_{G2}	220
V_{G1} (peak negative)	330
P_p (watts)	17.5
P_{G2} (watts)	3.5
I_k (dc ma)	175
(peak)	550

12FV7

A medium-mu twin triode of the 9-pin miniature type designed specifically for use as a relay control tube in remote-control tuning units of TV receivers. The tube is specially processed for long periods of operation under standby (plate-current cutoff) conditions. Its tapped heater can be operated at either 12.6 volts 450 ma or 6.3 volts 900 ma.

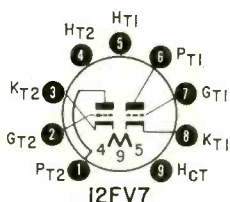

Maximum ratings of the RCA 12FV7 in relay-control service are:

YOU NEED THIS...

FREE GIANT ALL NEW 1962 BA CATALOG

ANNUAL CATALOG 621

1962 RADIO-TV-ELECTRONICS BA SINCE 1927 35th Anniversary

BURSTEIN-APPLEBEE CO. Dept. RE, 1012-14 McGee St., Kansas City 6, Mo.

Rush me New 1962 B-A Catalog No. 621

NAME _____

ADDRESS _____

CITY _____ STATE _____

RUSH COUPON TODAY!

WANT BACK ISSUES?

Copies of most issues of Radio-Electronics are available.

1961 issues	50¢
1960 issues	55¢
1959 issues	60¢

Five cents extra for each earlier year

Radio-Electronics, 154 West 14th St., N.Y. 11, N.Y.

ENGINEERING DEGREE IN SCIENCE MATH 27 or 36 MOS.

B.S. degree—36 mos. • B.E. degree—27 mos.

Accelerated year-round program prepares for early employment in fields of Science and Engineering. Regular 4-year program for B.S. Degree completed in 36 months. special engineering degree program in 27. Classes start June, July, September, January, March. Quality education. Graduates employed from coast to coast. Government approved for veteran training. Students from 50 states, 40 countries, 20 buildings; dorms, gym. Campus. Save time and money. Earn board. Write for catalog. 1742 E. Washington Boulevard, Fort Wayne 2, Indiana

INDIANA TECHNICAL COLLEGE

the shrunken head
you can use!

SHOWN
FULL SIZE



the microscopic tip
of Mueller's
"Micro-gator"
alligator clip

A clip for use where no other will do. For testing in the tightest of spots...on printed circuits, transistors, diodes, crowded terminals. Completely insulated right down to the nose.

CLIP: New keyed-in hinge, traditionally snappy Mueller springs. Wire-clinching ears.



SHOWN
HALF SIZE



INSULATOR: Skin-tight Vinyl insulator. (Sold separately.) Lip-action tip slot. Two standard, and four special colors.

At jobbers' everywhere.

Write factory for free sample packet (Micro-gator, Insulator, Complete new Catalog of all Mueller Clips and Insulators).

Mueller Electric Co.

1567Y EAST 31st STREET • CLEVELAND 14, OHIO

Ask By Name For
GENUINE
"NO NOISE"
PRODUCTS

your assurance
of brand name
quality

NO-NOISE
Volume Control
and **CONTACT RESTORER**
• Cleans
• Protects
2 oz. Bottle
\$1.00
Net to Servicemen

• Lubricates
• Restores
6 oz. Spray Can
\$2.25
Net to Servicemen



Not a Carbon Tet Solution

NO-NOISE
TUNER-TONIC
with **PERMA-FILM**
• Cleans, lubricates, restores all
• Non-toxic, non-inflammable.
• For TV, radio and FM use.
• Economical—a little does a lot.
6 oz. Aerosol can
\$3.25
Net to Servicemen

FREE
with each can of
ELECTRONIC
CHEMICAL
products—
15" PLASTIC
EXTENDER
• Push Button
Assembly
• For Pin Point
Applications
• Does Not
Cause Shorts



Electronic
Chemical
EC-44
Lubricates, cleans
all electrical
contacts. Econ-
omical... a
little does a lot!

6 oz.
spray
can
\$3.50
Net to Servicemen.

ELECTRONIC CHEMICAL CORP.
813 Communipaw Avenue Jersey City 4, N. J.

WANT TO SELL?—buy? trade? find out?

RADIO-ELECTRONICS Classified Ads can bring your results. Only 50¢ a word—minimum 10 words. Send copy with check or money order to:

RADIO-ELECTRONICS

154 WEST 14TH STREET

NEW YORK 11, N.Y.

ELECTRONICS

Engineering-Technicians

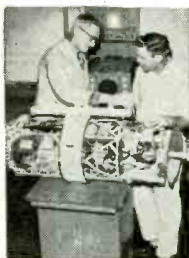

Heald's Micro-
wave and
Radar Labora-
tory Equip-
ment.

Bachelor of Science Degree, 30 Months

Save Two Years' Time

- Radio-Television Plus Color Technician (12 Months)
- Electronics Engineering Technology (15 Months)
- Electronics Engineering (B.S. Degree)
- Electrical Engineering (B.S. Degree)
- Mechanical Engineering (B.S. Degree)
- Civil Engineering (B.S. Degree)
- Architecture (B.S. Degree)

Approved for Veterans
DAY AND EVENING CLASSES

Write for Catalog and Registration Application.
New Term Starting Soon.

Your Name _____

Address _____

City _____

State _____

HEALD'S
ENGINEERING COLLEGE

Established 1863

Van Ness at Post, RE
San Francisco, Calif.

V_p	300
V_G (positive bias value)	0
I_k (ma)	30
P_p (watts when "on" time exceeds 30 seconds in any 2-minute period)	2.5
(watts when "on" time does not exceed 30 seconds in any 2-minute period)	4.5
Typical operating characteristics with a 5,000-ohm relay unit are:	
V_p (supply)	100
I_p (zero bias ma)	36
R_G (megohms)	2.2
V_G (for 1 ma I_p)	-16

"Universal" picture tubes

These new tubes (21CBP4-A, 24AEP4, and 17DKP4) can replace 20 popular types now in use. Made by Sylvania, they are claimed to cut dealer inventory greatly. The tubes do not require an ion-trap magnet.

Here is a list of the "universals" and the types they can replace:

"Universal" Type	Replaces
Type 21CBP4-A	21FLP4 21ALP4A) 21ALP4B) 21ATP4) 21ATP4A) 21BAP4 21BNP4 21BTP4 21CBP4) 21CBP4A) 21CBP4B 21CMP4
Type 24AEP4	24DP4A) 24YP4 24ZP4 24AEP4 24ANP4
Type 17DKP4	17DKP4 17DTP4 17DLP4

T2357

This single type number represents a matched pair of p-n-p Silicon Precision Alloy Transistors (SPAT)

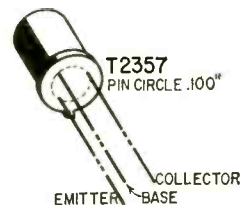

intended for use in low-level chopper applications.

Maximum ratings of the Philco T2357 transistor are:

V_{CBO}	30
V_{EBO}	30
V_{ECO}	30
I_c (ma)	50
P_{total} (mw)	150

Electrical characteristics at 25°C:

f_t (gain bandwidth product)	6.5 mc
C_{ob} (output capacitance)	9 μ f

10C5 through 10C100

A series of 2-amp flangeless silicon diffused-junction rectifiers with voltage capabilities from 50 to 1,000 prv, and a maximum peak surge current of 60 amps, these units are made by International Rectifier. Thanks to a precision-controlled IR diffusion process, they have very low reverse leakage (5 μ a



FM 2-WAY MOBILE RADIOS

SAMPLE OFFERING: 12V 30W or 60W mobile units. Reconditioned General Electric type MC series. Formerly used by N.J. State Police and serviced by N.J. Bell Telephone. Can be tuned and crystalized to frequencies within 30-50MC band.

Complete with accessories less antenna and crystals } 30W \$ 98 ea.
60W \$108 ea.

Complete with accessories including antenna, crystals, fully narrow banded and tuned to your frequency.

30W \$198 ea. 60W \$208 ea.

FM 2-WAY RADIO MOBILE TRANSMITTERS GENERAL ELECTRIC!

4ET3
6V 30W 40-50MC..... \$15

12V 30W 40-50MC..... \$20

4ET6
12V 60W 40-50MC..... \$25

Less Accessories
Prices are FOB our warehouse and all equipment subject to prior sale.

ALSO AVAILABLE: Many reconditioned RCA, GE and Motorola units in 30-50MC, 130-170MC, and 450-470MC bands. Guaranteed prompt, efficient, courteous service.

WANTED . . . FOR CASH!
Late model 2-way radio equipment.
State price, condition, quantity.

GREGORY ELECTRONICS CORPORATION



112 Route 46 Saddle Brook, N.J.
Phone PR 3-7550
Write for new 1962 Catalog

CONVERT TO COLOR TV

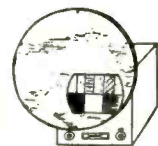

COLORDAPTOR—A simple 10-tube circuit and rotating color wheel converts any size B & W TV to receive compatible color.

COLORDAPTOR — Easily attached to any TV set, does not affect normal operation, often built from parts experimenters have on hand, **BRILLIANT COLOR!**

Complete booklet—gives theory of operation, all construction details, schematic, and sample color filters. **\$195**

Essential Parts Kit—includes all special parts—coils, delay line, crystal, color filters. Add \$1.00 for sets over 16". **\$19.95**

COLORDAPTOR 1798 Santa Cruz, Menlo Park, Calif.

OUT OF SPACE?

You bet we'd be... if we were to tell you all about AUDION's 'Out of this World Hi Fi Values'!

Write for free Catalog
audion
25-E Oxford Road
Massapequa, New York

FREE Catalog

OF THE WORLD'S FINEST
ELECTRONIC GOV'T
SURPLUS BARGAINS

HUNDREDS OF TOP QUALITY ITEMS—Receivers, Transmitters, Microphones, Inverters, Power Supplies, Meters, Phones, Antennas, Indicators, Filters, Transformers, Amplifiers, Headsets, Converters, Control Boxes, Dynamotors, Test Equipment, Motors, Blowers, Cable, Keys, Chokes, Handsets, Switches, etc., etc. Send for Free Catalog—Dept. RE.

FAIR RADIO SALES
2133 ELIDA RD. • Box 1105 • LIMA, OHIO

APRIL, 1962



at rated prv) and very low forward voltage drop (0.95 volt at 3 amps).

MP500-A through MP507-A

A series of industrial power transistors for high-current applications. These p-n-p germanium units are for circuits requiring high gain and extremely low saturation voltage.

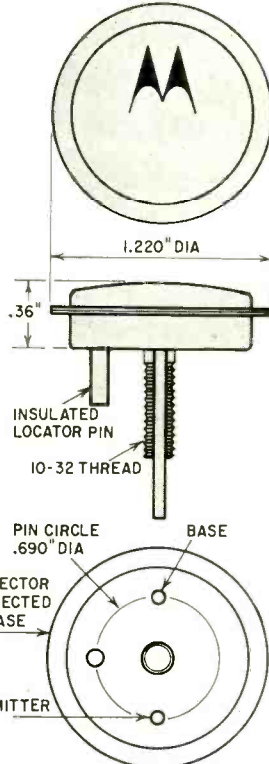

MP500 THROUGH MP507

Maximum ratings of these Motorola transistors are:

	MP500-A	MP501-A	MP502-A	MP503-A	MP504-A	MP505-A	MP506-A	MP507-A
V _{CB0}	45	60	75	90				
V _{CEs}	45	60	75	90				
V _{CEO}	30	45	60	75				
V _{EB0}	25	30	40	45				
I _C (amps)	60	60	60	60				
P _{total} (watts)	170	170	170	170				

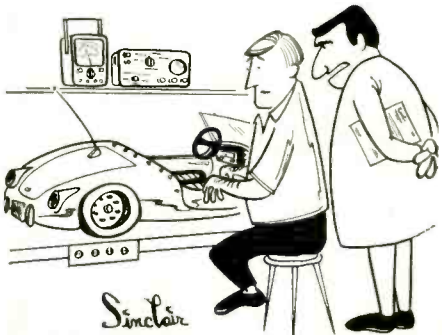

"We generally pull car radios, Feeny."

"TAB" TUBES

Six Months Guarantee! No Rejects!
NEW & Used Gov't & Mfrs. Surplus!

Orders \$10 or more. Receiving types only ppd, 48 states

0A2	.80	6B16	.69	12AT6	.59	18S1	1.00
0B2	.65	6BK7	.99	12AT7	.84	117Z6	1.10
0C3	.69	6BL7	1.25	12AU6	.94	4-65A	16.00
0D3	.35	6BN6	.98	12AU7	.69	2D21	2/S1
0Z4	.59	6BQ6	1.19	12AX7	.79	3D23	3.85
1B3	.78	6C4	1.25	12BA6	.64	17A	9/81
1R5	.78	6C5	.43	12BA7	.99	4-125	29.00
1S4	.78	6CB6	.89	12BD6	.59	4-250	35.00
1T4	.78	6CD6	1.49	12BF6	.59	4PR60	29.50

Send \$5 for Catalog!

1U5	.73	6H6	3/81	12BH7	.99	4X250	35.00
1X2A	1.99	6J6	.52	12BY7	.99	4X500	38.00
3Q5	.89	6J8	.48	12CZ6	1.45	58P4	7.50
3S4	.68	6K6	.59	12CU6	.64	35T	4.00
3V4	.83	6L6	1.19	12DG7	.89	100T	7.00
5R4	.98	6SA	.59	12SH7	.89	316A	5/S1
5U4	.99	6SA7	.69	12SK7	.75	388A	3/S1
5V4	.80	6BT7	1.19	12SQ7	.84	416B	4.00

Wanted Test Equipment from schools & U

5Y3	.59	6C7	.89	12806	2.15	50T	42.00
6AC7	.70	6S7	.79	25B06	1.39	807	1.00
6AG7	.89	6SJ7	.69	25L6	.69	866A	1.89
6AK5	.89	6W4	.79	25W4	.77	811	4.40
6AL5	2/81	6SK7	.72	25Z5	.63	813	9.00
6AG5	.63	6SL7	.89	2525	.63	814	3.45
6AS7	3.00	6SN7	2/81	2526	.75	815	2.75
6AT5	.49	6T8	.98	35L6	.69	829B	8.00

Wanted 811, 818, 815 and 801 TL tubes! Top \$3.3 Paid

8AU4	1.10	6U8	.98	35W4	.49	832A	7.00
8A15	1.10	6V8T	.70	35Z5	.63	872A	3.50
8AU6	.69	6W4	.79	50A5	.69	1625	2/81
8AX4	.79	6W6	.89	50B5	.69	6146	4.00
8BA6	.59	6X4	2/81	50B5	.69	5879	.98
8BD6	.69	6X4	2/81	50C5	.69	5881	2.70
8BE6	.59	6X6	.97	50L6	.69	6550	3.90
8BG6	1.50	6X6	.97	60W7	.80	59	5054
8BH6	.72	7W7	.80				1.00

TUBES WANTED! WE BUY! SELL & TRADE!

"SUPERIOR" Powerstat #10 Variable X FMR
165 Watt 0 to 132V Special \$6 each, 2 for \$10

TRANSISTOR POWER CONVERTER

12VDC to 500VDC up to 200MA

100 Watts Typ at 250VDC

DB500 \$33

12VDC to 250VDC up to 150MA

Type C1225E \$30

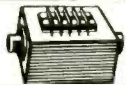

TWO 866A's and FILAMENT \$6

XFMR 10 Kv Insitd SPECIAL!

SILICON POWER DIODE STUDS*

Operation Up to 125°C Case Temp.

D.C. Amps	50Piv 35Rms	100Piv 70Rms	150Piv 105Rms	200Piv 140Rms
2	.25	.35	.45	.55
3	.60	.85	1.00	1.25
6	.70	1.00	1.20	1.50
12	.85	1.20	1.50	1.70
35	1.80	2.15	2.50	2.90
70	3.75	4.50	4.95	5.60
240	4.50	5.70	6.90	8.40

D.C. Amps	300Piv 210Rms	400Piv 280 Rms	500Piv 350Rms	600Piv 420Rms
2	.80	1.00	1.50	1.95
3	1.50	1.80	2.10	2.65
6	1.75	2.00	3.70	5.20
12	2.00	2.20	3.90	5.70
35	4.15	6.10	6.90	8.70
70	10.80	15.30	17.50	21.90
240	19.60	29.75	33.90	42.00

*Derate 20% for Battery or Capacitive Load or D.C. Blocking! *Stud mounted on Heat-sink.

D.C. POWER SUPPLY 115V/60to800Cys Inpt.
330&165VDC Up to 150MA. CASE! SPECIAL \$5

NEW BATTERY CHARGER BC612X

For 6 or 12 Volt Batteries

Trickle & Full Charge up to 10 amps

Charges 6 & 12 volt batteries.

Build ready to use BC612X @ \$14.00

BC612B up to 2 amps. \$7.45



ZENER DIODES 150to400 MW Cased TO24Pkg
Within 20% V Range \$1 @ 3for\$2 20for\$10
KIT ZENER DIODES upto400MW 2for\$1
KIT DOUBLE ENDED ZENER DIODES 2for\$1

"TAB", SILICON 750MA* DIODES

NEWEST TYPE! LOW LEAKAGE
D.C. or Battery. Derate 20%

rms/piv	rms/piv	rms/piv	rms/piv
35/50	70/100	140/200	210/300
.09	.17	.22	.31
280/400	350/500	420/600	490/700
.38	.50	.63	.77
rms/piv	rms/piv	rms/piv	rms/piv
560/800	630/900	700/1000	770/1100
.83	.98	1.08	1.35

Diode order \$10 shipped Post free

Low Price! T300 Silicon Diodes
Rated 400piv/280rms@300Ma@100°C
.25 each; 30 for \$7; 100 for \$22; 500 for \$100

"TAB" FOR TRANSISTORS & DIODES!!!!
Full Length Leads U.S.A. Mfg.

Factory Tested & GTD!

PNP Hi Power 15 Amp, TO3 & TO36 Pkg.
2N441, 2N272 \$12 for \$10
2N442, 2N278 \$3 @ 2N443, 2N174 \$4 @
2N6FF \$1 @ 2N677A \$2 @, 2N6FFB \$3 @
3 amp, 2N155, 2N156, 2N255, 2N256, 2N307, 2N554, TO3GP .49 @, 5 for \$2;
PNP 2N123, 2N107, CK722 5 for \$5 PNP 2N292, 293; PNP 2N223 \$30 @ 12 for \$9, 100 for \$65;
PNP 2N670/300MW \$5 @, 10 for \$4
PP 2N671 1 Watt \$7 @, 10 for \$6
Round or Diamond Base Mica Mtg Kit \$30 @, 10 for \$2
Power Heat Sink Fins 80 Sq 51.39
Kit Glass Diodes equiv. 1N34A, 46, 48, 51, 12 for \$1, 100 for \$6, 1000 for \$50

GTD! Octal Silicon-SU4G-Tube Replacement
1120Rms 1600Piv \$4 @; 2 for \$6; 4 for \$10
5R4 Silicon 1900/2800Piv \$4
866A Silicon 5000/10400Piv \$9

"TAB" TERMS: Money Back Guarantee!

Our 18th year. \$2 min. order
F.O.B. N.Y.C. Add ship charges
or for C.O.D. 25% Dep. Prices
shown subject to change.

111-GD Liberty St., N.Y. 6, N.Y.

Send 25¢ for Catalog

PHONE: RECTOR 2-6245

priced from \$109.50...
HAND-HELD, MOBILE, BASE STATION
2-WAY RADIO

VIKING MESSENGERS

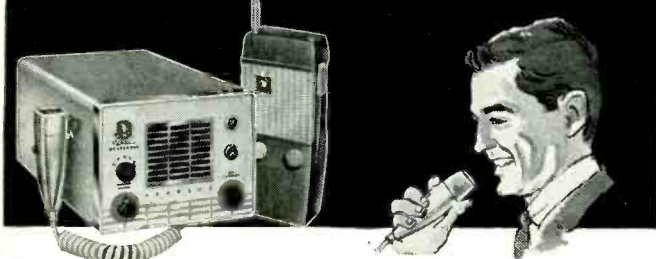

**Now, 3 feature packed Johnson Messengers...
 outperforming everything else in the field!**

Compact, hand-held 100 milliwatt or 1 watt "Personal Messengers". Rugged and reliable—11 transistors, 4 diodes! Superheterodyne receiver and exclusive tuned RF amplifier gives twice the sensitivity and 40% more range than similar units with conventional circuitry—more output than similar units with same rated inputs!

For mobile or base stations—performance proved Viking "Messenger" punches your signal across the miles! High efficiency design makes full use of maximum allowable legal power. Excellent receiver sensitivity and selectivity. Automatic "squelch" control—5 channel coverage. Only 5 1/2" x 7" x 1 1/2", easy to install anywhere!

WRITE TODAY
 for
 information packed
4 Color Catalog



E. F. JOHNSON COMPANY

1105 10th Ave. S.W., Waseca, Minnesota

Please rush "Messenger" details to:

NAME _____

ADDRESS _____

CITY _____ STATE _____

Manufacturers of the world's most widely used personal communications transmitters.

SUPERIOR'S NEW MODEL 85 TRANS-CONDUCTANCE TYPE
TUBE TESTER

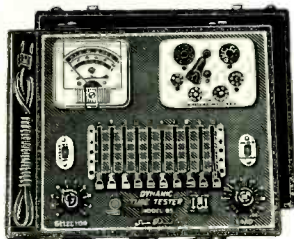

Model 85—Trans-Conductance Tube Tester. Total Price \$52.50
 Terms: \$12.50 after 10 day trial, then \$8.00 monthly for 5 months if satisfactory. Otherwise return, no explanation necessary.

● **FREE FIVE (5) YEAR CHART DATA SERVICE.** Revised up-to-date subsequent charts will be mailed to all Model 85 purchasers at no charge for a period of five years after date of purchase.

Model 85 comes complete, housed in a handsome portable cabinet with slip-on cover. Only \$52.50

SHIPPED ON APPROVAL
NO MONEY WITH ORDER — NO C.O.D.

Try it for 10 days before you buy. If completely satisfied then send \$12.50 and pay balance at rate of \$8.00 per month for 5 months—No interest or finance charges added. If not completely satisfied, return to us, no explanation necessary.

MOSS ELECTRONIC, INC. All prices net. P.O.B., N.Y.C.
 DEPT. D-927, 3849 Tenth Ave. New York 34, N. Y.
 Please rush Model 85. If satisfactory, I will pay on terms specified. Otherwise I will return tester.

Name _____
 Address _____
 City _____ Zone _____ State _____

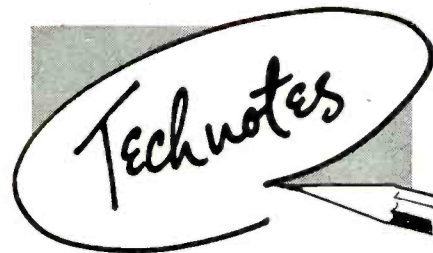

FOCUS CONTROL BURNOUT

Several RCA 800 series color receivers may come to the shop with the focus control burnt out. Experience shows that this often happens because the black voltage wire from the picture tube socket to R122 has been pinched under the compartment cover of the high-voltage cage. This causes arcing that results in the focus control burning out. When reinstalling the high-voltage compartment cover, make sure that this lead is placed in the cutout in the cover provided for it, and not under the cover itself.—*RCA Television Service Tips.*

ADMIRAL 14YP3D

A common complaint on this set is sound OK and a single horizontal line across the center of the screen. You'll usually find the trouble in the vertical sync section. Capacitor

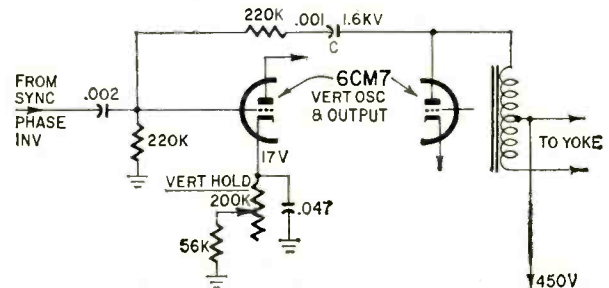

C shorts, allowing a large portion of the boosted B-plus voltage to appear on the grid and cathode of the vertical oscillator. This cuts the tube off and kills vertical sweep. Replacing the capacitor is the obvious solution.—*Dee Bramlett, Jr.*

CHECK 6CD6-GA OPERATION

In some RCA KCS68 and KCS81 television chassis, the 6CD6-GA beam-power tube has failed because of improper operation of the horizontal deflection circuit.

Since "plate emission" may cause the 6CD6-GA to fail in some chassis when it is operated above the maximum allowable peak negative voltage of 1,500, RCA recommends that you use the device outlined in Fig. 1 to measure the peak negative voltage of this tube.

Connect an 1B3-GT, a 500- μ f ceramic capacitor and a 1.5-volt battery as shown.

Remove power from the TV chassis. Connect the lead from the filament of the 1B3 to the plate of the 6CD6. Then connect the lead from the capacitor to the TV chassis under test.

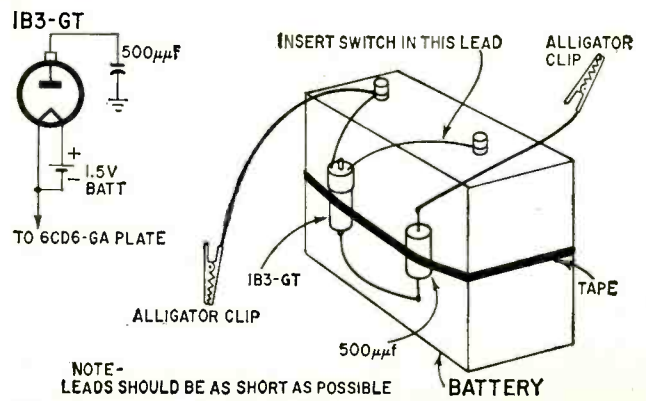

Fig. 1

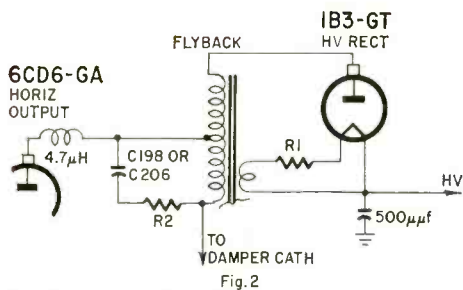

Fig. 2

Apply power to the TV chassis. Picture must be in sync.

Using a vtvm and a high-voltage probe, measure the voltage on the plate of the 1B3 in the test device. It should not exceed 1,500 volts.

RCA further recommends:

If the voltage measured exceeds 1,500, then connect a wire wound 5,000-ohm, 5-watt, 10% resistor (R2 in Fig. 2) to capacitor C198 (KCS81) or capacitor C206 (KCS68) of the horizontal deflection circuit.—*RCA Service News*

TRANSFORMER REPLACEMENT

Sometimes we run into the problem of replacing a small audio or vertical output transformer where it is either almost impossible to drill out the rivets without damaging parts, or time could be saved by using a better approach.

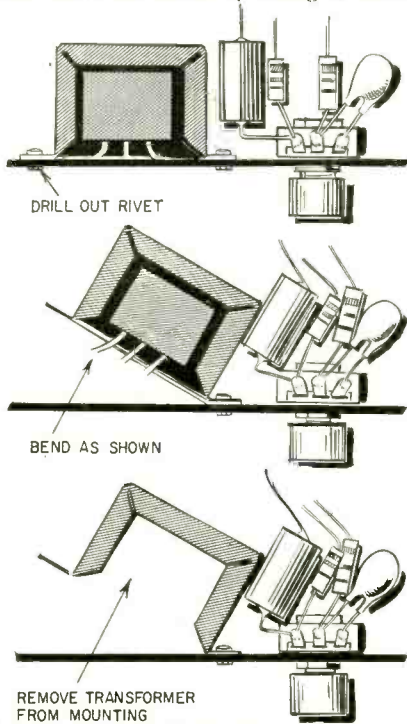

When using an exact replacement or a unit having similar dimensions, try this method: Drill out the closest or easiest to get at rivet, leaving room to get at it. Next, remove the strap around the core of the transformer, as in the diagram, and do the same for the replacement. Then replace the new transformer, less mounting strap, into the old transformer form. Last, fasten the mounting strap back in place with a nut, washer and screw where the rivet was drilled out.—*George P. Oberto* END

WE BUY INDUSTRIAL TECHNOTES

RADIO-ELECTRONICS wants Industrial Technotes. These should cover equipment (including closed-circuit television) actually used in industrial work, or technotes on counters, controls and other apparatus whose users are largely industrial. Unillustrated Technotes pay \$5; circuit diagrams raise the price to \$9 and acceptable photos are worth \$7 each. Send your technotes from industry to Technotes Editor, RADIO-ELECTRONICS, 154 W. 14th St., New York 11, N. Y.

Try This Handle!

It's the New

VACO®

Bull Driver



Here's the best handle you've ever seen on a screw driver!

Try it for grip. Ah! Real Comfort. Try it for ruggedness! Feel how that big handle lets you apply more power! Tough jobs go fast, easy!

The blade? It's made of the finest heat treated chrome vanadium steel to far exceed U. S. Torque Standards for strength.

Technicians have asked for this better, bigger handled driver and now VACO, America's Leading Screw Driver Manufacturer, has made it available. Try a Bull Driver today. There is nothing else like it!

**35%
More
Power**

**35%
Bigger
Handle**

**100%
More
Comfort**



Look For This Display At Your Jobbers

VACO COMPAR-O-GRAPH lets you COMPARE Bull Driver with a standard screw driver. See and feel the powerful difference!

VACO PRODUCTS COMPANY, 317 East Ontario St., Chicago 11, Ill.

In Canada: Vaco-Lynn Products, Ltd. and Atlas Radio Corp.

LEARN

electronics theory this easy way.
No previous technical knowledge required.

BUILD

the finest professional quality TV Set
on a practical "pay-as-you-wire" plan.

SAVE

up to 1/2 on cost of equivalent
educational course plus TV set.

Build the Transvision "Professional" TV Kit described below and get this complete course of study for \$7.95 (available only to Transvision Kit builders.)

Requires no previous technical knowledge. Prepared by experts in teaching novices about electronics.

YOU LEARN: About block diagrams... How to read and follow electronic circuits... How to use basic measuring instruments... Theory and operation of basic electronic circuits... How to service TV, Radio, and other types of electronic equipment.

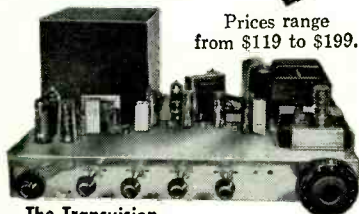
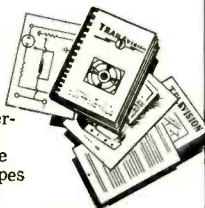

Prices range from \$119 to \$199.

The Transvision "Professional" TV Kit
Choice of 19", 23", or 27" Picture Tube... Easy "Pay as You Wire" Terms... Only \$15 for the Starting Package.



A few of the Professional Quality Features of Transvision TV Kits:

Choice of push-pull 10-watt audio or output to your Hi-Fi System... D.C. restoration... Ultra-linear sweep circuits... Standard Coil Model PKO Automatic Tuner... Super-sensitivity for fringe areas... Complete line of Accessories for Custom Installations.

U. S. Armed Services and over 4000 schools and colleges have selected Transvision Receivers for educational television.

ASSEMBLY MANUAL—\$2.00

See how easy it is to assemble the Transvision Kit. Cost of Manual refunded on purchase of Kit.

TRANSVISION New Rochelle, N.Y.
NE 6-6000

START NOW — MAIL THIS COUPON —
TRANSVISION Electronics, Inc., New Rochelle, N.Y. Dept. RE-L
 Send FREE 12-page Catalog... I enclose \$2 for Assembly Manual, refundable on purchase of Kit.
 I enclose \$15 for Starting Pkg. on pay-as-you-wire plan. (Complete Kits range from \$119 to \$199.)

Name _____
Address _____
City _____ Zone _____ State _____

TECHNICIANS' NEWS

INDIANA REPORTS

Kokomo—RTSEA members discussed the possibility of compiling a list of dead-beat customers for distribution among all members. The list would warn individual technicians who might otherwise get stuck and make possible unified refusal to do any servicing until earlier bills had been paid. Until the dead-beat paid his past-due bills, no one would repair his set.

St. Joseph Valley—ARTS elected new officers. The new president is Lew Woods; vice president, Bill Rapport; secretary, Russ Bills; Treasurer, Dick Tepe, and Sergeant at Arms, Ralph Zeller.

Indianapolis—ITTA reduced its initiation fee to \$10 to spark a membership drive and has instituted a job placement committee to serve members and nonmembers.

Dubois County—SIETA is pushing for better attendance. A program has been set up to give additional in-

struction in the use of test equipment, particularly the oscilloscope.

WISCONSIN CIRCUIT

Jefferson-Dodge County—Dues were increased retroactive to the 1961 convention. Frank Sherman was accepted as a new association member. Educational films from the University of Michigan will be obtained for showings at TESA meetings.

Milwaukee—Jerry Hall commented on state association activities. The more than 20 attending members were in favor of joining the state association.

ARTSD ELECTION RESULTS

Columbus, Ohio—The Associated Radio & Television Service Dealers met at the Nationwide Inn and elected new officers for 1962. When the vote had been taken, the new president was Jack Voigt; vice president, Frank Shannon; recording secretary, Walt Driscoll; corresponding secretary, Rex Rice and treasurer, Paul Boyer.

DO-IT-YOURSELF TV REPAIRS

Portland, Ore.—New trend in TV repairs: rent space and equipment to

the
business-like
approach

to
SERVICE
CHARGES
and
RECORD
KEEPING

Pure Rice's
OFFICIAL PRICING DIGEST

COME TO REAL PRICES on:
Amplifiers
Tuners
Recorders
Speakers
and many more

LEVEL SET SERVICE FEE IN THE LOW-TO-MID PRICE RANGE

For customer's prices on every replacement part, plus flat rate and hourly service charge data, regional and national. Dave Rice's OFFICIAL PRICING DIGEST, listing over 63,000 items. \$2.50.

▲ AVAILABLE FROM YOUR DISTRIBUTOR ▼

If you want to operate on a professional level, Dave Rice's OFFICIAL ORDER BOOKS give you triplicate forms for order, invoice, and office records...spaces for tubes, parts, serial numbers, labor and tax charges, signatures, etc. 75c per book, \$6.50 for dust-proof box of 10. *Pure Rice's*

Pure Rice's
OFFICIAL ORDER BOOK

ELECTRONIC PUBLISHING COMPANY, INC.
133 N. Jefferson St. • Chicago 6, Ill.

YOU SAVE MONEY!

RUSH US YOUR LIST OF HI-FI COMPONENTS FOR A SPECIAL QUOTATION

WRITE FOR FREE AUDIO DISCOUNT CATALOG A-15

New low prices on amplifiers, tuners, tape recorders, speakers, etc.

KEY

ELECTRONICS CO.
120 LIBERTY ST.
NEW YORK 6, N.Y.

the customer so he can make his own repairs. O'Brien's TV & Appliances set up the following system:

The customer can call for pickup and delivery, if he wishes, for \$1.50. He can rent space at the shop for \$1 for the first 2 hours; get a basic kit of hand tools for 50¢ an hour; check tubes and get a half hour of troubleshooting free and replace needed parts himself.

HOUSEWIVES' PEEVES

Housewives, asked about their pet peeves regarding service technicians, had several. The wise technician will try to avoid these more common causes of irritation in dealing with women:

"A technician I called in once was a terrible gossip. He told me about my neighbor down the street who hadn't paid her bill. I thought that if he told me about her, he would just as soon tell others some bit of gossip about me. I never called him again."

"My pet peeve is the noisy technician. He always seems to arrive just after I put the children to bed for their afternoon nap. He stomps in the house, drops his tool box on the floor with a thud, and talks in a loud voice that can be heard all the way down the street. I realize a technician has to make some noise, but some of them overdo it!"

"I don't like the know-it-all who says he can't explain the trouble to me because I wouldn't know what he was talking about anyway. What he doesn't

realize is that I've been using TV for quite some time. I may know a lot more than he gives me credit for."—Philco Service-Businessman

CUSTOMERS PAID FOR TV TROUBLES

Boston, Mass.—An independent TV distributor, Shawmut's TV, is offering to pay his customers for their TV troubles. Here's how it works: You buy a Motorola TV set from Shawmut's. If during the first year any tube or part fails, they will pay you \$1 and make the repair free. If the picture tube fails, they will replace it and give you \$5. If the power transformer fails, they will give you a comparable new Motorola TV.

The firm points out that the replacement of tubes and parts is covered by the Motorola guarantee and that the installation and monetary contribution are Shawmut's own free offer.

COLOR TV FOR TSA

Detroit—RCA's training center was filled with 85 independent technicians from the Television Service Association of Michigan not too long ago. They were there to sit in on a service meeting for color TV. Alignment and other adjustments were demonstrated during the session. Future meetings will cover convergence, setup procedures and other facets of color TV. END

BUILD THE FINEST Professional Quality CUSTOMIZED TV KIT

On Easy "Pay As You Wire" Terms
Only \$15 for the Starting Package!

The "PROFESSIONAL" Series—designed for the perfectionist seeking the finest in TV performance. Easy to assemble. No technical knowledge required. An ideal "Learning" Kit with a Complete Course of Study is available.

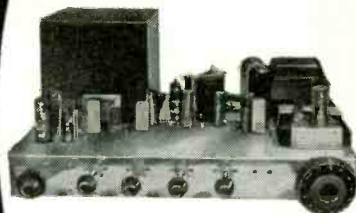

Also available: WIRED CHASSIS for custom installations with a choice



of vertical or horizontal controls and the newest 19", 23" or 27" Picture Tube.



Beautiful Cabinets — designed to enhance sound quality and blend with modern decor. For TV or combination TV and Hi-Fi.

A few of the Professional Quality Features:

Choice of push-pull 10-watt audio or output to your Hi-Fi system . . . D.C. Restoration . . . Ultra-linear sweep circuits . . . Newest Standard Coil Model PKO Automatic Fine Tuner . . . Super-sensitivity for fringe areas . . . Complete line of Accessories for Custom Installations.

CHOICE OF 19", 23" or 27" CRT. Prices range from \$119 to \$199.

U.S. Armed Services and over 4000 schools and colleges have selected Transvision Receivers for educational television.

Interested in Electronics?

Learn the basic principles of electronics from the Course available with the Kit.

ASSEMBLY MANUAL—\$2.00

See how easy it is to assemble the Transvision Kit. Cost of Manual refunded on purchase of Kit.

TRANSVISION New Rochelle, N.Y.
NE 6-6000

START NOW — MAIL THIS COUPON

TRANSVISION Electronics, Inc., New Rochelle, N.Y. Dept. R.E.T.
 Send FREE 8-page Catalog. I enclose \$2 for Assembly Manual, refundable on purchase of Kit.
 I enclose \$15 for Starting Pkg. on pay-as-you-wire plan. (Complete Kits range from \$119 to \$199.)

Name _____
Address _____
City _____ Zone _____ State _____

Get ahead in SERVICING

Write for details about the
GERNSBACK LIBRARY
TECHNICIANS BOOK CLUB
Gernsback Library, Inc.
154 West 14th St., N.Y. 11



HI-FI RECORDING TAPE
Splice Free (except 2400') Freq. Resp. 20, 20,000 cps. 15 day money-back guarantee

	3-11	12-23	24+
1200' 7" Acetate	\$1.29	\$1.17	99¢
1800' 7" Acetate	1.79	1.59	1.45
1800' 7" Mylar	1.99	1.95	1.85
2400' 7" mylar	2.69	2.59	2.49
2400' 7" tensitized mylar	2.99	2.95	2.90

Can Be Assorted. Add 15¢ Postage Per Reel
10¢ for 24+ Lot Orders

HI-FI COMPONENTS, TAPE RECORDERS
At wholesale prices shipped within 24-48 hours. We'll airmail low quotes on your packaged Hi-Fi inquiries. Send for free wholesale catalogue.

CARSTON 125-RD East 88 St.
New York 28, N. Y.

8 **TRANSISTOR** **14 95**
SUPER POWERFUL 3 or more
RADIO COMPLETE
Add 10% for less than minimum quantities.

HI-FI STEREO OUTFIT **95**
4 or more

• 6 GM-14 watt stereo amplifier • VM-4-speed stereo record changer (with base & stereo Cartridge) • 2-Fine 7-way Hi-Fi speakers.

TWO-SPEED RECORD PLAYER
17"-33" & 45" and All in One
HIFI 6 TRANSISTOR RADIO **39 95**
3 or more

COMPLETE POCKET SIZE HI FI

Write, phone, or wire for FREE Catalog.

GME PHOTOELECTRONICS
623 South Gay Street KNOXVILLE, TENNESSEE

SILICON RECTIFIERS **750 MA**
Factory Direct **TOP-HATS**
MFG. PRICES

Low leakage Newest Type			
PIV/RMS 50/35 .07 ea.	PIV/RMS 100/70 .15 ea.	PIV/RMS 200/140 .20 ea.	PIV/RMS 300/210 .29 ea.
PIV/RMS 400/280 .35 ea.	PIV/RMS 500/350 .55 ea.	PIV/RMS 600/420 .70 ea.	PIV/RMS 700/490 .70 ea.
PIV/RMS 800/560 .79 ea.	PIV/RMS 900/630 .90 ea.	PIV/RMS 1000/700 1.00 ea.	PIV/RMS 1100/770 1.20 ea.

General Purpose 400PIV at 300MA
Special 2 for .50 25 for 6.00
100 for 20.00

100 Different prec. res., 1/2 W, 1 W, 2 W
of 1/2%, 1% Tolerance. Only \$1.25

General Electric 1N91 Power Junction
Diode 10 for \$1.00

Inf. Rect. Selenium PIV440/RMS160
DC Current 10MA 10 for \$1.00

PIV	Current	Price	PIV	Current	Price
200	2 Amps	.50	400	15 Amps	2.10
400	2 Amps	.85	50	50 Amps	2.40
100	15 Amps	1.20	100	50 Amps	3.15
200	15 Amps	1.65	200	50 Amps	4.10

All material guaranteed. \$2.00 min. order. Orders F.O.B. NYC. Include check or money order. Shps. charges plus. C.O.D. orders 25% down.

WARREN ELECTRONICS CO.
NYC 7, NY 87 Chambers St. WO 2-5727

34¢ EACH

ELECTRONIC MARKET

1 YEAR GUARANTEED RADIO-TV TUBES

\$32 per 100

All tubes not necessarily new, but may be electronically perfect factory 2nds or used. Each clearly marked. ELECTRONIC MARKET will replace FREE any tube that becomes defective in use within 1 year from date of purchase. All tubes individually boxed and marked. Partial Listing Only—Thousands More Tubes in Stock!

D24	SAV8	GAX5GT	GCH8	6SK7	12BH7
147GT	5A74	6B8	6CL6	6SL7	12B06
1B3GT	5C6B	6BA6	6CM6	6S0T	12BR7
145GT	5R4	6BC5	6CM7	6SR7	12CA5
1S5	5T8	6BC8	6CN7	6T4	12D4
1T4	5U4	6B0B	6C0B	6T8	12F8
1U5	5UB	6BE6	6CR6	6U5	12L5
1W2	5V4G	6BE5	6C57	6V6GT	12K7
1X2	5V6GT	6BC6G	6CU6	6X5GT	12L6
2A74	5X0	6B8G	6CU6	6X4	12Q7
2B4	5Y3	6B9E	606	6X5GT	12R5
2C95	6AB4	6BK5	606E	606	12SA7
2C95	6AB4	6BK5	606E	606	12S17
3AL5	6AH4GT	6B7	606GT	6V6G	12A8
18C5	6AG6	6RL7GT	606G	12A8	12S17GT
3B8G	6AL5	6B8G	6F6	12AB5	12S07
3B7G	6AN8	6B06GT	6H6	12A76	12V6GT
3BC6	6AQ6	6B07	6I5	12A76	12W6GT
354	6A07	6B8B	6I7	12A76	12W6GT
3V4	6AR5	6B58	6K6GT	12A76	12X4
4B07A	6AS5	6BY5G	6Q7	12A77	198A4GT
4B5B	6AT6	6B76	6S0T	12A27	19T8
4B27	6AU4GT	6C4	6S07GT	12B4	25Z6GT
4C86	6AUSGT	6C4	6S07GT	12B4	25Z6GT
5AN8	6AU6	6CA8	6SF5	12B47	35A5
5AN8	6AY5GT	6CB6	6S67	12B06	35B5
5AT8	6AV6	6C06G	6SW7	12BE6	35C5
	6AX4GT	6CF6	6S17	12BF6	35W4

ORDER SHIPPED SAME DAY RECEIVED.

SHIPPING INSTRUCTIONS: ELECTRONIC MARKET PAYS YOUR POSTAGE on orders of \$10 or more in U.S.A. and Territories. Send approx. postage on Canadian and foreign orders. Any order less than \$10 requires 25c handling charge. Send 25% on C.O.D.'s. ANY RECEIVER TUBE NOT LISTED ALSO AVAILABLE AT 34¢ EACH!

25¢

QUANTITY DISCOUNT

When purchasing lots of 50 or more same type tube Applies to tubes below only

6SN7	1L4	12AX7	12CH5	6I6	50C5
6AX4	1R5	6AQ5	12BA6	6N7	6AW8
6AU4	6S4	6C67	12SN7	6K7	6AM8
6E8B	12AU7	6CG8	12BY7	6AC7	6AF4
6AU8	12AT7	6AR5	6U8	6W4	6AG5

74¢

SILICON RECTIFIERS

500 MA - 'TOP HAT' ALL PURPOSE Epoxy construction

\$49 per 100

COMPLETE LINE OF INDUSTRIAL TUBES

ONE OF THE LARGEST INVENTORIES IN THE COUNTRY

ELECTRONIC MARKET

3750 E. 10th CT., HIALEAH, FLORIDA
Phone: OXford 1-5331



Save 30% on 4-track Stereo Music on Tape!

Empty 3 in. plastic reels 7¢ ea.

BARGAIN PRICES!

SEND FOR OUR FREE

Tape Recorder/Blank/Recorded Tape Catalog
SAXITONE TAPE SALES
(Div. of Commissioned Electronics Co., Inc.)
1776 Columbia Road Washington, D.C.

TV PICTURE TUBES

All Aluminized Glass Types. BUY DIRECT AND SAVE

• 12LP4—\$8.95 • 17B4—\$9.95 • 21AL/ATP4—\$16.75
• 24DP4—\$24.50 • 27EP4—\$39.95

ALL TYPES AVAILABLE
These tubes are made from reprocessed glass. All materials including electron gun are brand new.

PICTURE TUBE OUTLET
2922 MILWAUKEE • Chicago 18
FREE... Write for complete Picture Tube list.

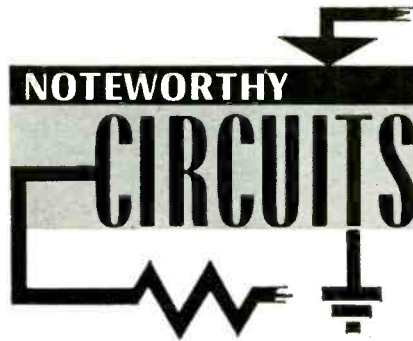

BRIDGE SAVES TRANSISTORS

Incorrect polarity can damage transistors and electrolytic capacitors. In experimental setups where supply

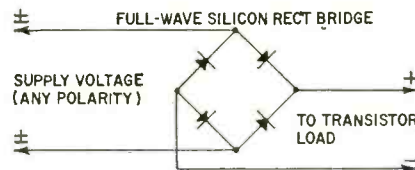

leads may be connected and disconnected any number of times, it is easy

to make a mistake. When experimenting with transistors, I eliminate the possibility of damaging components with a simple full-wave silicon rectifier bridge. When the bridge is connected between the supply and the load circuit as shown, power supply polarity is unimportant. Just remember to leave the bridge connected to the load circuit until the tests are completed.

The rectifiers are selected to handle the voltage and current drawn by the load.—Herbert E. Pasch

ELECTRONIC MOTOR USES TUNNEL DIODE

This new electronic dc motor uses a tunnel diode, bar magnet and two-terminal coil to provide either rotary or pendulumlike reciprocating motion. It is designed to replace the more complex transistorized motors in electric watches and clocks. The circuit (cov-

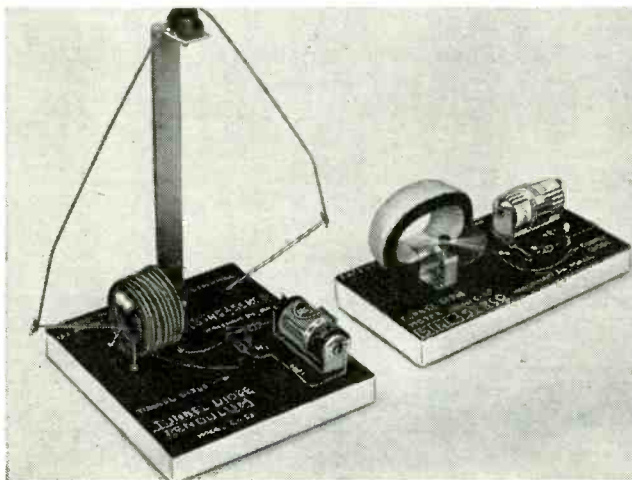
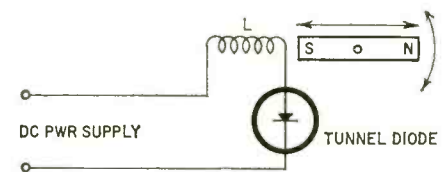

ered by patent application) is shown in the diagram. Two models, made for educational purposes by Sine-Ser Co. (Waltham 54, Mass.), are shown in the photo.

There are no moving parts to require maintenance. The pendulum model starts by itself. The rotary model requires a slight push on the magnet to get it started.—Dr. H. E. Stockman

SIMPLIFIED SWITCHING FOR AC-DC EQUIPMENT

Equipment designed for 117 volts ac and 6 or 12 volts dc generally has a

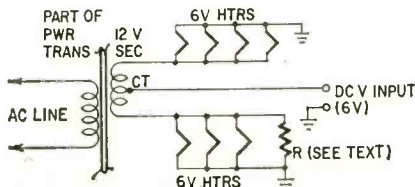

complex circuit for switching the heater string from one source to the other. Here is a circuit that does away with all complicated switching.

For a 6-volt dc/117-volt ac circuit, the wiring is as follows: A 12-volt center-tapped filament winding is used, and the tubes are connected from each side to ground. The current drain on each side is equalized by a resistor (R) on

one side, if necessary. On ac, the 12 volts is impressed across the two strings in series, and the tubes each receive 6 volts. On dc, the voltage is applied between transformer center tap and ground. Since the resistance of the transformer winding is low, there is hardly any voltage drop and the two strings are effectively connected in parallel across the source.

For 12-volt operation, use a 24-volt center-tapped transformer and 12-volt tubes in two parallel strings as shown in the diagram.—*Matthew Fichtenbaum, WA2UFD*

PHOTORELAY MODIFICATION

This modification will lock in a photocell or phototube relay when the light beam is momentarily interrupted. Rather than using a separate or more complex relay, the standard single-pole double-throw relay, wired as shown, will usually work. A toggle switch may be used to override this feature and, by momentarily setting it to "override,"

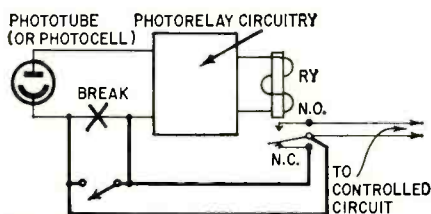

reset the relay. Watch for leakage between the controlled circuit and the photorelay input.—*Richard Koplou* END

50 Years Ago

In Gernsback Publications

HUGO GERNSBACK, Founder

Modern Electrics.....	1908
Wireless Association of America.....	1908
Electrical Experimenter.....	1913
Radio News.....	1919
Science & Invention.....	1920
Practical Electrics.....	1921
Television.....	1927
Radio-Craft.....	1929
Short-Wave Craft.....	1930
Television News.....	1931

Some larger libraries still have copies of Modern Electrics on file for interested readers.

In April, 1912, *Modern Electronics* Stopping Trains by Wireless, by Frank C. Perkins.

Apparatus for Testing Detector Minerals, by our Paris correspondent.

The Poulsen System, by Dean Farran.

New Fessenden Station in Brooklyn.

Mercury Transmitting Condenser, by Stuart R. Ward.

A Silicon Detector, by C. W. Seaman.

A Good Electrolytic Detector, by Lewis C. Mumford.

SOMETHING ON

C B

EVERY MONTH IN
Radio-Electronics

don't miss it!
subscribe now...

1 YEAR	\$5
2 YEARS	\$9
3 YEARS	\$12

RADIO-ELECTRONICS
164 WEST 14TH ST.
NEW YORK 11, N.Y.



TV-RADIO Servicemen or Beginners...

Send for *Coyne's*
7-Volume Job-Training Set
on 7-Day **FREE TRIAL!**



The First
Practical
TV-RADIO-
ELECTRONICS
Shop
Library!

Answers ALL Servicing Problems QUICKLY . . .
Makes You Worth More On The Job!

Put money-making, time-saving TV-RADIO-ELECTRONICS know-how at your fingertips—examine Coyne's all-new 7-Volume TV-RADIO-ELECTRONICS Reference Set for 7 days at our expense! Shows you the way to easier TV-Radio repair—time saving, practical working knowledge that helps you get the BIG money! How to install, service and align ALL radio and TV sets, even color-TV, UHF, FM and transistorized equipment. New photo-instruction shows you what makes equipment "tick". No complicated math or theory—just practical facts you can put to use immediately right in the shop, or for ready reference at home. Over 3000 pages; 1200 diagrams; 10,000 facts!

SEND NO MONEY! Just mail coupon for 7-Volume TV-Radio Set on 7-Day FREE TRIAL! We'll include the FREE BOOK below. If you keep the set, pay only \$3 in 7 days and \$3 per month until \$27.25 plus postage is paid. Cash price only \$24.95. Or return set at our expense in 7 days and owe nothing. Either way, the FREE BOOK is yours to keep. Offer limited, so act NOW!

"LEARNED MORE FROM THEM THAN FROM 5 YEARS WORK!"

"Learned more from your first two volumes than from 5 years work."
—Guy Bliss, New York

"Swell set for either the serviceman or the beginner. Every serviceman should have one."
—Melvin Masbruch, Iowa.

FREE DIAGRAM BOOK!

We'll send you this big book, "150 Radio-Television Picture Patterns and Diagrams Explained" ABSOLUTELY FREE just for examining Coyne's 7-Volume Shop Library on 7-Day FREE TRIAL! Shows how to cut servicing time by reading picture-patterns, plus schematic diagrams for many TV and radio sets. Yours FREE whether you keep the 7-Volume Set or not! Mail coupon TODAY!



Like Having An Electronics Expert Right At Your Side!

- VOL. 1—EVERYTHING ON TV-RADIO PRINCIPLES! 300 pages of practical explanations; hundreds of illustrations.
- VOL. 2—EVERYTHING ON TV-RADIO-FM RECEIVERS; 403 pages; fully illustrated.
- VOL. 3—EVERYTHING ON TV-RADIO CIRCUITS! 336 pages; hundreds of illustrations, circuit diagrams.
- VOL. 4—EVERYTHING ON SERVICING INSTRUMENTS! How they work, how to use them. 368 pages; illustrated.
- VOL. 5—EVERYTHING ON TV TROUBLESHOOTING! Covers all types of sets. 437 pages; illustrations, diagrams.
- VOL. 6—TV CYCLOPEDIA! Quick and concise answers to TV problems in alphabetical order, including UHF, Color TV and Transistors; 868 pages.
- VOL. 7—TRANSISTOR CIRCUIT HANDBOOK! Practical Reference covering Transistor Applications; over 200 Circuit Diagrams; 410 pages.

ALL 7 BOOKS HAVE BRIGHT, MODERN, VINYL CLOTH WASHABLE COVERS

FREE BOOK—FREE TRIAL COUPON!

Educational Book Publishing Division
COYNE ELECTRICAL SCHOOL

1455 W. Congress Parkway, Dept. 42-RE, Chicago 7, Illinois

Yes! Send me COYNE'S 7-Volume Applied Practical TV-RADIO-ELECTRONICS Set for 7-Days FREE TRIAL per your offer. Include "Patterns & Diagrams" book FREE!

Name Age

Address

City Zone State

Check here if you want Set sent C.O.D. Coyne pays postage on C.O.D. and cash orders. 7-Day Money-Back Guarantee.

Coyne ELECTRICAL SCHOOL 1455 W. Congress Parkway, Dept. 42-RE, Chicago 7, Illinois

NEW!

MA-300 only
\$34.95 list



**WINEGARD Transistor TV-FM
TENNA-BOOST**
Mounts on Any Antenna!

19 DB GAIN! CUTS SNOW . . . BOOSTS SIGNAL
Make any TV or FM Antenna work better by amplifying signals with the new Winegard Tenna-Boost.

19 DB gain—no peaks and valleys. Linear frequency response—extremely low VSWR. All AC power supply.



Because of its extra power, the Winegard Tenna-Boost can be used to operate up to 6 TV sets from one antenna. Works perfectly for black and white and color . . . plus FM and FM stereo.

There's a big difference in antenna amplifiers! Ask your distributor or write for technical bulletin.



Winegard
3013-4 Scotten, Burlington, Iowa

AMAZING TV LIFE-SAVER®

ONLY \$4.95 U.S. Pat. 2,914,637

Eliminates Costly TV Troubles
By absorbing damaging in-rush current so destructive to Television and Hi-Fi tubes, the TV LIFE-SAVER eliminates 3 out of 4 Service calls by more than tripling the life of all tubes . . .

PROTECTION



Model 4100-2, 100-275 watts 117 V. \$1.95 List
Model 8050-4, 250-400 watts 117 V. \$2.95 List

WUERTH SURGISTOR®
A new component easily installed to reduce call-backs by eliminating surge current damage to television and Hi-Fi tubes.

See your dealer or distributor today for these money saving, equipment saving Miracle Inventions. Or, send your order direct to us for prompt action.

WUERTH PRODUCTS CORP.
1949 Moffett St., Hollywood, Florida

new PATENTS

SPY RADIO DETECTOR

Patent No. 2,963,576

Oleg C. Enikeieff, Silver Springs, Md. (Assigned to Harry C. Miller Co., Rochester, N.Y.)

This device can detect hidden transmitters. Being untuned, it can pick up local radiation over a wide range of frequencies.

negative signal. It will reduce collector flow as indicated by meter M. V2 and D2 are not energized by the rf. They

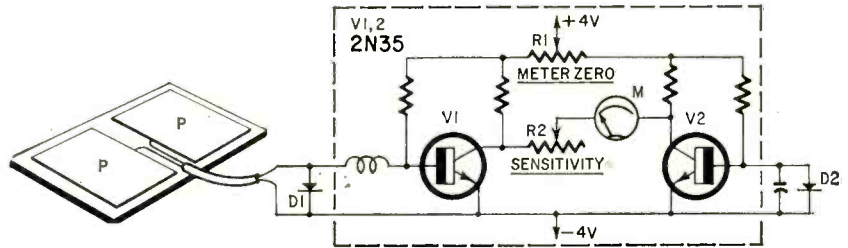

Two flat plates (P), 6 or 8 inches square, are etched or printed side by side on a panel. Radiation picked up by them is rectified by D1 and passed through an rf choke to V1 as a

are used only to balance out the meter current. Initially, and with no rf signal, R1 is adjusted for a meter zero. Resistor R2 controls the meter's sensitivity.

PRINTED-WIRING VARIABLE RESISTOR

Patent No. 2,970,244

Merritt L. Beverly, Torrance, Calif., and Manfred Kahn, Williamstown, Mass. (Assigned to Sprague Electric Co.)

The resistor (R) is shown on an assembly (Fig. 1). Fig. 2 shows details of the rotor and wiper.

metal wiper. It maintains pressure on a printed-circuit resistive coating (not shown) similar to that in a standard potentiometer.

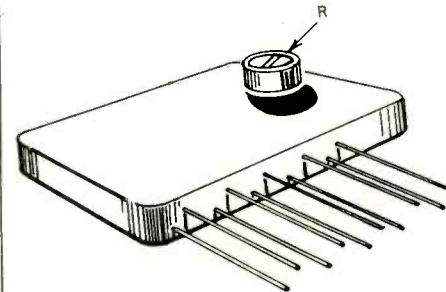

Fig. 1

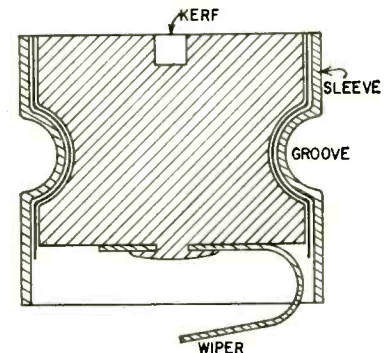

Fig. 2

MEASURING THIN METAL DEPOSITS

Patent No. 2,967,934

Pierre Pascal Martinelli, Paris, France. (Assigned to Commissariat a l'Energie Atomique)

The metal is bombarded by beta rays which cause it to give off X-rays. These are detected by a photomultiplier and indicated by a pulse counter (Fig. 1). The frequencies at which the X-rays peak are a characteristic of the particular metal. The intensity of radiation rises with the deposit thickness.

A screen eliminates any beta rays that might be present, while passing the X-rays. The filter (between amplifier and counter) is variable and may be set for the desired band. END

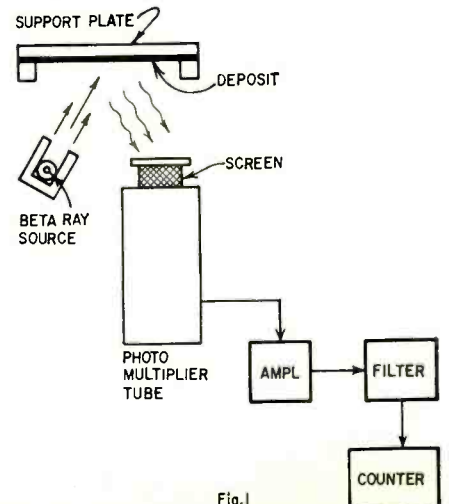
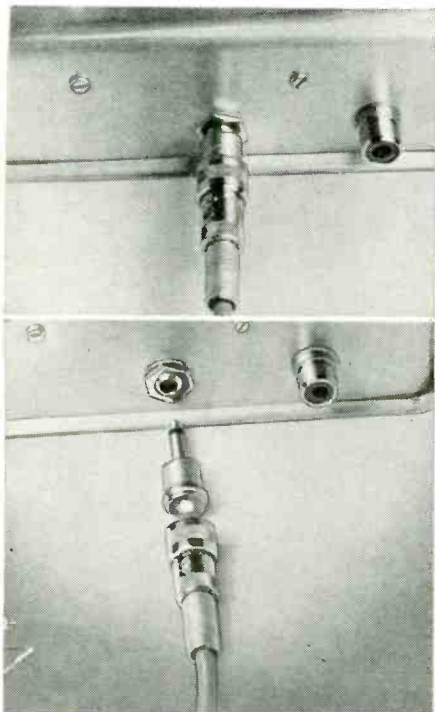

Fig. 1



CONNECTOR ADAPTER

This little adapter lets you connect a miniature mike connector to a miniature phone jack quickly. Remove the cable-protecting spring from a Switchcraft 5501M miniature mike connector, and saw off the connector to a length of about 1/2 inch. Take a short length of hookup wire and solder one end to the center lug of a miniature phone plug. Insert the threaded shank of the phone plug into the end of the mike connector, allowing the wire to pass through the connector and the eyelet.



Join the phone plug and mike connector securely with a couple drops of solder. Clip off the excess wire and solder the end into the eyelet in the mike connector. The photo shows the completed adapter all set to join a miniature phono jack to a mike connector.

A coupling ring slipped onto the adapter allows it to take either a female or male mike connector.—*Art Trauffer*

OIL ELECTRIC CLOCKS

In some clock radios the motor is a sealed unit. When it needs oiling, it becomes rather noisy. Oiling a motor inside a sealed case is a problem, but one that can be solved.

Remove the sealed unit and hold

Now... Tomorrow and for years to come!

Sonar CITIZENS BAND RADIO

- 8 Channels, crystal controlled transmitter and receiver
- Tunable receiver for 22 channels
- Transmitter 100% Class B modulated
- Adjustable squelch
- Automatic noise limiter
- R. F. Power indicator
- 1 Year guarantee
- Easy to install. Ideal for home, boat, car or business. Weighs only 9 lbs. . . 4 3/4 x 9 1/2 x 1 1/4
- FCC Type accepted*

*in preference to only certification

with 1 pair of crystals, microphone and power cables

\$179.50



Sonar
RADIO CORPORATION

73 Wortman Ave., Brooklyn 7, N.Y.

Please send me complete information on Model "E" CB Radio.

Dept. 110

NAME _____

ADDRESS _____

CITY _____

STATE _____

Please mention
RADIO-ELECTRONICS
when answering ads.

AUDIO unlimited
Specializes in **SAVING YOU MONEY**

- ✓ FACTORY FRESH COMPONENTS
- ✓ LOWEST POSSIBLE QUOTATIONS
- ✓ FAST DELIVERY

We are FRANCHISED DEALERS for most Hi-Fi lines. Most orders SHIPPED PROMPTLY from stock. RECORDING TAPE at LOWEST PRICES. FREE 95 page STEREO CATALOG

190-R Lex. Ave., Cor. 32 St., New York 16, N. Y. Visit Our Showroom

CASH FOR YOU-



Electric APPLIANCES

Learn at Home • \$3 to \$5 an Hour

Spare Time, Full Time • Be Your Own Boss
FREE BOOK tells about profitable business you can run—right at home. Repair Electric Appliances, using simple tools. Pays \$3-\$5 an hour!

CASH IN ON THIS BIG BOOM

400 MILLION Appliances are in American homes right now. People need them fixed. You make good money doing it. In your basement, garage, even your kitchen.

QUICK WAY TO GET STARTED

For less than 20¢ a day our easy, pictured instruction—backed by 45 years of success in home-training—prepares you for top earnings. Earl Reid of Thompson, Ohio, says: "Made \$510 in one month spare time." At no extra charge you get Appliance Tester, too. Finds trouble-spots, checks your work.

Get your FREE Book and FREE Sample Lesson! Mail coupon below, letter or postcard, now.

NATIONAL RADIO INSTITUTE, Appliance Div.
Dept. FD2, Washington 16, D. C.

Send Free Book, Free Appliance Repair Course Lesson. Am interested in:

Spare Time Earnings My Own Business
 Better Job

Name _____
Address _____
City _____ Zone _____ State _____

Accredited Member National Home Study Council

TAPE RECORDERS



HI-FI COMPONENTS
SLEEP LEARN KITS

Unusual Values
Free 1962
Catalog
DRESSNER

MERITAPE

Low cost, high quality recording tape, in boxes or cans.

1523RE Jericho Tpke, New Hyde Park, N.Y.

Fall Edition
"New 1962
Catalog"

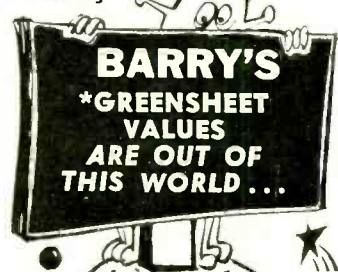

BARRY'S
*GREENSHEET
VALUES
ARE OUT OF
THIS WORLD ...

★ A complete catalog of specialized industrial Electronic TUBES and COMPONENTS featuring Barry Electronics savings to Industry, Servicemen and Experimenters.

RME-6900 Communications Receiver
(ELECTRO-VOICE) Fabulous Deal on Trade-in WRITE OR CALL

We'll also purchase your equipment and unused tubes. Send details:

BARRY ELECTRONICS

512 BROADWAY,
NEW YORK 12, N.Y.

11 YEARS OF BUYERS' CONFIDENCE

CORPORATION

WAiker 5-7000
AREA CODE 212
TWX: NY1-3731

Please send me a copy of the new 1962 *Greensheet and add my name to your mailing list.

(RE-4)

Name _____ Title _____

Company _____

Address _____

City _____ State _____

R-E**Classified****ADS**

Rates—50¢ per word (including name, address and initials. Minimum ad 10 words. Cash must accompany all ads except those placed by accredited agencies. Discount, 10% for 12 consecutive issues. Misleading or objectionable ads not accepted. Copy for June issue must reach us before April 12, 1962.

RADIO-ELECTRONICS, 154 West 14 St., New York 11, N. Y.

FOR SALE**Electronics**

INVESTIGATORS, write for free brochure on latest subminiature electronic listening devices. DEPT. 4C, 11500 NW 7th Ave. Miami 50, Fla.

INDUSTRIAL TUBES TYPE 5555 \$95.00—CRT 7MP7 \$10.00—ELC-6-A \$6.00 many others. Write your requirements SPERA ELECTRONICS 37-10 33 St., L.I.C., N.Y.

PRECISION RESISTORS, carbon-deposit. Guaranteed 1% accuracy. Millions in stock. ½ watt, 8¢. 1-watt, 12¢, 2-watt, 15¢. Leading manufacturers. ROCK DISTRIBUTING CO., 902 Corwin Rd., Rochester 10, N.Y.

TV TUNERS — rebuilt or exchanged, shipped same day received \$9.95. WESTERN TUNER REBUILDERS, 4130 El Cajon Blvd., San Diego 5, Calif.; 3040 Sunset Blvd., Los Angeles, Calif.

SHORT CIRCUITS pinpointed within 5 feet or your \$4.50 back. Own a patented pocket-size Dynamic Short Locator. DYNAMICO, 11370 SW 60th Terr., Miami 43, Fla.

SCHEMATICS, repair information. Television \$1.50. Radio 75¢. Send make and model. SCHEMATICS UNLIMITED, Box 65, Flushing 64, N.Y.

SCHEMATIC DIAGRAMS, exact replacement parts orders: Japanese transistor or tube radios, recorders, transceivers, electronics equipment. Give model and manufacturer, \$1.00. TECHSERVICES, CPO 849, Tokyo, Japan.

DOOR OPERATORS, \$59.95. Automatic chain drive. Not a kit—highest quality. Free Literature. DEMSCO, Sebring 25, Ohio.

SUPERSENSITIVE directional microphone picks up a whisper at great distances. Used by investigators to record faint, distant sounds without being detected. Easily constructed for about \$7. Step-by-step plans, \$1.95. DEE CO., Box 7263-A, Houston 8, Tex.

PROFESSIONAL ELECTRONIC PROJECTS—Organs, Timers, Computers, etc.—\$1 each. List free. PARKS, Box 1665, Lake City, Seattle 55, Wash.

BEFORE YOU BUY Receiving Tubes or Hi-Fi Components send now for your giant FREE Zalytron current catalog—featuring nationally known Zalytron First Quality TV-Radio Tubes, Hi-Fi Stereo Systems, Kits, Parts, etc. All priced to Save You Plenty—Why Pay More? ZALYTRON TUBE CORP., 220 W. 42nd St., N.Y.C.

CONVERT ANY TELEVISION to sensitive big-screen oscilloscope. Only minor changes necessary. Plans \$1.95. RELCO, Box 10563-D, Houston 18, Tex.

ELECTRONIC SURPLUS CATALOG, 5,000 items. Send 10¢. BILL SLEP CO., Drawer 178R, Ellenton, Fla.

SAVE DOLLARS on Radio, TV Tubes. Brand new. Parts at less than manufacturer's cost. 100% Guaranteed. No rebrands or pulls! Request bargain bulletin. UNITED RADIO, Box 1000-R, Newark, N.J.

DIAGRAMS FOR REPAIRING RADIOS, \$1; television \$2. Give make and model. DIAGRAM SERVICE, Box 672 RE, Hartford 1, Conn.

DIAGRAMS for TV, \$2.00; for radio, \$1.00. HIETT DIAGRAMS, Box 816, Laredo, Tex.

DIAGRAMS: Television \$1.25, Radio \$.50. MISC. SALES, 129 Cooper, Santa Ana, Calif.

SAVE Time, Save Money. Kits. WIRING SERVICE, 46A Cedar St. Waltham, Mass.

FREE BRAND-NEW FAMOUS-BRAND TUBES. Catalog discounts to 75% from list. Picture tubes at 75¢ inch up; parts, kits at 1/10 original cost. Phono needles, tube testers, silicones, seleniums, 7" TV bench test tube—\$6.99—and more. ARCTURUS ELECTRONICS CORP. RE, 502 22nd St., Union City, N.J.

ELECTRIC MOTOR REPAIRING SIMPLIFIED! Details Free! MODERN—Box 8715, Kansas City 14, Mo.

MODEL 80 Signal Generator, \$250; Model 82 \$200. 150mc packsets as low as \$20. Write CDI, Box 9545, St. Petersburg 40, Fla.

SMALL SET BUILDER'S big information catalogue—25¢, refundable. LABORATORIES, 1131-B Valota, Redwood City, Calif.

PRINTED CIRCUITS. Free catalog lists hundreds of circuits. CLOUD "9" ENGINEERING, Brookdale, Calif.

Audio—Hi-fi

COMPONENTS, Recorders, Tapes. FREE Wholesale Catalogue. CARSTON, 125-T East 88th St., New York 28, N.Y.

DON'T BUY HI-FI COMPONENTS. Kits, Tape, Tape Recorders until you get our low, low return mail quotes. "We Guarantee Not To Be Undersold." Wholesale Catalog Free. Easy Time Payments Plan, 10% down—up to 24 months to pay. HI-FIDELITY CENTER, 220 RC E 23 St., New York 10, N.Y.

TAPE recorders, Hi-Fi components, Sleep-learning equipment, Tapes, Unusual values. Free catalog. DRESSNER, 1523R Jericho Turnpike, New Hyde Park, N.Y.

HI-FI AMPLIFIERS, TUNERS, SPEAKERS, WALKIE-TALKIES, Radios, Telescopes, Microscopes, Cameras, low prices. Free Catalog. GM PHOTOELECTRONICS, 623 Gay St., Knoxville 2, Tenn.

SAVE 30%. Stereophonic music on tape. Request tape, recorder Catalog R-1. SAXITONE TAPE SALES, 1776 Columbia Rd, Washington 9, D.C.

RENT STEREO TAPES—over 2,500 different—all major labels—free catalog. STEREO-PARTI, 811-RE, Centinela Ave., Inglewood 3, Calif.

SALE ITEMS. Component quotes. Bulk tapes. BAYLA CO., Box 131-RE, Wantagh, N.Y.

GARRARD Model A and a Dual 1006 or Miracord Studio record changer, Pickering 380C, Empire 108, Shure M7D or Miracord cartridge. Any changer cartridge combination \$64.50. Any three cartridges \$34.50, 25% deposit, balance COD. PROFESSIONAL HI FI, 248-52 Jericho Turnpike, Bellerose, N.Y.

General

FREE GIANT WHOLESALE CATALOG, Electronics, HiFi, Tools, Tubes, Radios, Imports Housewares, Photo's, optics, appliances, survival products. Write LEKTORN 241 Everett Ave., Chelsea, Mass.

PLEXIGLAS: Send for price list TECHNICAL STOREROOM, Dept. 234, P.O. Box 7711, Orlando, Fla.

U. S. GOVERNMENT SURPLUS—Jeeps, \$264.00, Radios \$2.53, Guns, Typewriters, Cameras, Tools; thousands of items. Fabulously low surplus prices. Complete information sent immediately. Send \$1.00 to: SURPLUS, P.O. Box 512-NN, New Orleans 1, La.

BUSINESS AIDS

500 PRINTED GUMMED Name and Address Labels, \$1.00. No COD's. Print clearly. ADDISON MAIL ORDER, RE-8, 1840 Addison, Chicago 13, Ill.

RUBBER STAMPS—name, address, \$1.00. 1,000 Business Cards, \$3.99. Free catalog. ALCO, Box 244-R, Urbana, Ill.

BUSINESS CARDS, LABELS, RUBBER STAMPS. Send for free descriptive literature. HEIGHTS INDUSTRIES, Capitol Heights 27, Md.

LETTERHEADS — Billheads — Envelopes — Statements. Super special. Free details. OKAYPRINTER, Martins Ferry, Ohio.

EDUCATION/INSTRUCTION

HOW TO ADAPT CHORDS for Popular Music on all instruments, at sight, \$1.25. WALTER KAZAKS, 234 East 58th St. New York 22, N.Y.

SLEEP LEARNING. Startling method 92% effective. Brochure free. ASR FOUNDATION, Box 21RE, Henry Clay Station, Lexington, Ky.

it over a 100-watt bulb for a few minutes. Now put a few drops of fine oil on and around the gear section. Soon bubbles will appear as the heat drives the air out of the sealed case. Then turn off the lamp. As the unit cools, the oil will be drawn inside to the motor. Repeat this several times. Now the motor will run noiselessly.—A. von Zook

HANDY SNOOT

To give that bottle of tape recorder cleaning solvent a long handy snout, just insert a pipe cleaner into the applicator lid. Not only does this make



application easier, the pipe cleaner lets you brush away dust and dirt too.—Chester A. Clifford

AUTOSWITCH FOR AUDIO SYSTEM

The diagram shows an autoswitch circuit I have been using for several years. It requires no relay, unlike many such systems. Instead, all I use is a

dpdt switch wired so that it transfers the amplifier transformer primary from

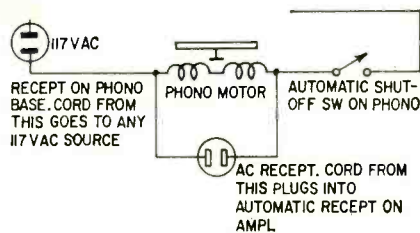

Fig. 1

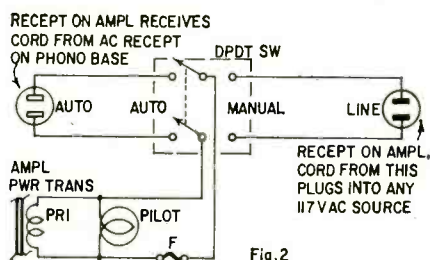

Fig. 2

manual operation (used when the program source is a tuner) to automatic operation (when records are being played).—Maxwell E. Lait

BAD TUBES SOMETIMES GOOD

Ordinary tube checkers are usually pretty accurate when it comes to detecting open filaments, low emission, internal shorts and gas. But the readings they give are not always conclusive evidence that a given tube is bad for all circuits. An ordinary tube checker cannot subject a given tube to all of its operational conditions. So the average

service technician resorts to the substitution method as the most reliable test.

That is not always accurate either. Many times I have found tubes which would not work in one circuit will work very satisfactory in another. Instead of discarding these doubtful tubes, I save them for installation in circuits where they can be used. I label the doubtful ones to avoid unnecessary confusion.—John A. Comstock

STOVE PAD SIMPLIFIES SOLDERING

Don't leave burned benches behind you after soldering jobs. Borrow a stove burner pad from the kitchen. A round asbestos pad like the one pictured is cheap protection against hot

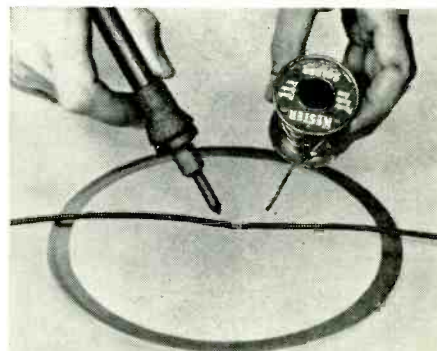

iron or gun scarred bench tops. The pad also acts as a good catch-all for drops of hot solder and wire clippings.—John A. Comstock END

LEARN WHILE ASLEEP, Hypnotize with your recorder, phonograph or amazing new Electronic Educator endless tape recorder. Catalog, details free. SLEEP-LEARNING ASSOCIATION, Box 24-RD, Olympia, Wash.

NEW CONCEPT OF LEARNING SELF-HYPNOSIS! Now on tape or record! Free Literature. MCKINLEY-SMITH CO., Dept. T5, Box 3038, San Bernardino, Calif.

BACCALAUREATE Degree Correspondence Course Directory: \$2.00. COLLEGE RESEARCH, North Highlands 14, Calif.

WANTED

CASH PAID! Sell your surplus electronic tubes. Want unused, clean radio and TV receiving, transmitting, special purpose, Magnetrons, Klystrons, broadcast types, etc. Want military & commercial lab/test and communications equipment such as G.R., H.P., AN/UPM prefix. Also want commercial receivers and transmitters. For a fair deal write BARRY, 512 Broadway, New York 12, N. Y. Walker 5-7000.

G-R, H-P, L&N, etc.; tubes, manuals, military electronics. ENGINEERING ASSOCIATES, 434 Patterson Road, Dayton 19, Ohio.

WANTED: Tubes, Diodes, Transistors, Military, Commercial Lab-Grade Test Equipment, Components, PRC, GRC Equipment, Aircraft Equipment by Collins. TOP PRICES. Write details, Bob Sanett, W6REX, V & H RADIO & ELECTRONICS, 2053 Venice Blvd., Los Angeles 6, Calif.

SERVICES

FREE CATALOG: Parts, Equipment, meter — equipment repairs, BIGELOW ELECTRONICS, Bluffton, Ohio.

TV TUNERS—rebuilt or exchanged, \$9.95 complete—all types—fast, guaranteed service. Send tuner with all parts to: L. A. TUNER EXCHANGE, 4611 W. Jefferson Blvd., Los Angeles 16, Calif.

TRANSISTORIZED products dealers catalog, \$1. INTERMARKET, CPO 1717, Tokyo, Japan.

ALL MAKES OF ELECTRICAL INSTRUMENTS AND TESTING equipment repaired. New and used instruments bought, sold, exchanged. HAZELTON INSTRUMENT CO., 128 Liberty St., New York, N.Y.

PATENTS—INVENTIONS. U.S. Patent Office searches. Patent development of electronic, electrical and electromechanical inventions. Send for Free Protection "Invention Certificates" and "Invention Information." GEORGE SPECTOR, Licensed professional patent engineer; U.S. Patent Office former examiner, 3615 Woolworth Bldg, 233 Broadway, N.Y.

MISCELLANEOUS

GIANT ARMS. Dr. Young's D. C. Revolutionary discovery. \$2.00 Satisfaction or refund. GAUCHO, Box 9309-X5, Chicago 90, Ill.

MODEL RELEASES, Forms 100—\$1.00. STUDIO, Box 1143-F, Santa Barbara, Calif.

INDEPENDENT THINKERS—investigate Humanism! Free literature. AMERICAN HUMANIST ASSOCIATION, Dept. REL, Yellow Springs, Ohio.

PRINTING PRESSES, type, supplies. List 4¢. TURNBAUGH SERVICE, Mechanicsburg, Pa.

BUY/RENT COMEDY, PARTY RECORDS. Sampler and catalogs, \$1.00. DRC, Dept. RE-4, 11024 Magnolia Blvd., No. Hollywood, Calif.

100 DIFFERENT United States commemorative stamps. ½¢ to 10¢ face, used \$1.00; mint, \$4.95. IRWIN, Box 12D, Brooklyn 29, N.Y.

PROTECT YOUR TUBE CADDIES AND TEST EQUIPMENT while in your car or truck with a Melco Siren Alarm System. This inexpensive system which you can install yourself costs only \$34.95 complete. Literature on request. ROTO CO., Box 8434, Chicago 80, Ill.

BOOK 200 Electric Stunts \$1.00. CUTT-RADO, 875 Arastradero, Palo Alto, Calif.

BUILD 10-25 RADIO CIRCUITS AT HOME

with the New
PROGRESSIVE RADIO "EDU-KIT"®

only
\$14.95
up
Reg. U.S.
Pat. Off.

ALL Guaranteed to Work!

A Complete Home Radio Course

- BUILD**
- Receivers
 - Transmitters
 - Signal Tracers
 - Signal Injector
 - Code Oscillator
 - Sq. Wave Generator
 - Amplifier
- No Knowledge of Radio Necessary
• No Additional Parts or Tools Needed
• Excellent Background for TV



WHAT THE "EDU-KIT" OFFERS YOU

The "Edu-Kit" offers you an outstanding PRACTICAL HOME RADIO COURSE at a rock-bottom price. You will learn radio theory, construction and servicing. You will learn how to build radios, using regular schematics; how to solder and wire in a professional manner; how to service and trouble-shoot radios. You will learn how to work with punch and metal chassis as well as the new Printed Circuit chassis. You will learn the principles of RF and AF amplifiers and oscillators, detectors, rectifiers, test equipment. You will learn and practice code, using the Progressive Code Oscillator. In brief, you will receive a basic education in Electronics and Radio, worth many times the small price you pay.

PROGRESSIVE TEACHING METHOD

The Progressive Radio "Edu-Kit" is the foremost educational radio kit in the world, and is universally accepted as the standard in the field of electronics training. The "Edu-Kit" uses the modern educational principle of "Learn by Doing." You begin by building a simple radio. Gradually, in a progressive manner, and at your own rate, you construct more advanced multi-tube radio circuits, learn more advanced theory and techniques, and do work like a professional radio technician. These circuits operate on your regular AC or DC house current.

THE KIT FOR EVERYONE

You do not need the slightest background in radio or science. The "Edu-Kit" is used by young and old, schools and clubs. By Armed Forces Personnel and Veterans Administration for training and rehabilitation.

One of the most important aspects of the "Edu-Kit" is the Consultation Service which we provide. We welcome students to send us their problems, which are related to any of the material covered in the "Edu-Kit" course, or encountered in other experiences in the field of electronics.

THE "EDU-KIT" IS COMPLETE

You will receive all parts and instructions necessary to build several different radio and electronic circuits, each guaranteed to operate. Our kits contain tubes, tube sockets, variable, electrolytic, mica, ceramic and paper dielectric condensers, resistors, tie strips, coils, hardware, tuning, punched metal chassis, Instruction Manuals, hook-up wire, solder, selenium rectifiers, volume controls, switches, etc. In addition, you receive Printed Circuit materials, including Printed Circuit Chassis, special tube sockets, hardware and Instructions. You also receive a useful set of tools, pliers, cutters, an alignment tool, professional electric soldering iron, wrench set, and self-powered, dynamic Radio and Electronics Tester. The "Edu-Kit" also includes Code Instructions and the Progressive Code Oscillator. You will also receive lessons for servicing with the Progressive Signal Tracer and the Progressive Signal Injector, a High Fidelity Guide, FCC Amateur License Training Book, and a Quiz Book.

TROUBLE-SHOOTING LESSONS

You will learn to trouble-shoot and service radios, using the professional Signal Tracer, the unique Signal Injector and the dynamic Radio and Electronics Tester. Our Consultation Service will help you with any technical problems.

FREE EXTRAS

- Set of Tools • Radio Book • Radio and Electronics Tester • Electric Soldering Iron • Pliers-Cutters • Alignment Tool • Test Rigging Book • Hi-Fi Book • TV Book • Quiz Book • Membership in Radio-TV Club; Consultation Service • FCC Amateur License Training • Printed Circuitry Certificate of Merit • Valuable Discount Card • Wrench Set

Choose From These Popular "Edu-Kit" Models

- #10A: 10 Circuits \$14.95
- #15A: 15 Circuits \$19.95
- #16A: 16 Circuits (Includes Printed Circuitry) \$22.95
- #20A: 20 Circuits (includes Printed Circuitry and 4 Advanced Circuits) \$29.95
- #25A: 25 Circuits (includes Printed Circuitry and 9 Advanced Circuits) \$30.95

UNCONDITIONAL MONEY-BACK GUARANTEE

Please RUSH my Progressive Radio "Edu-Kit" to me. BE SURE TO INCLUDE all the FREE EXTRAS and BONUS RESISTOR and CONDENSER KITS WORTH \$7.00.

- MODEL desired _____ Price _____
- Send "Edu-Kit" postpaid. I enclose remittance in full.
- Send "Edu-Kit" C.O.D. I will pay postage.
- Send me FREE additional information describing "Edu-Kits."

Name _____
Address _____

Progressive "EDU-KITS" Inc.

1186 Broadway Dept. 196G Hewlett, N.Y.



TRANSISTORS, by Dr. Wolfgang W. Gartner. *D. Van Nostrand Co., Inc., 120 Alexander St., Princeton, N. J. 6 x 9 in. 675 pp. \$12.50.*

A detailed course in principles and applications, with numerical examples, typical diagrams and examples of circuit design.

FUNCTIONAL CIRCUITS AND OSCILLATORS, by Herbert J. Reich. *D. Van Nostrand Co., Inc., 120 Alexander St., Princeton, N.J. 6 x 9 in., 466 pp. \$12.50.*

A comprehensive text on a variety of topics including sine-wave oscillators, negative-resistance circuits, gates, counters, etc., with numerous diagrams and problems.

101 KEY TROUBLESHOOTING WAVEFORMS FOR VERTICAL-SWEEP CIRCUITS and 101 KEY TROUBLESHOOTING WAVEFORMS FOR HORIZONTAL-SWEEP CIRCUITS, both by Robert G. Middleton. *Howard W. Sams & Co. Inc., 1726 E. 38 St., Indianapolis, Ind. 125 pp. 5 1/2 x 8 1/2 in. \$2.00 each.*

Each volume illustrates and explains distorted waveforms (and what causes them) obtained from defective sweep systems. All are arranged for quick diagnosis and analysis.

TUBE AND TRANSISTOR HANDBOOK. *De Muiderkring N. V., Bussum, Netherlands. 4 1/2 x 8 1/2 in. 401 pp. \$4.00.*

A pictorial type of handbook, with specifications actually shown on the tube basing diagram. Introductions in many languages; pictorial sections and tables all in English.

BASIC RADIO COURSE, by John T. Frye. *Gernsback Library, Inc., 154 W. 14 St., New York, N. Y. 5 1/2 x 8 1/2 in. 224 pp. \$4.10.*

A completely revised edition of the original work. Fifty-page increase in size includes transistor radio circuits. A series of questions has been added at the end of each chapter.

GUIDE TO SHORT WAVE LISTENING, by O. Lund Johansen. Available from Gilfer Associates, Box 239, Park Ridge, N. J., 6 x 8 in. 140 pp. \$2.

A companion book to "The World Radio Handbook." Tells how to listen to the world and to satellites from outer space. Especially useful to the newcomer to shortwave listening.

ELECTRONICS MATH SIMPLIFIED, by Alan Andrews. *Howard W. Sams & Co. Inc., 1720 E. 38 St., Indianapolis, Ind. 5 1/2 x 8 1/2 in. 224 pp. \$4.95.*

Text and practical examples show how to use basic algebra, logs and trig tables in solving problems relating to dc and ac circuits, antennas, amplifiers, etc.

SERVICING TV REMOTE CONTROLS, by Samuel L. Marshall. *Howard W. Sams & Co. Inc., 1720 E. 38 St., Indianapolis 6, Indiana. 5 1/2 x 8 1/2 in. 159 pp. \$2.95.*

This guide explains various systems, from simple to complex; tells how to install, troubleshoot and align.

TELEVISION AND RADIO REPAIRING (Second Edition), by John Markus. *McGraw-Hill Book Co., 330 W. 42 St., New York 36, N. Y. 6 x 9 in. 576 pp. \$8.95.*

A home-study guide that assumes no previous radio-TV knowledge, but shows how to use tools and test equipment to replace parts and repair sets.

PHOTOELECTRETS AND THE ELECTRO-PHOTOGRAPHIC PROCESS, by V. M. Fridkin and I. S. Zheludev. *Consultants Bureau Enterprises Inc., 227 W. 17 St., New York 11, N. Y. 6 x 9 in. 180 pp. \$12.50.*

An electret (piece of dielectric material with a permanent positive charge on one face and a permanent negative charge on the other) is traditionally produced by cooling the melted dielectric substance in a powerful electric field. A more recent method consists of subjecting the dielectric to strong illumination in an electric field. This book describes electrets made by that process, discusses interesting equipment for measuring the charge, possible uses in photography and theories underlying the photoelectret phenomenon. A bibliography of some 140 references is given.

HI-FI STEREO HANDBOOK (Second edition), by William F. Boyce. *Howard W. Sams & Co. Inc., 1720 E. 38 St., Indianapolis, Ind. 5 1/2 x 8 1/2 in. 288 pp. \$3.95.*

A guide to the planning, selection and installation of hi-fi systems and components, and an explanation of audio theory.

ANALYTICAL TECHNIQUES FOR NON-LINEAR CONTROL SYSTEMS, by John C. West. *D. Van Nostrand Co. Inc., 120 Alexander St., Princeton, N. J. 5 1/2 x 8 1/2 in. 223 pp. \$5.75.*

Modern theory and methods are explained for researchers and advanced students.

RCA RECEIVING TUBE MANUAL RC-21, *Electron Tube Div., RCA, Harrison, N. J. 8 1/4 x 5 3/8 in. 480 pp. \$1.*

The new *Receiving Tube Manual* has gone up to 480 pages, describes over 900 receiving tubes. The Circuits Section has also been expanded, and now includes 26 circuits.

TWO-WAY MOBILE RADIO MAINTENANCE by Jack Darr. *Howard W. Sams & Co. Inc., 1720 E. 38 St., Indianapolis 6, Ind. 5 1/2 x 8 1/2 in. 255 pp. \$4.95.*

This book contains valuable information, service hints and test procedures, for technicians who hold at least a Second-Class radiotelephone license.

EFFECTS OF NUCLEAR RADIATION ON MEN AND MATERIALS, by T. C. Helvey. *John F. Rider, Publisher Inc., 116 W. 14th St., New York 11, N.Y. 5 1/2 x 8 1/2 in. 56 pp. \$1.80.*

Starting with fundamentals, this book explains radiation and describes in clear language its effects. **END**

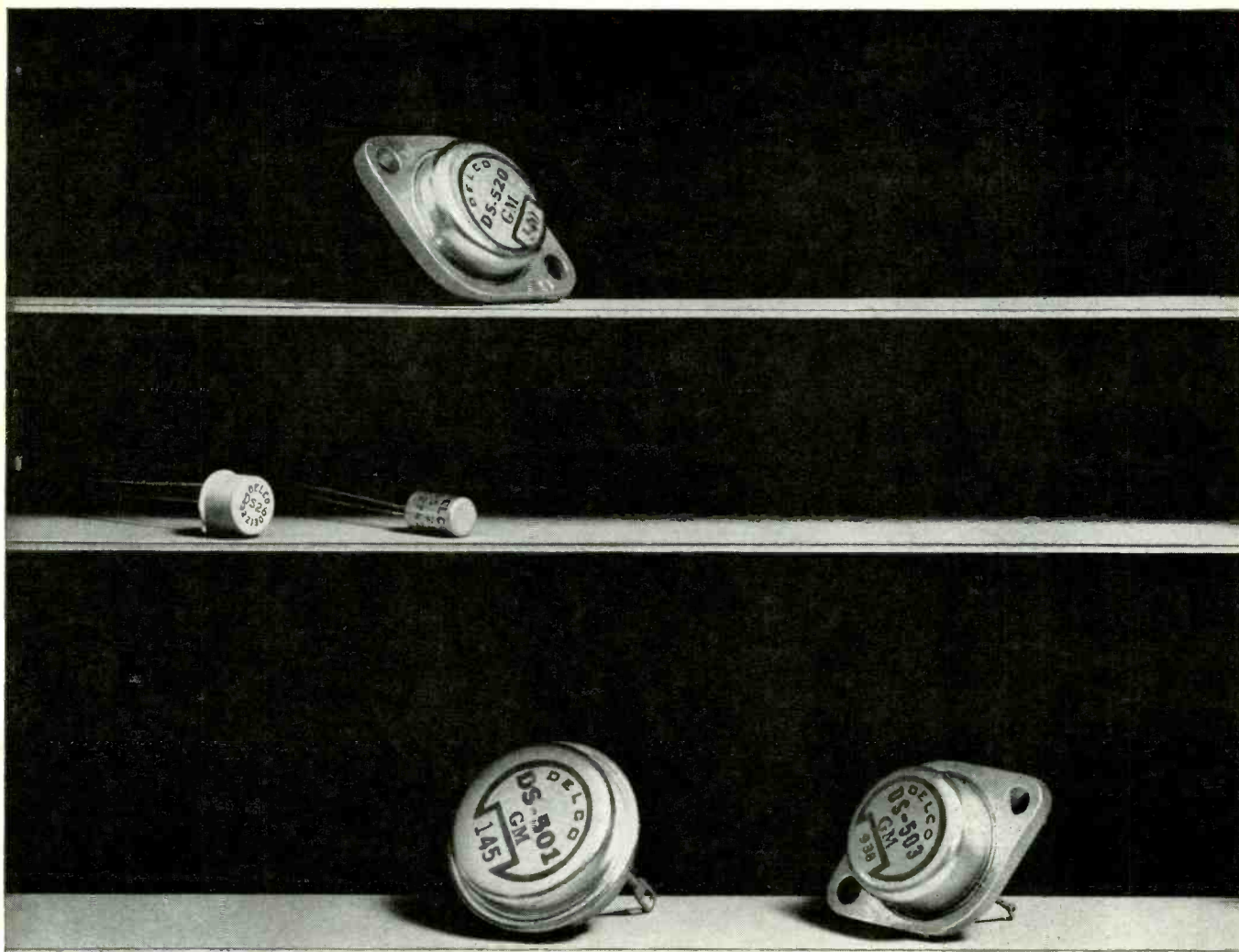

**YOU'RE LOOKING AT ALL THE TRANSISTOR INVENTORY YOU NEED
TO SERVICE EVERY TRANSISTOR CAR RADIO ON THE ROAD!**

simply say **Delco**

There are millions of transistors in car radios today . . . and with just five Delco numbers in stock, you're ready to service this entire replacement market. Simply say Delco and get these advantages!

- Five transistor numbers service all PNP Transistor Auto Radios!
- Delco's DS-25 and DS-26 cover small signal transistor needs in all Delco radios!
- Delco's DS-501 and DS-503 cover audio output transistor needs in all Delco radios!
- Delco's DS-520 fits all non-Delco radios—actually improves performance (up to 1.5 watts)!
- DS-25 and DS-26 replace practically every PNP transistor used in *portable* radios!
- Application and cross reference charts are packaged with your Delco transistors!
- All these advantages are yours at a low cost!

Cash in now on the coverage you get from top-quality **Delco Radio** Automotive Radio Service Parts and Electro-Mechanical devices, distributed nationally through **United Delco**.

DELCO RADIO, Division of General Motors, Kokomo, Indiana



School Directory

LEARN
RADAR MICROWAVES
COMPUTERS—TRANSMITTERS
CODE • TV • RADIO

Phila. Wireless Technical Inst.
1533 Pine St., Philadelphia 2, Pa.
A Non-Profit Corp.
Founded in 1908
Write for Free Catalog to Dept. RE-4
Classes now forming

ENGINEERING DEGREES

E. E.
Option Electronics,
Mechanical,
Also in Liberal Arts
earned by
HOME STUDY
Resident Classes Also
Available if Desired
Specify course preferred

PACIFIC INTERNATIONAL COLLEGE OF ARTS & SCIENCES
Primarily a correspondence school
Chartered 1935

5719-M Santa Monica Blvd. Hollywood 38, Calif.

GET YOUR FIRST CLASS F.C.C. LICENSE IN HOLLYWOOD IN SIX WEEKS!

We are specialists in F.C.C. license preparation—we do nothing else. We prepare you for your first class commercial license in six weeks, through intensive full-time teaching and coaching. Our classes are small and meet for 8 hours a day, with maximum personal instruction by a superior teacher. One low tuition covers everything until your F.C.C. license is secured. Write for free details.

Pathfinder School, Dept. C-24
Suite 216
5504 Hollywood Blvd., Hollywood 28, Calif.

GET IN ON THE GROUND FLOOR IN ELECTRONICS!

Demand for trained men in every phase of electronics and radio-TV has never been higher. And new opportunities are opening up so fast that you can still get in on the ground floor. But only if you act now.

To prove how I.C.S. can help you break into this big money-making field, we'd like to send you—FREE—the famous I.C.S. Electronic Career Kit. There are 3 valuable booklets in this kit—guaranteed to open your eyes to opportunity, and show you how easily you can take advantage of it! But don't delay. This could be your chance of a lifetime! Mail the coupon today.

INTERNATIONAL CORRESPONDENCE SCHOOLS

Dean's Office, Z3420C, Scranton 15, Pa.
Please rush me FREE Career Kit. My field of interest is:

<input type="checkbox"/> FCC Lic., TV-Radio Engrg.	<input type="checkbox"/> Electrical Engrg.
<input type="checkbox"/> Electronic Technician	<input type="checkbox"/> Electrical Technician
<input type="checkbox"/> Electronic Computers	<input type="checkbox"/> Practical Electrician
<input type="checkbox"/> Stereo and Hi Fi	<input type="checkbox"/> Profess'l Engrg. (Elec.)
<input type="checkbox"/> Automation Electronics	<input type="checkbox"/> Electrical Drafting
<input type="checkbox"/> TV-Radio Servicing	<input type="checkbox"/> Other

Name _____ Age _____
Address _____
City _____ Zone _____ State _____

**ENGINEERING EDUCATION
for the Space Age**

NORTHROP INSTITUTE of Technology
is a privately endowed, nonprofit college of engineering offering a complete Bachelor of Science Degree Program and TWO-YEAR accredited technical institute curricula. Students from 50 states, many foreign countries. Outstandingly successful graduates employed in aeronautics, electronics, and space technology. Write today for catalog—no obligation.

NORTHROP INSTITUTE OF TECHNOLOGY
1181 West Arbor Vitae Street, Inglewood 1, California

ETI Engineering Technician
A.S. Degree—2 Years
Electronics Engineer
B.S. Degree—4 Years
Write for Folder

ELECTRONIC TECHNICAL INSTITUTE
970 West Manchester Ave., Inglewood, Calif.
4863 El Cajon Blvd., San Diego, Calif.

learn more . . . earn more
Become an Electronics Engineer. Major corporations regularly interview and employ seniors. **B.S. DEGREE IN 27 MONTHS** in Engineering. **IN 36 MONTHS** in Business Administration. Well-equipped labs. Small classes. **Low costs.** Enter June, Sept., Jan., Mar. Write **J. G. McCarthy for Catalog and Career Book.**

TRI-STATE COLLEGE
2442 College Avenue • Angola, Indiana

B. S. DEGREE IN 36 MONTHS
INDUSTRY & GOVERNMENT NEED
50,000 NEW ENGINEERS A YEAR!
Accelerated year-round program puts you in the job-market a whole year early! Also B.E. degree in 27 mos. Aero., Chemical, Civil, Electrical, Mechanical, Electronics, Math, Chemistry, Physics. Quality instruction; widely recognized. Graduates employed from coast to coast. Self-help program. Modest rate. Start Mar., June, July, Sept., Jan. Catalog: 15-12 E. Washington Blvd., Ft. Wayne 2, Ind.

INDIANA TECHNICAL COLLEGE

**GET INTO
ELECTRONICS**

V.T.I. training leads to success as technicians, field engineers, specialists in communications, guided missiles, computers, radar and automation. Basic & advanced courses in theory & laboratory. Electronic Engineering Technology an ECPD accredited Technical Institute curriculum. Assoc. degree in 29 mos. B.S. also obtainable. G.I. approved. Graduates in all branches of electronics with major companies. Start Sept., Feb., Dorms, campus. High school graduate or equivalent. Catalog.

VALPARAISO TECHNICAL INSTITUTE
Dept. C Valparaiso, Indiana

LEARN ELECTRONIC ORGAN SERVICING

This new, high paying profession can now be learned easily in your spare time.

- ★ Complete Training — All Makes and Models
- ★ Scientific Teaching Aids Make Learning Easy
- ★ No Prior Knowledge of Electronics Necessary

GET FULL DETAILS ON THIS AMAZING COURSE

WRITE FOR FREE BOOKLET

NILES BRYANT SCHOOL
Dept. L, 3731 Stockton Blvd.
Sacramento 20, California

Learn Mathematics

Today, to get ahead as a technical man, you must understand basic mathematics—logarithms, slide rule, algebraic notation and laws, algebraic functions, linear equations, quadratic equations, higher degree equations, applied geometry, applied trigonometry, progressions and series, transcendental equations, empirical equations, etc.

Grantham School has just recently developed an unusual home study course which can bring you up to date in these subjects.

Don't let inadequacy in math hold you back. Write for details today.

GRANTHAM SCHOOLS, INC.
ENGINEERING DIVISION
1505 N. Western Ave. Los Angeles 27, Calif.

ADVERTISING INDEX

Radio-Electronics does not assume responsibility for any errors appearing in the index below.

Aerovox Corp.	16
Allied Radio	9, 23
Atlas Sound Corp.	24
Audio Unlimited	105
Audion	97
B & K Manufacturing Co.	25
Barry Electronics Corp.	105
Bell Telephone Labs.	10
Bonder-Tongue Labs.	20
Brooks Radio & TV Corp.	94
Burstein-Applebee Co.	95
Cabinart Acoustical Engineering Corp.	76
Capitol Radio Engineering Institute	17
Carston	101
Centralab Div. of Globe-Union	22
Central Technical Institute	87-88
Claroat Manufacturing Co., Inc.	14
CLASSIFIED ADS	106-107
Cleveland Institute of Electronics	103
Commissioned Electronics Co.	102
Coyne Book Publishing Div.	103
Deico Div. of General Motors	109
DeVry Technical Institute	7
Dressner	105
Electronic Chemical Corp.	96
Electronic Instrument Co. (EICO)	30
Electronic Market	102
Electronic Measurement Corp. (EMC)	26
Electronic Publishing Co. Inc.	100
Fair Radio Sales	97
Fisher Radio Corp.	92
GM Photoelectronics	101
Geinback Laboratories, Inc.	101
Grantham School of Electronics	15
Gregory Electronics Corp.	97
Harman-Kardon Inc.	28
Heald's Engineering College	98
Health Company	62-63
Heller Roberts Instrument Corp.	84
Holt, Rinehart & Winston Inc.	79
Indiana Technical College	95
International Crystal Mfg. Co. Inc.	112
E. F. Johnson Co.	98
Key Electronics Co.	100
Lafayette Radio	69
Mallory Co. Inc. (P.R.)	29
Moss Electronic Inc.	98
Muelier Electric Co.	96
National Radio Institute	27-28, 93, 105
National Technical School	5
North American Philips Co. Inc.	24
Picture Tube Outlet	102
Progressive Edu-Kits Inc.	108
RCA Electron Tube Div.	Back Cover
RCA Institutes	77-78
Rad-Tel Tube Co.	111
RTS Electronics Div.	13
Sams (Howard W.) & Co., Inc.	19, 90
Schober Organ Co.	71
Scout (H. H.) Inc.	3
Sencore	67
Sonar Radio Corp.	105
Sonotone Corp.	8
Sony Corp. of America	65
Sprague	18
Standard Kollsman Industries Inc.	3rd Cover
Switchcraft Inc.	84
T A B	97
Tarzian (Sarkes) Inc.	81
Technical Appliance Corp. (TACO)	91
Transvision	100-101
Triplet Electrical Instrument Co.	2nd Cover
Tung-Sol Electric Inc.	70
Turner Company	83
Utah Electronics Corp.	12
Vaco Products Co.	99
Warren Electronics Co.	101
Winegard Co.	104
Wuerth Products Corp.	104
Zenith Radio Corp.	72-73

SCHOOL DIRECTORY PAGE 110

Niles Bryant School
Grantham School of Electronics
Electronic Technical Institute
Indiana Technical College
International Correspondence School
Northrop Institute of Technology
Pacific International College of Arts & Sciences
Pathfinder School
Phila. Wireless Technical Institute
Tri-State College
Valparaiso Technical Institute
Printed in USA

Buy Your Tubes Direct...from RAD-TEL

The Leading "DIRECT-BY-MAIL" Tube Company

up to 75% OFF...RAD-TEL'S Quality Brand-New Tubes

1-Year Guarantee—One-Day Service—Over 500 Types in Stock

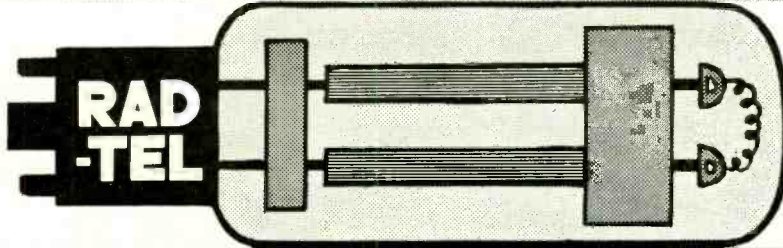

FREE!

- Send For New Tube & Parts Catalog
- Send For Trouble Shooting Guide

NOT AFFILIATED WITH ANY OTHER MAIL ORDER TUBE COMPANY

EACH TUBE INDIVIDUALLY & ATTRACTIVELY BOXED & BRANDED RAD-TEL

Qty.	Type	Price	Qty.	Type	Price	Qty.	Type	Price	Qty.	Type	Price	Qty.	Type	Price	Qty.	Type	Price
—	0Z4	.79	—	5CL8	.76	—	6BJ7	.79	—	6EY6*	.75	—	12AE6	.43	—	12ENG	.78
—	1AX2	.62	—	5CM8*	.90	—	6BK7	.85	—	6F5GT	.39	—	12AE7	.94	—	12EZ6	.53
—	1B3	.79	—	5CQ8	.84	—	6BL7	1.00	—	6FE8	.75	—	12AF3	.73	—	12F8	.66
—	1DN5	.55	—	5CZ5*	.72	—	6BN4	.57	—	6GH8	.80	—	12AF6	.49	—	12FAG	.79
—	1G3*	.79	—	5EA8	.80	—	6BN6	.74	—	6GK6*	.79	—	12AJ6	.46	—	12FM6	.43
—	1J3*	.79	—	5EU8	.80	—	6BQ6	1.05	—	6GN8*	.94	—	12AL5	.45	—	12FR8	.91
—	1K3*	.79	—	5J6	.68	—	6BQ7	1.00	—	6HG	.58	—	12AL8	.95	—	12FX8	.85
—	1R5	.62	—	5T8	.81	—	6BS8	.90	—	6J5GT	.51	—	12AQ5	.60	—	12GC6	1.06
—	1S4	.59	—	5U4	.60	—	6BU8	.70	—	6J6	.67	—	12AT6	.43	—	12J8	.84
—	1S5	.51	—	5U8	.81	—	6BX7	1.02	—	6K6	.63	—	12AT7	.76	—	12K5	.65
—	1T4	.58	—	5V3	.90	—	6BY5	1.15	—	6L6	1.06	—	12AUG	.51	—	12L6	.58
—	1U4	.57	—	5V6	.56	—	6BY6	.54	—	6N7	.98	—	12AU7	.60	—	12SA7	.92
—	1U5	.50	—	5X8	.78	—	6BY8	.66	—	6S4	.51	—	12AV6	.41	—	12SF7	.69
—	1X2B	.82	—	5Y3	.46	—	6BZ6	.55	—	6SA7GT	.76	—	12AV7	.75	—	12SH7	.49
—	2AF4	.96	—	6A8G	1.20	—	6BZ7	1.01	—	6SG7GT	.41	—	12AX4	.67	—	12SJ7	.67
—	2BN4	.64	—	6AB4	.46	—	6BZ8	1.09	—	6SH7GT	.49	—	12AX7	.63	—	12SK7	.74
—	2EN5*	.45	—	6AC7	.96	—	6C4	.43	—	6SJ7	.88	—	12AY7	1.44	—	12SL7	.80
—	3AL5	.42	—	6AF3	.73	—	6CB6	.55	—	6SK7GT	.74	—	12AZ7	.86	—	12SN7	.67
—	3AU6	.51	—	6AF4	.97	—	6CD6	1.42	—	6SL7GT	.80	—	12B4	.63	—	12SQ7	.78
—	3AV6	.41	—	6AG5	.68	—	6CE5*	.57	—	6SN7GT	.65	—	12BA7	.84	—	12U7	.62
—	3BA6	.51	—	6AH4	.81	—	6CF6	.64	—	6SQ7	.73	—	12BD6	.50	—	12V6	.53
—	3BC5	.54	—	6AH6	.99	—	6CG7	.61	—	6T4	.99	—	12BE6	.53	—	12W6	.69
—	3BE6	.52	—	6AK5	.95	—	6CG8	.77	—	6T8	.85	—	12BF6	.44	—	12X4	.38
—	3BN6	.76	—	6AL5	.47	—	6CK4*	.70	—	6U8	.83	—	12BH7	.77	—	17AX4	.67
—	3BU8	.78	—	6AM8	.78	—	6CL8	.79	—	6VG6T	.54	—	12BK5	1.00	—	17BQ6	1.09
—	3BY6	.55	—	6A5	.53	—	6CM6	.64	—	6W4	.60	—	12BL6	.56	—	17DQ6	1.06
—	3BZ6	.55	—	6AR5	.55	—	6CM7	.66	—	6W6	.71	—	12BQ6	1.06	—	17W6	.70
—	3CB6	.54	—	6AS5	.60	—	6CM8*	.90	—	6X4	.39	—	12BR7	.74	—	18FW6*	.49
—	3CS6	.52	—	6AS6	.80	—	6CN7	.65	—	6X5GT	.53	—	12BV7	.78	—	18FY6*	.50
—	3DG4*	.85	—	6AT6	.43	—	6CQ8	.84	—	6X8	.80	—	12BY7	.77	—	18FX6*	.53
—	3DK6*	.60	—	6AT8	.79	—	6CR6	.51	—	7A8	.68	—	12BZ7	.75	—	19AU4	.83
—	3DT6	.50	—	6AU4	.82	—	6CS6	.57	—	7AU7	.61	—	12C5	.56	—	19BG6	1.39
—	3Q4	.63	—	6AU6	.52	—	6CS7	.69	—	7B6	.69	—	12CN5	.56	—		
—	3Q5	.80	—	6AU7	.61	—	6CU5	.58	—	7EY8*	.73	—	12CR6	.54	—		
—	3S4	.61	—	6AU8	.87	—	6CU6	1.08	—	7F8	.90	—	12CU5	.58	—		
—	3V4	.58	—	6AV6	.41	—	6CY5*	.70	—	7N7	.90	—	12CU6	1.06	—		
—	4BQ7	1.01	—	6AW8	.90	—	6CY7	.71	—	7S7	1.01	—	12CX6	.54	—		
—	4BZ7	.96	—	6AX4	.66	—	6DA4*	.68	—	7Y4	.69	—	12D4*	.69	—		
—	4BZ8	1.10	—	6AX5	.74	—	6DB5	.69	—	8AU8	.83	—	12DB5	.69	—		
—	4CS6	.61	—	6AX7	.64	—	6DB6	.51	—	8AW8	.93	—	12DE8	.75	—		
—	4DT6	.55	—	6AX8*	.92	—	6DE6	.58	—	8BQ5	.60	—	12DL8	.85	—		
—	5AM8	.79	—	6BA6	.50	—	6DG6	.59	—	8CG7	.62	—	12DQ6	1.04	—		
—	5AN8	.86	—	6BA8	.88	—	6DK6	.59	—	8CM7	.68	—	12DS7	.79	—		
—	5AQ5	.52	—	6BC5	.61	—	6DN6	1.55	—	8CN7	.97	—	12DT5*	.76	—		
—	5AS8*	.86	—	6BC7	.94	—	6DQ6	1.10	—	8CS7	.74	—	12DT7*	.79	—		
—	5AT8	.80	—	6BC8	.97	—	6DT6	.53	—	8CX8	.93	—	12DT8*	.79	—		
—	5AV8	1.01	—	6BD5	1.25	—	6DT8*	.79	—	8EB8	.94	—	12DU7	1.01	—		
—	5BC8	.79	—	6BE6	.55	—	6EA8	.79	—	8SN7	.66	—	12DW8*	.89	—		
—	5BE8	.83	—	6BF5	.90	—	6EB5*	.72	—	9CL8	.79	—	12DZ6	.56	—		
—	5BK7	.82	—	6BF6	.44	—	6EB8	.94	—	11CY7	.75	—	12ED5	.69	—		
—	5BQ7	.97	—	6BG6	1.66	—	6EM5*	.76	—	12A4	.60	—	12EG6	.54	—		
—	5BR8	.79	—	6BH6	.65	—	6EM7	.82	—	12AB5	.55	—	12EK6	.56	—		
—	5BT8*	.83	—	6BH8	.87	—	6EU8	.79	—	12AC6	.49	—	12EL6	.50	—		
—	5CG8	.76	—	6BJ6	.62	—	6EW6	.57	—	12AD6	.57	—	12EM6	.79	—		

New Tube Types Offered by Rad-Tel*

SPECIAL! New Low Prices

RAD-TEL POWER TRANSISTORS

SET TESTED* — Family 2N155, 2N178, 2N242, 2N255, 2N256, 2N307, 2N554, etc. ea. **49c**

SET TESTED* — Family 2N173, 2N277, 2N441, 2N442, DS501. ea. **79c**

SET TESTED* — General replacement in Transistor Radios and experimenters projects. ea. **29c**

*Set tested in Amer. Car Radio. All Transistors PNP Germanium. Factory tested to Rad-Tel specifications.



RAD-TEL TUBE CO.

Dept. RE-4 55 CHAMBERS ST., NEWARK 5, NEW JERSEY

TERMS: 25% deposit must accompany all orders, balance COO. Orders under \$5: add \$1 handling charge plus postage. Orders over \$5: plus postage. Approx. 8 tubes per 1 lb. Subject to prior sale. No COD's outside continental USA.

INTERNATIONAL'S **Executive** **MODEL 100**



**citizens
band
transceiver**

A precision engineered transceiver for Citizens Band licensees seeking outstanding design and performance. Tunable dual conversion superheterodyne receiver covering all 23 channels. Two crystal control receive positions. Push-to-talk operation. Three way power supply for 6/12 vdc and 115 vac. Five watts plate input. Certified tolerance $\pm .005\%$. Size 5½" x 8½" x 9" deep.

Complete with 1 transmit crystal, 1 receive crystal, new style ceramic microphone and coil cord.....\$199.50

Advanced engineering featured in the Executive Model 100

- NEW crystal filter minimizes adjacent channel interference.
- NEW built-in calibration circuit.
- NEW International NR squelch.
- NEW 12 position crystal control transmit channel selector.
- NEW front panel microphone jack.
- NEW provision for connecting external speaker and S/meter.

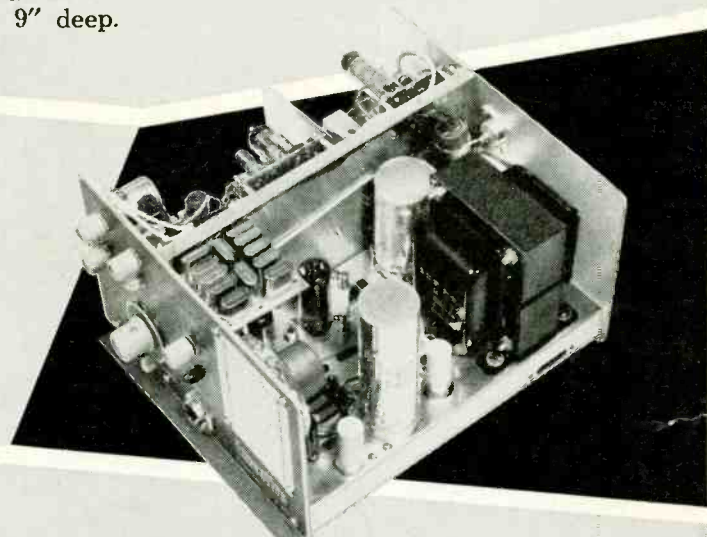

FREE INTERNATIONAL'S 1962 CATALOG

Your buying guide for precision radio crystals and quality electronic equipment. Complete data on International's Citizens Band transceivers and accessories.

Send for it TODAY!



International Crystal Mfg. Co., Inc.
18 North Lee, Oklahoma City, Okla.

Rush FREE 1962 Catalog RE4

Name _____
Please print

Address _____

City _____ Zone _____ State _____

INTERNATIONAL Crystal Manufacturing Co., Inc. • 18 North Lee • Oklahoma City, Okla.

TOP

Higher Gain

Lower Noise

OF THE HEAP

85% of all TV servicemen prefer Standard turret type replacement TV tuners.

1 year guarantee backed by the world's largest TV tuner manufacturer.

Trade-in allowance for the defective tuner being replaced.

In TV It's Standard

See your local authorized Standard Coil Distributor

standard kollsman

INDUSTRIES INC.

FORMERLY STANDARD COIL PRODUCTS CO., INC., MELROSE PARK, ILLINOIS

Important News for Independent TV-Radio-HiFi Service Dealers...

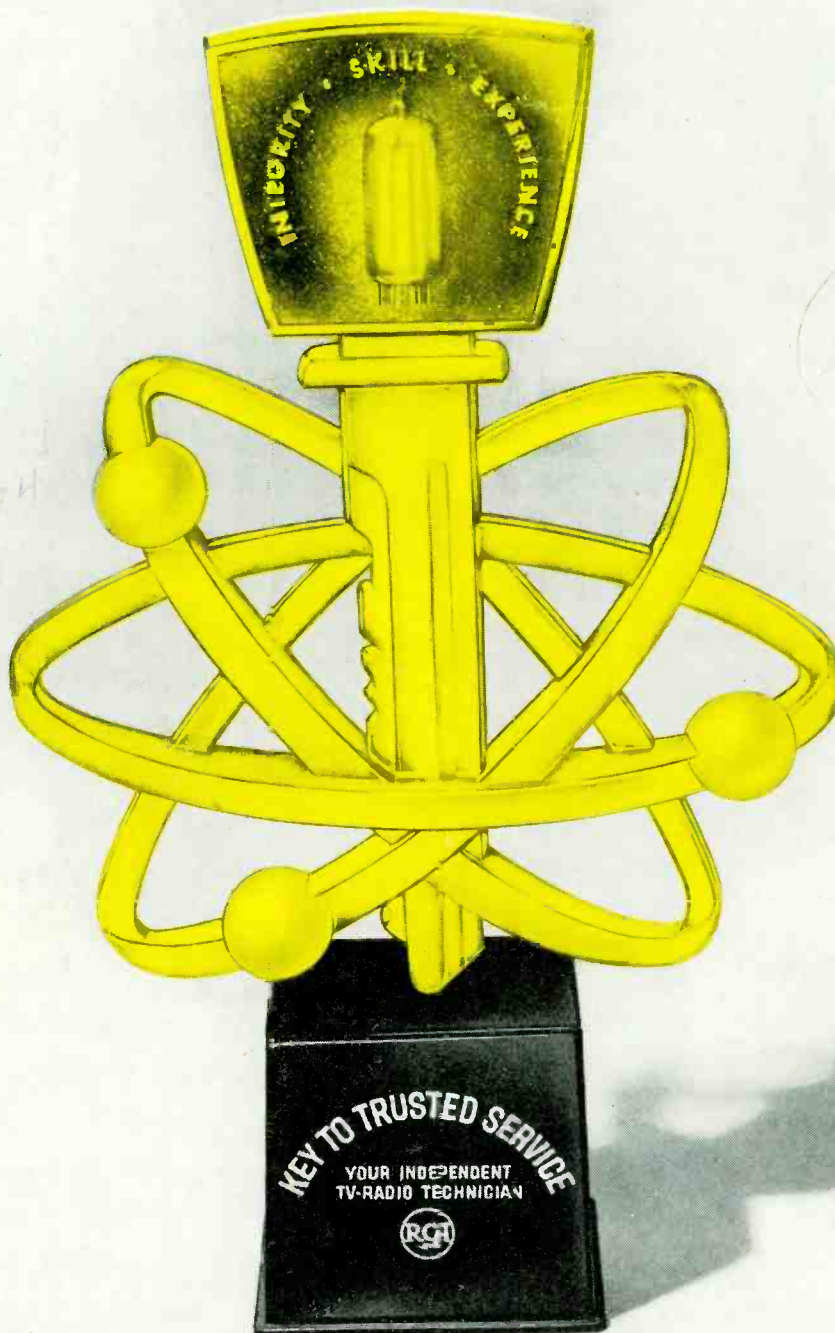

RCA Announces A Major New Program

THIS PROGRAM WILL...

- Identify You as a Trusted Service Dealer
- Highlight Your Technical Competence
- Enhance Your Community Prestige
- Symbolize Your Professional Integrity
- Build Your Public Recognition and Acceptance
- Help Increase Your Business Volume and Profits

See your Authorized RCA Tube Distributor for full details on how you can participate in the *RCA Key to Trusted Service Program*, which is heavily advertised to consumers through TV Guide and NBC-TV.

RCA ELECTRON TUBE DIVISION,
HARRISON, N. J.



The Most Trusted Name in Electronics